



Package: SOT-363



### Product Description

The SGA2263Z is a high performance SiGe HBT MMIC Amplifier. A Darlington configuration featuring one-micron emitters provides high  $F_T$  and excellent thermal performance. The heterojunction increases breakdown voltage and minimizes leakage current between junctions. Cancellation of emitter junction non-linearities results in higher suppression of intermodulation products. Only two DC-blocking capacitors, a bias resistor, and an optional RF choke are required for operation.

#### Optimum Technology Matching® Applied

- GaAs HBT
- GaAs MESFET
- InGaP HBT
- SiGe BiCMOS
- Si BiCMOS
- SiGe HBT
- GaAs pHEMT
- Si CMOS
- Si BJT
- GaN HEMT
- RF MEMS

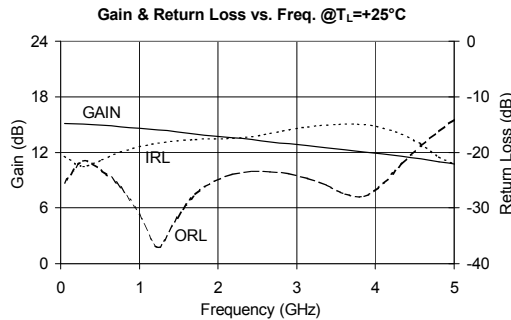

### Features

- High Gain: 13.8 dB at 1950 MHz
- Cascadable 50Ω
- Operates from Single Supply
- Low Thermal Resistance Package

### Applications

- PA Driver Amplifier
- Cellular, PCS, GSM, UMTS
- IF Amplifier
- Wireless Data, Satellite

Parameter	Specification			Unit	Condition
	Min.	Typ.	Max.		
Small Signal Gain	13	14.7	16.2	dB	850 MHz
		13.5		dB	1950 MHz
		13.2		dB	2400 MHz
Output Power at 1dB Compression		7.5		dBm	850 MHz
		6.1		dBm	1950 MHz
Output Third Intercept Point		20.2		dBm	850 MHz
		18.0		dBm	1950 MHz
Bandwidth Determined by Return Loss		5000		MHz	>10 dB
Input Return Loss		17.6		dB	1950 MHz
Output Return Loss		25.3		dB	1950 MHz
Noise Figure		3.5		dB	1950 MHz
Device Operating Voltage	1.9	2.2	2.5	V	
Device Operating Current	17	20	23	mA	
Thermal Resistance		255		°C/W	junction - lead

Test Conditions:  $V_S=5V$ ,  $I_D=20mA$  Typ.,  $OIP_3$  Tone Spacing=1MHz,  $P_{OUT}$  per tone=-10dBm,  $R_{BIAS}=140\Omega$ ,  $T_L=25^\circ C$ ,  $Z_S=Z_L=50\Omega$

## Absolute Maximum Ratings

Parameter	Rating	Unit
Max Device Current ( $I_D$ )	40	mA
Max Device Voltage ( $V_D$ )	4	V
Max RF Input Power	+18	dBm
Max Junction Temp ( $T_J$ )	+150	°C
Operating Temp Range ( $T_L$ )	-55 to +110	°C
Max Storage Temp	+150	°C

Operation of this device beyond any one of these limits may cause permanent damage. For reliable continuous operation, the device voltage and current must not exceed the maximum operating values specified in the table on page one.

Bias Conditions should also satisfy the following expression:

$$I_D V_D < (T_J - T_L) / R_{TH}, J-H$$



**Caution!** ESD sensitive device.

Exceeding any one or a combination of the Absolute Maximum Rating conditions may cause permanent damage to the device. Extended application of Absolute Maximum Rating conditions to the device may reduce device reliability. Specified typical performance or functional operation of the device under Absolute Maximum Rating conditions is not implied.

RoHS status based on EU Directive 2011/65/EU (at time of this document revision).

The information in this publication is believed to be accurate and reliable. However, no responsibility is assumed by RF Micro Devices, Inc. ("RFMD") for its use, nor for any infringement of patents, or other rights of third parties, resulting from its use. No license is granted by implication or otherwise under any patent or patent rights of RFMD. RFMD reserves the right to change component circuitry, recommended application circuitry and specifications at any time without prior notice.



RFMD Green: RoHS compliant per EU Directive 2011/65/EU, halogen free per IEC 61249-2-21, < 1000 ppm each of antimony trioxide in polymeric materials and red phosphorus as a flame retardant, and <2% antimony in solder.

## Typical Performance at Key Operating Frequencies

Parameter	Unit	100MHz	500MHz	850MHz	1950MHz	2400MHz	3500MHz
Small Signal Gain	dB		14.9	14.7	13.5	13.2	
Output Third Order Intercept Point	dBm		20.4	20.2	18.0	16.9	
Output Power at 1dB Compression	dBm		7.6	7.5	6.1	5.4	
Input Return Loss	dB	21.3	21.5	19.6	17.6	17.2	15.0
Output Return Loss	dB	24.1	23.0	27.8	25.3	23.4	26.7
Reverse Isolation	dB	17.8	18.5	18.7	19.1	19.2	19.2
Noise Figure	dB		3.3	3.2	3.5	4.0	

Test Conditions:  $V_S = 5V$ ,  $I_D = 20mA$  Typ.,  $OIP_3$  Tone Spacing = 1MHz,  $P_{OUT}$  per tone = -10dBm,  $R_{BIAS} = 140\Omega$ ,  $T_L = 25^\circ C$ ,  $Z_S = Z_L = 50\Omega$

**$OIP_3$  vs. Frequency**  
 $V_D = 2.2V$ ,  $I_D = 20mA$

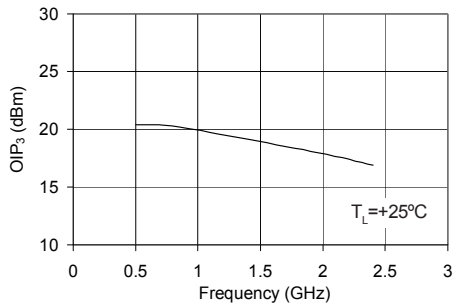

**$P_{1dB}$  vs. Frequency**  
 $V_D = 2.2V$ ,  $I_D = 20mA$

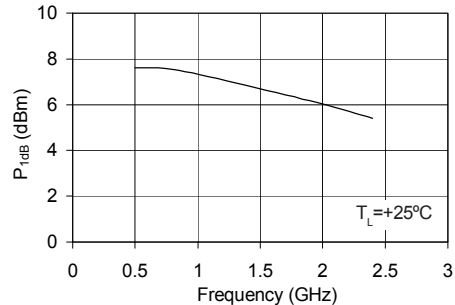

**Noise Figure vs. Frequency**  
 $V_D = 2.2V$ ,  $I_D = 20mA$

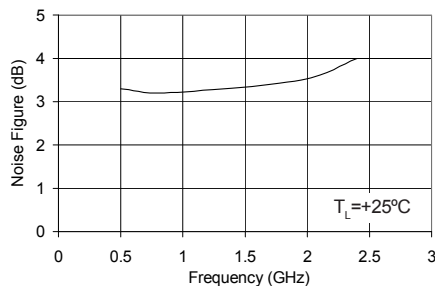

Typical RF Performance Over Temperature (Bias:  $V_D=2.2V$ ,  $I_D=20mA$  (Typ.))

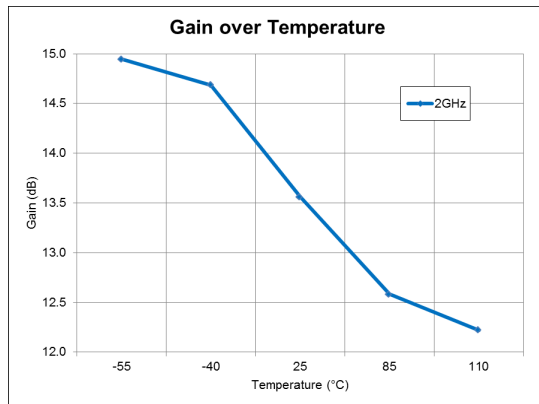
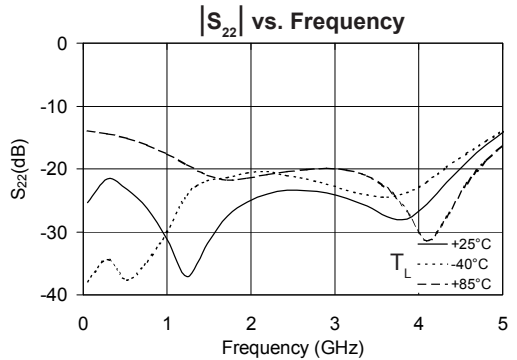
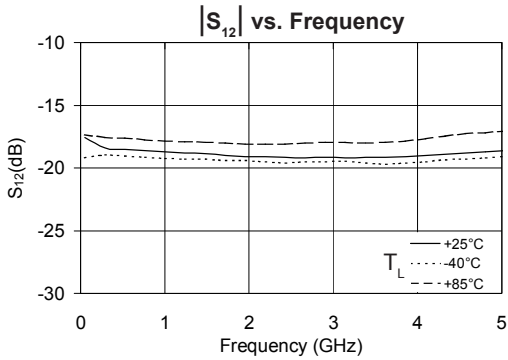
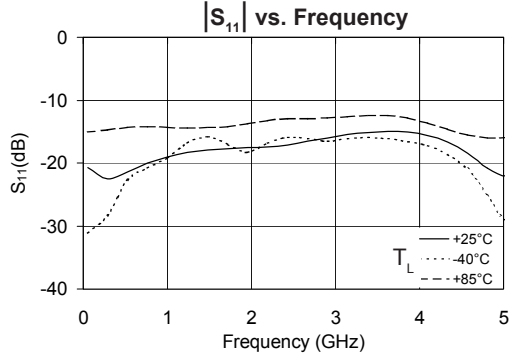
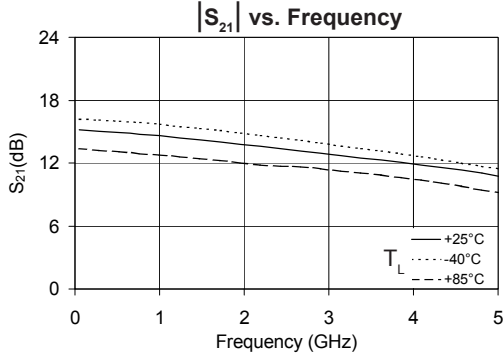

## Application Circuit

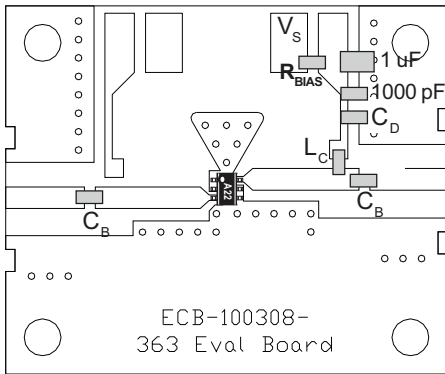
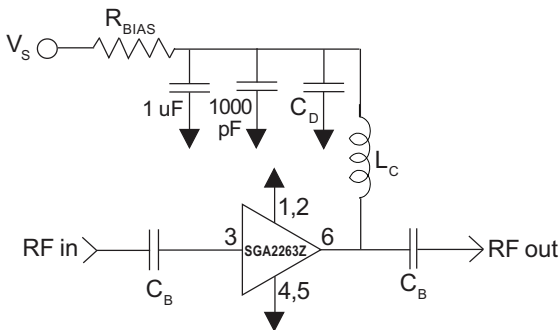

Reference Designator	Frequency (Mhz)				
	500	850	1950	2400	3500
C <sub>B</sub>	220 pF	100 pF	68 pF	56 pF	39 pF
C <sub>D</sub>	100 pF	68 pF	22 pF	22 pF	15 pF
L <sub>C</sub>	68 nH	33 nH	22 nH	18 nH	15 nH

Recommended Bias Resistor Values for I <sub>D</sub> =20mA					
$R_{BIAS} = (V_S - V_D) / I_D$					
Supply Voltage(V <sub>S</sub> )	5 V	6 V	8 V	10 V	
R <sub>BIAS</sub>	140 Ω	200 Ω	300 Ω	390 Ω	

Note: R<sub>BIAS</sub> provides DC bias stability over temperature.

### Mounting Instructions

1. Use a large ground pad area near device pins 1, 2, 4, and 5 with many plated through-holes as shown.
3. We recommend 1 or 2 ounce copper. Measurements for this data sheet were made on a 31 mil thick FR-4 board with 1 ounce copper on both sides.

### SOT-363 PCB Pad Layout

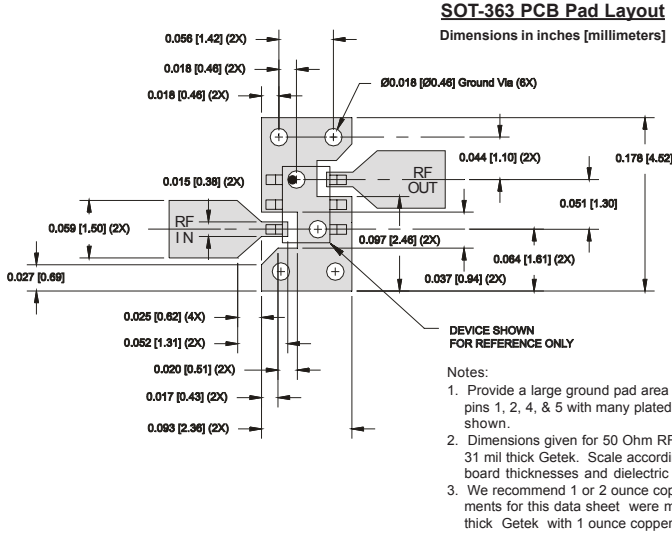

### SOT-363 Nominal Package Dimensions

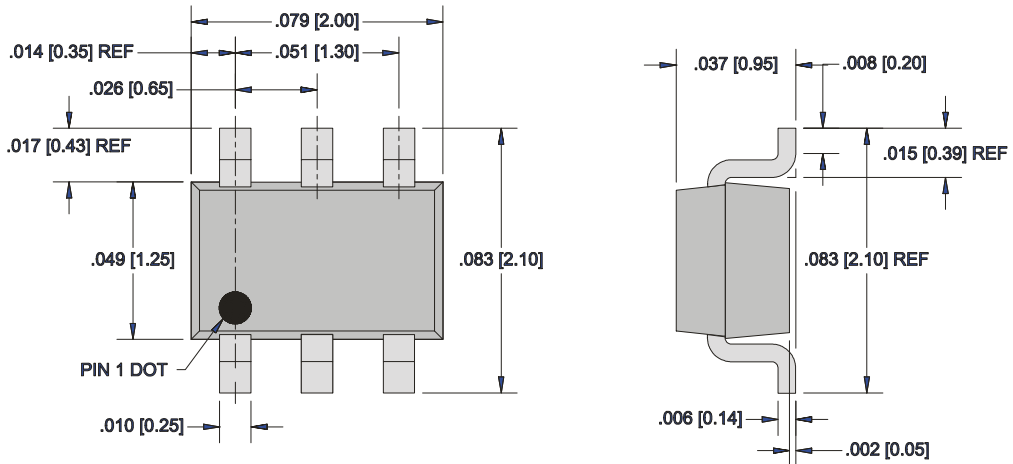

## Part Identification Marking

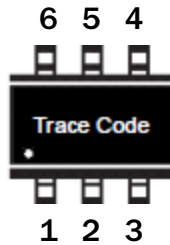

## Ordering Information

Ordering Code	Description
SGA2263Z	7" Reel with 3000 pieces
SGA2263ZSQ	Sample bag with 25 pieces
SGA2263ZSR	7" Sample reel with 100 pieces
SGA2263ZPCK1	850MHz, 5V Operation PCBA with 5-piece sample bag