

HEXFET® Power MOSFET

V_{DS}	20	V
$V_{GS\ max}$	±12	V
$R_{DS(on)\ max}$ (@ $V_{GS} = 4.5V$)	2.5	mΩ
$R_{DS(on)\ max}$ (@ $V_{GS} = 2.5V$)	3.5	mΩ
Q_g (typical)	52	nC
I_D (@ $T_{c(Bottom)} = 25^\circ C$)	40 ⑥	A

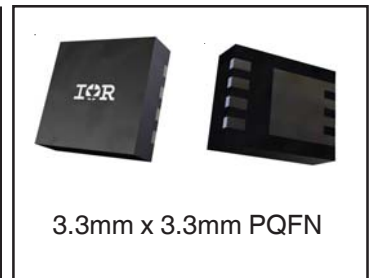
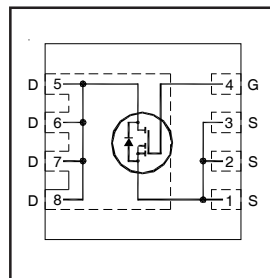

Applications

- Battery Operated DC Motor Inverter MOSFET
- Secondary Side Synchronous Rectification MOSFET

Features and Benefits

Features

Low R_{DSon} (<2.5mΩ)
Low Thermal Resistance to PCB (<3.4°C/W)
Low Profile (<1.0mm)
Industry-Standard Pinout
Compatible with Existing Surface Mount Techniques
RoHS Compliant Containing no Lead, no Bromide and no Halogen
MSL1, Industrial Qualification

results in
⇒

Benefits

Lower Conduction Losses
Enable better thermal dissipation
Increased Power Density
Multi-Vendor Compatibility
Easier Manufacturing
Environmentally Friendlier
Increased Reliability

Orderable part number	Package Type	Standard Pack		Note
		Form	Quantity	
IRLHM620TRPBF	PQFN 3.3mm x 3.3mm	Tape and Reel	4000	
IRLHM620TR2PBF	PQFN 3.3mm x 3.3mm	Tape and Reel	400	EOL notice #259

Absolute Maximum Ratings

	Parameter	Max.	Units
V_{DS}	Drain-to-Source Voltage	20	V
V_{GS}	Gate-to-Source Voltage	±12	
I_D @ $T_A = 25^\circ C$	Continuous Drain Current, V_{GS} @ 4.5V	26	A
I_D @ $T_A = 70^\circ C$	Continuous Drain Current, V_{GS} @ 4.5V	21	
I_D @ $T_{c(Bottom)} = 25^\circ C$	Continuous Drain Current, V_{GS} @ 4.5V	40	
I_D @ $T_{c(Bottom)} = 100^\circ C$	Continuous Drain Current, V_{GS} @ 4.5V	40	
I_{DM}	Pulsed Drain Current ①	160	
P_D @ $T_A = 25^\circ C$	Power Dissipation ⑤	2.7	W
P_D @ $T_{c(Bottom)} = 25^\circ C$	Power Dissipation ⑤	37	
	Linear Derating Factor ⑤	0.022	W/°C
T_J	Operating Junction and	-55 to + 150	°C
T_{STG}	Storage Temperature Range		

Notes ① through ⑤ are on page 9

Static @ T_J = 25°C (unless otherwise specified)

	Parameter	Min.	Typ.	Max.	Units	Conditions
BV _{DSS}	Drain-to-Source Breakdown Voltage	20	—	—	V	V _{GS} = 0V, I _D = 250μA
ΔBV _{DSS} /ΔT _J	Breakdown Voltage Temp. Coefficient	—	5.4	—	mV/°C	Reference to 25°C, I _D = 1mA
R _{DS(on)}	Static Drain-to-Source On-Resistance	—	1.5	2.2	mΩ	V _{GS} = 10V, I _D = 20A ③
		—	1.8	2.5		V _{GS} = 4.5V, I _D = 20A ③
		—	2.7	3.5		V _{GS} = 2.5V, I _D = 20A ③
V _{GS(th)}	Gate Threshold Voltage	0.5	0.8	1.1	V	V _{DS} = V _{GS} , I _D = 50μA
ΔV _{GS(th)}	Gate Threshold Voltage Coefficient	—	-4.3	—	mV/°C	
I _{DSS}	Drain-to-Source Leakage Current	—	—	1.0	μA	V _{DS} = 16V, V _{GS} = 0V
		—	—	150		V _{DS} = 16V, V _{GS} = 0V, T _J = 125°C
I _{GSS}	Gate-to-Source Forward Leakage	—	—	100	nA	V _{GS} = 12V
	Gate-to-Source Reverse Leakage	—	—	-100		V _{GS} = -12V
g _{fs}	Forward Transconductance	58	—	—	S	V _{DS} = 10V, I _D = 20A
Q _g	Total Gate Charge	—	52	78	nC	V _{DS} = 10V
Q _{gs}	Gate-to-Source Charge	—	6.3	—		V _{GS} = 4.5V
Q _{gd}	Gate-to-Drain Charge	—	25	—		I _D = 20A (See Fig.17 & 18)
R _G	Gate Resistance	—	2.6	—	Ω	
t _{d(on)}	Turn-On Delay Time	—	7.5	—	ns	V _{DD} = 10V, V _{GS} = 4.5V
t _r	Rise Time	—	25	—		I _D = 20A
t _{d(off)}	Turn-Off Delay Time	—	57	—		R _G = 1.0Ω
t _f	Fall Time	—	37	—		See Fig.15
C _{iss}	Input Capacitance	—	3620	—	pF	V _{GS} = 0V
C _{oss}	Output Capacitance	—	900	—		V _{DS} = 10V
C _{rss}	Reverse Transfer Capacitance	—	620	—		f = 1.0MHz

Avalanche Characteristics

	Parameter	Typ.	Max.	Units
E _{AS}	Single Pulse Avalanche Energy ②	—	120	mJ
I _{AR}	Avalanche Current ①	—	20	A

Diode Characteristics

	Parameter	Min.	Typ.	Max.	Units	Conditions
I _S	Continuous Source Current (Body Diode)	—	—	40	A	MOSFET symbol showing the integral reverse p-n junction diode. 
I _{SM}	Pulsed Source Current (Body Diode) ①	—	—	160		
V _{SD}	Diode Forward Voltage	—	—	1.2	V	T _J = 25°C, I _S = 20A, V _{GS} = 0V ③
t _{rr}	Reverse Recovery Time	—	41	62	ns	T _J = 25°C, I _F = 20A, V _{DD} = 10V
Q _{rr}	Reverse Recovery Charge	—	68	100	nC	di/dt = 220A/μs ③
t _{on}	Forward Turn-On Time	Time is dominated by parasitic Inductance				

Thermal Resistance

	Parameter	Typ.	Max.	Units
R _{θJC} (Bottom)	Junction-to-Case ④	—	3.4	°C/W
R _{θJC} (Top)	Junction-to-Case ④	—	37	
R _{θJA}	Junction-to-Ambient ⑤	—	46	
R _{θJA} (<10s)	Junction-to-Ambient ⑤	—	31	

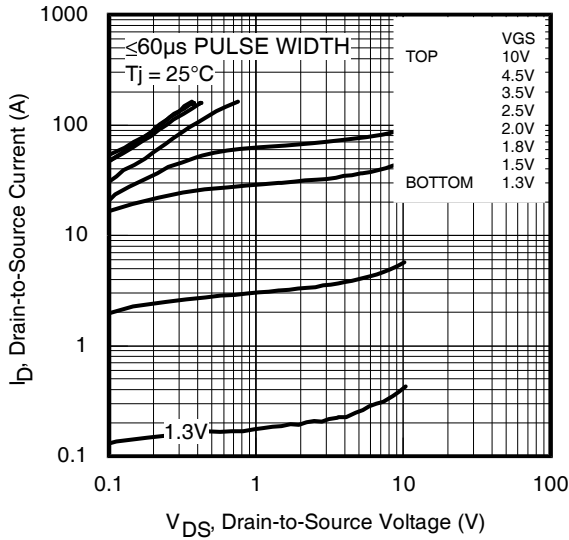

Fig 1. Typical Output Characteristics

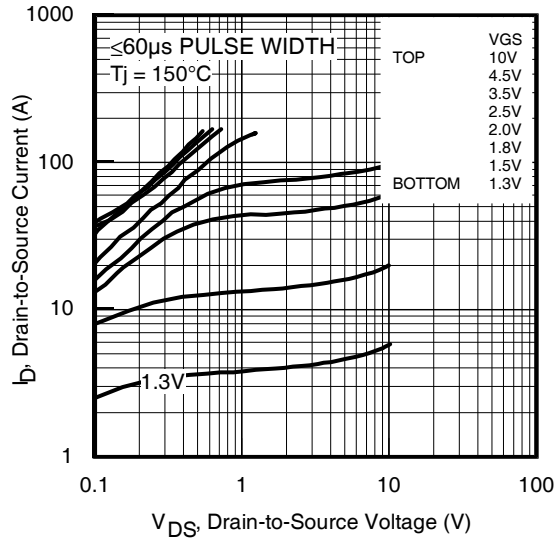

Fig 2. Typical Output Characteristics

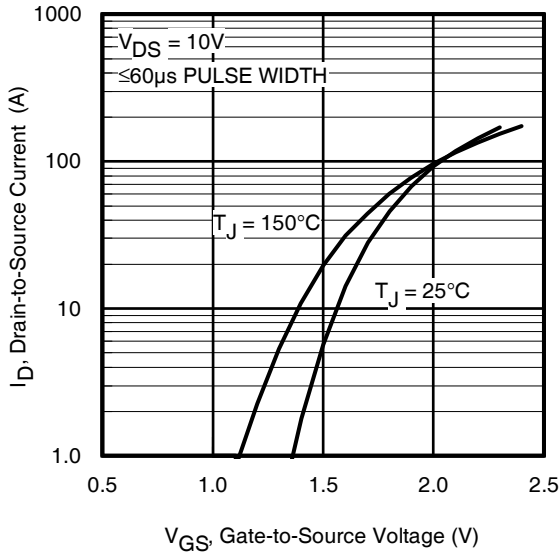

Fig 3. Typical Transfer Characteristics

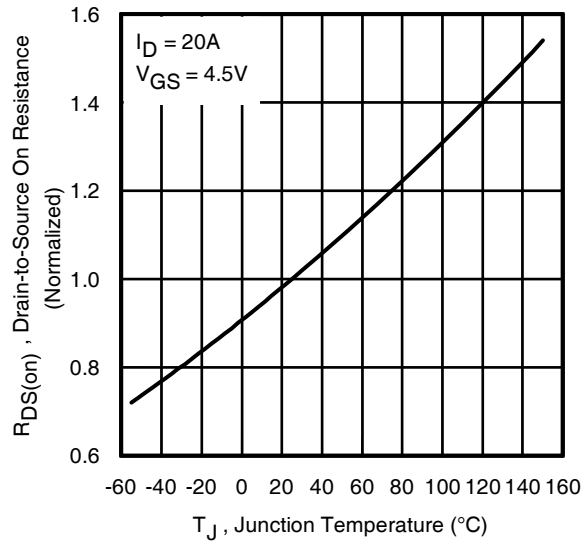

Fig 4. Normalized On-Resistance vs. Temperature

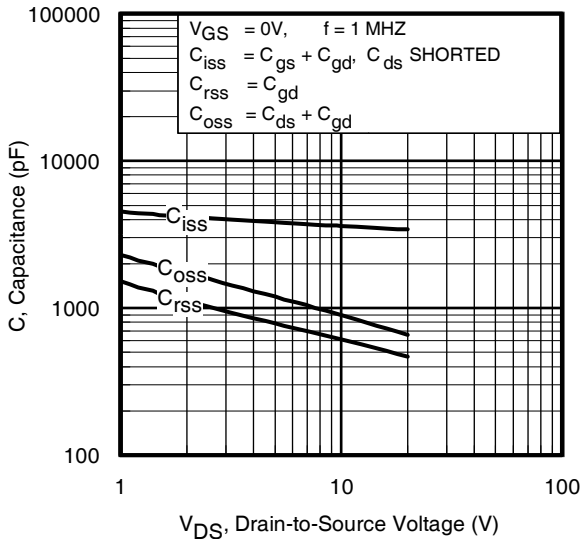

Fig 5. Typical Capacitance vs. Drain-to-Source Voltage

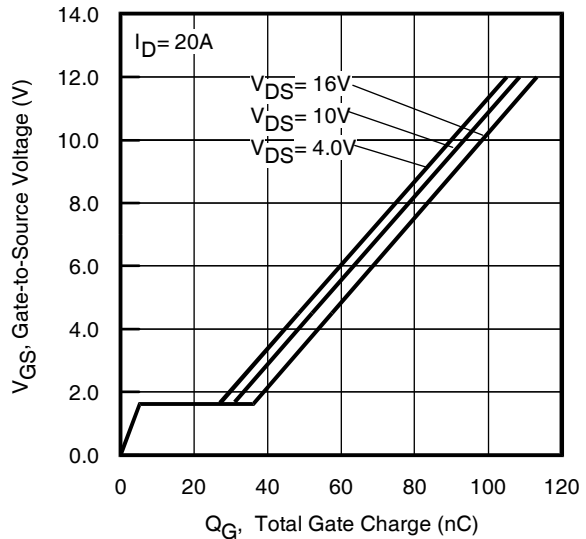

Fig 6. Typical Gate Charge vs. Gate-to-Source Voltage

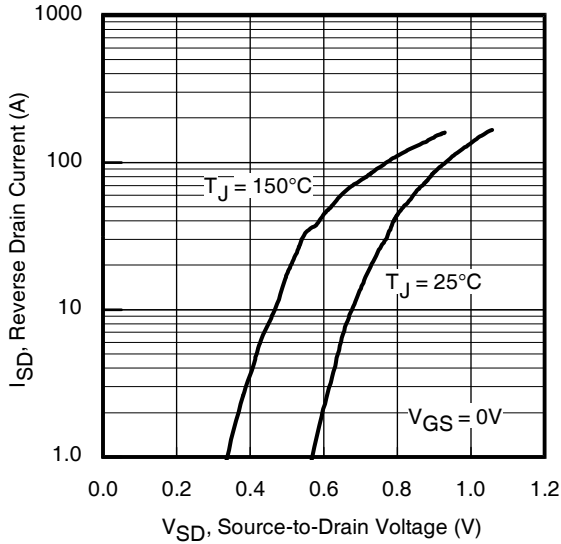

Fig 7. Typical Source-Drain Diode Forward Voltage

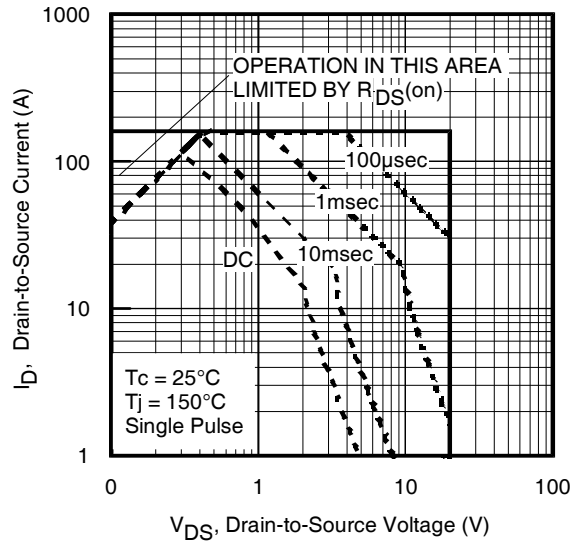

Fig 8. Maximum Safe Operating Area

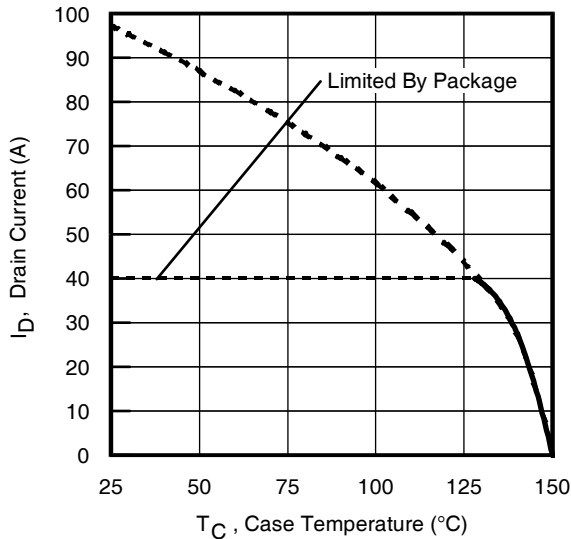

Fig 9. Maximum Drain Current vs. Case (Bottom) Temperature

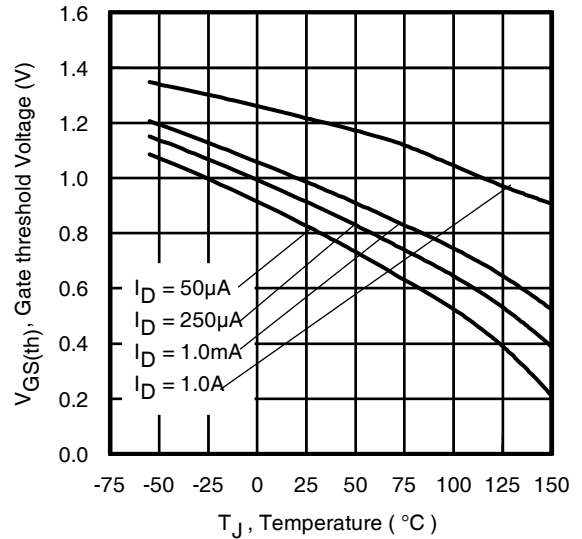

Fig 10. Threshold Voltage vs. Temperature

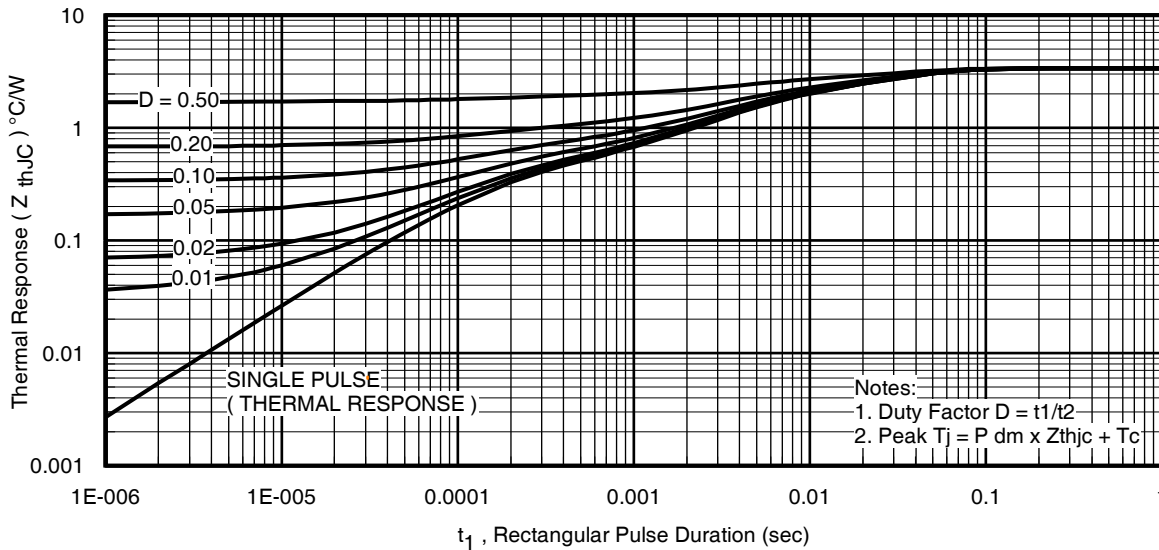

Fig 11. Maximum Effective Transient Thermal Impedance, Junction-to-Case (Bottom)

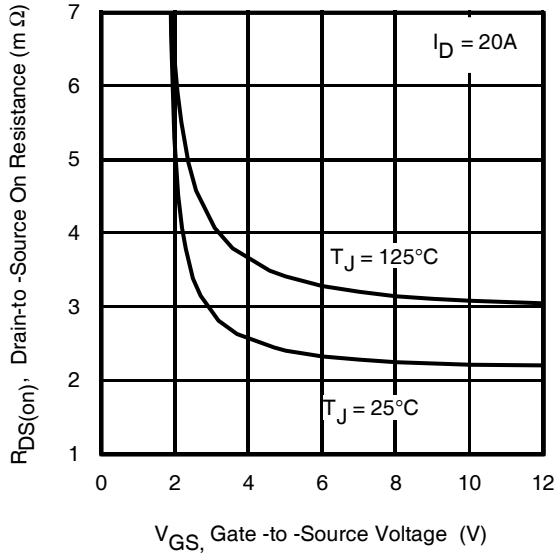

Fig 12. On-Resistance vs. Gate Voltage

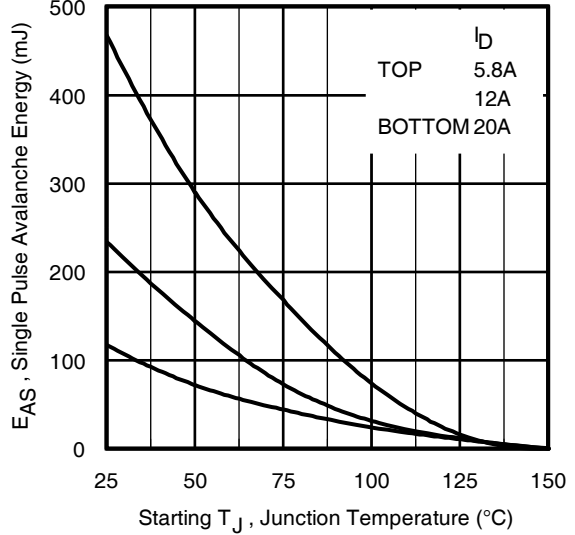

Fig 13. Maximum Avalanche Energy vs. Drain Current

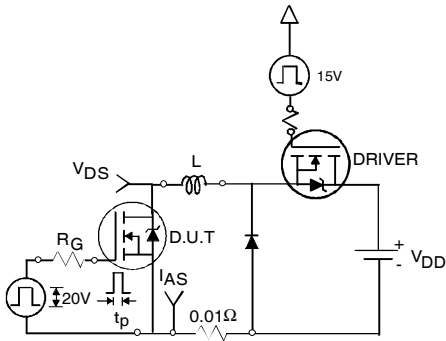

Fig 14a. Unclamped Inductive Test Circuit

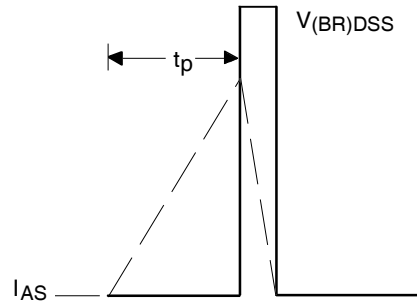

Fig 14b. Unclamped Inductive Waveforms

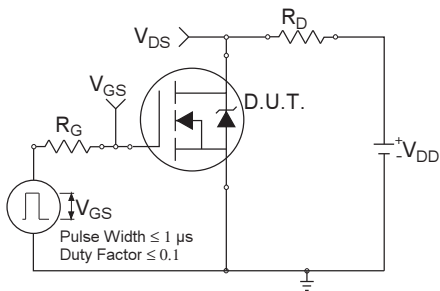

Fig 15a. Switching Time Test Circuit

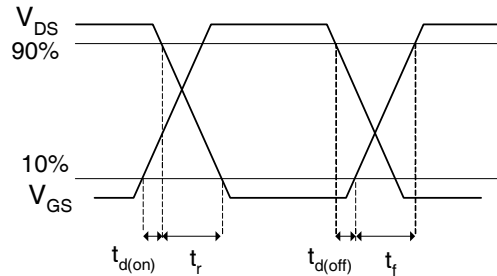
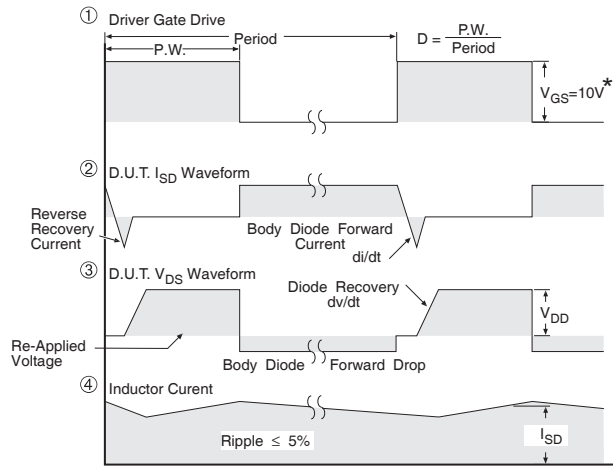
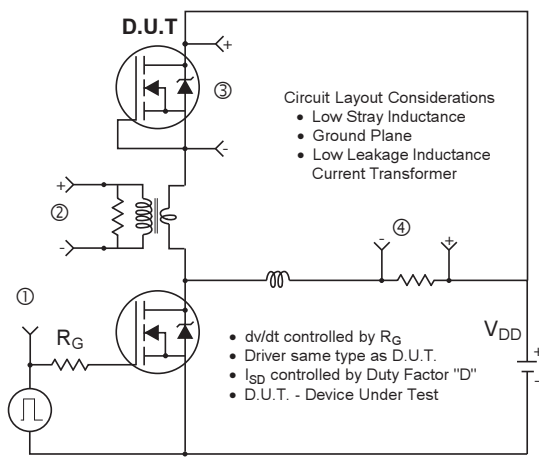

Fig 15b. Switching Time Waveforms



* $V_{GS} = 5V$ for Logic Level Devices

Fig 16. Peak Diode Recovery dv/dt Test Circuit for N-Channel HEXFET[®] Power MOSFETs

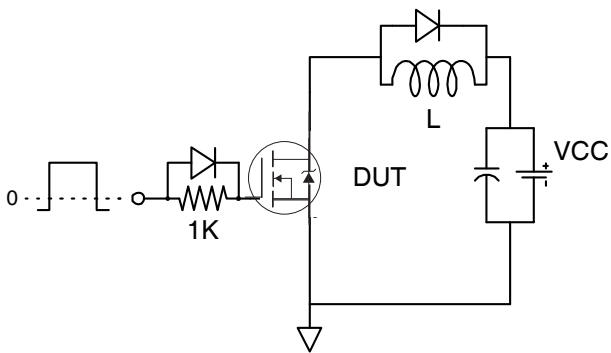

Fig 17. Gate Charge Test Circuit

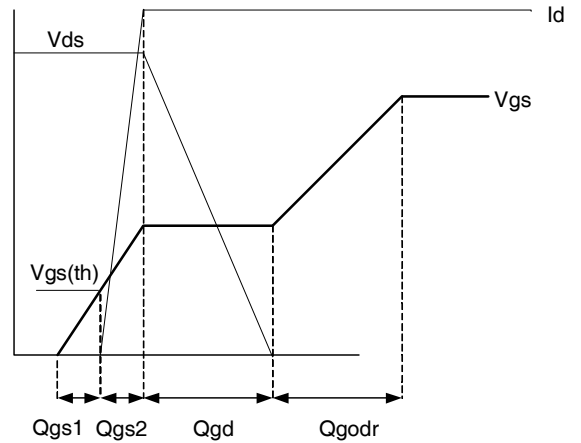
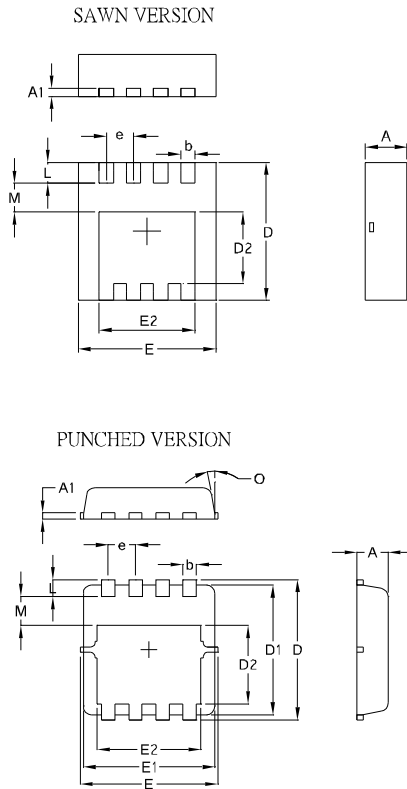

Fig 18. Gate Charge Waveform

PQFN 3.3x3.3 Outline Package Details



SYMBOL	COMMON			
	MM		INCH	
	MIN.	MAX.	MIN.	MAX.
A	0.70	1.05	0.0276	0.0413
A1	0.12	0.39	0.0047	0.0154
b	0.25	0.39	0.0098	0.0154
D	3.20	3.45	0.1260	0.1358
D1	3.00	3.20	0.1181	0.1417
D2	1.69	2.20	0.0665	0.0866
E	3.20	3.40	0.1260	0.1339
E1	3.00	3.20	0.1181	0.1417
E2	2.15	2.59	0.0846	0.1020
e	0.65 BSC		0.0256 BSC	
L	0.15	0.55	0.0059	0.0217
M	0.59	—	0.0232	—
O	9Deg	12Deg	9Deg	12Deg

For more information on board mounting, including footprint and stencil recommendation, please refer to application note AN-1136:
<http://www.irf.com/technical-info/appnotes/an-1136.pdf>
 For more information on package inspection techniques, please refer to application note AN-1154:
<http://www.irf.com/technical-info/appnotes/an-1154.pdf>

PQFN 3.3x3.3 Outline Part Marking

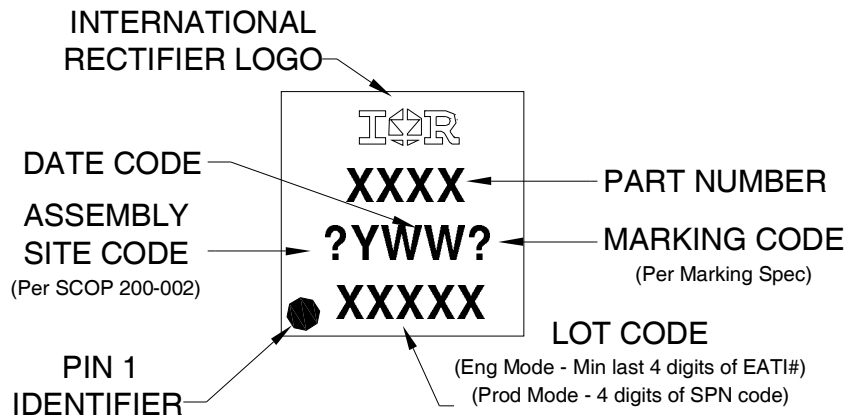

Note: For the most current drawing please refer to IR website at: <http://www.irf.com/package/>

PQFN 3.3x3.3 Outline Tape and Reel

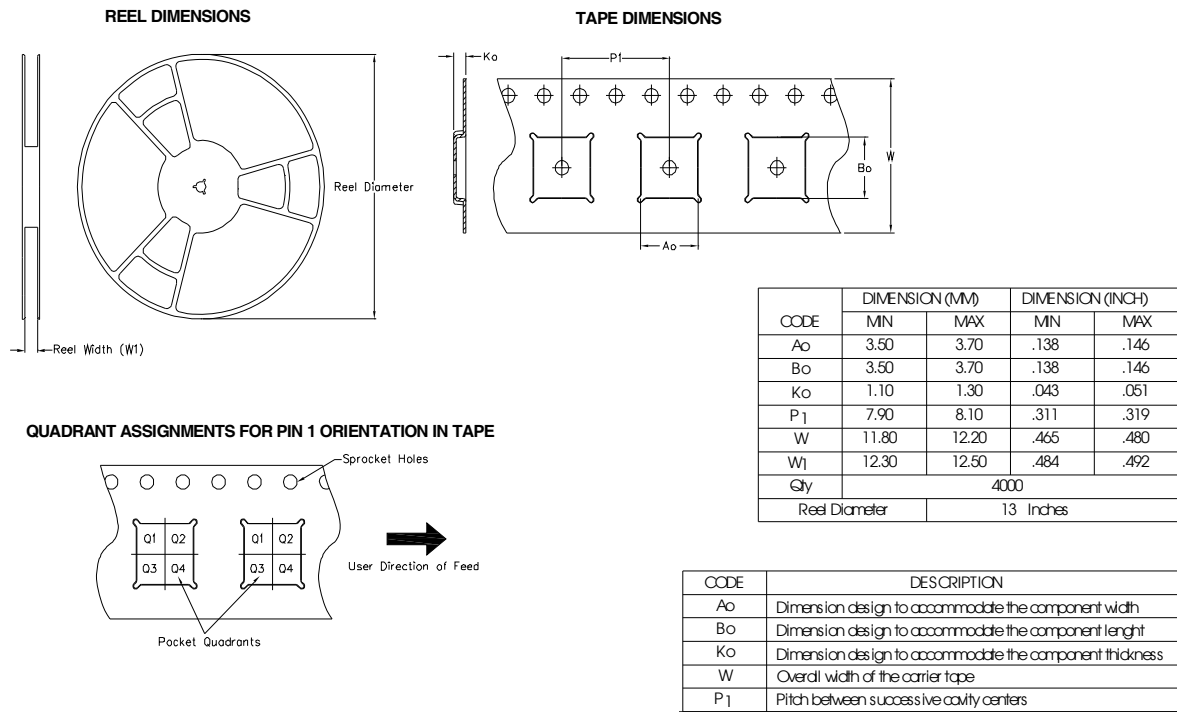

Note: For the most current drawing please refer to IR website at: <http://www.irf.com/package/>

Qualification information[†]

Qualification level	Industriid ^{††} (per JEDEC JESD47F ^{†††} guidelines)	
Moisture Sensitivity Level	PQFN 3.3mm x 3.3mm	MSL1 (per JEDEC J-STD-020D ^{†††})
RoHS compliant	Yes	

† Qualification standards can be found at International Rectifier’s web site
<http://www.irf.com/product-info/reliability>

†† Higher qualification ratings may be available should the user have such requirements.
 Please contact your International Rectifier sales representative for further information:
<http://www.irf.com/whoto-call/salesrep/>

††† Applicable version of JEDEC standard at the time of product release.

Notes:

- ① Repetitive rating; pulse width limited by max. junction temperature.
- ② Starting $T_J = 25^{\circ}\text{C}$, $L = 0.59\text{mH}$, $R_G = 50\Omega$, $I_{AS} = 20\text{A}$.
- ③ Pulse width $\leq 400\mu\text{s}$; duty cycle $\leq 2\%$.
- ④ R_{θ} is measured at T_J of approximately 90°C .
- ⑤ When mounted on 1 inch square 2 oz copper pad on 1.5x1.5 in. board of FR-4 material.
- ⑥ Calculated continuous current based on maximum allowable junction temperature. Package is limited to 40A by production test capability.

Revision History

Date	Comment
1/14/2014	<ul style="list-style-type: none"> • Updated ordering information to reflect the End-Of-Life (EOL) of the mini-reel option (EOL notice #259). • Updated data sheet with the new IR corporate template.
5/29/2014	<ul style="list-style-type: none"> • Added R_{dson} typical = "1.5mΩ", Max = "2.2mΩ" @ $V_{GS}=10\text{V}$, $I_D=20\text{A}$ on page 2. • Updated R_{dson} typical from "2mΩ" to "1.8mΩ" @ $V_{GS}=4.5\text{V}$, $I_D=20\text{A}$ on page 2. • Updated package outline and tape and Reel on page 7 & 8.