

**100V INPUT, 12V 30mA REGULATOR TRANSISTOR**

**Description**

The ZXTR2012Z monolithically integrates a transistor, Zener diode and resistor to function as a high voltage linear regulator. The device regulates with a 12V nominal output at 15mA. It is designed for use in high voltage applications where standard linear regulators cannot be used. This function is fully integrated into a SOT89 package, minimizing PCB area and reducing number of components when compared with a multi-chip discrete solution.

**Applications**

- Supply voltage regulation in:
- Networking
  - Telecom
  - Power Over Ethernet (PoE)

**Features**

- Series Linear Regulator Using Emitter-Follower Stage
- Input Voltage = 15V to 100V
- Output Voltage = 12V ± 10%
- Fully integrated into a SOT89 Package
- **Totally Lead-Free & Fully RoHS compliant (Notes 1 & 2)**
- **Halogen and Antimony Free. "Green" Device (Note 3)**
- **Qualified to AEC-Q101 Standards for High Reliability**

**Mechanical Data**

- Case: SOT89
- Case Material: Molded Plastic. "Green" Molding Compound.
- UL Flammability Rating 94V-0
- Moisture Sensitivity: Level 1 per J-STD-020
- Terminals: Finish - Matte Tin Plated Leads, Solderable per MIL-STD-202, Method 208 
- Weight: 0.052 grams (approximate)

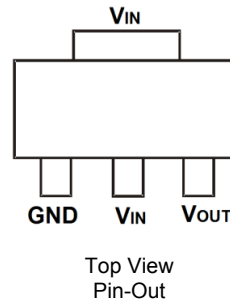
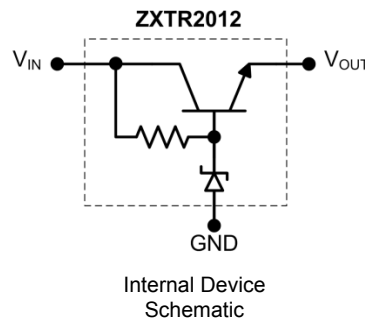
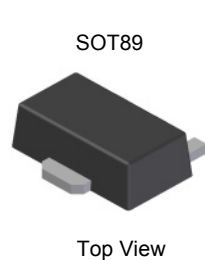

Pin Name	Pin Function
V <sub>IN</sub>	Input Supply
GND	Power Ground
V <sub>OUT</sub>	Voltage Output

**Ordering Information** (Note 4)

Product	Package	Marking	Reel size (inches)	Tape width (mm)	Quantity per reel
ZXTR2012Z-7	SOT89	1T4	7	12	1,000
ZXTR2012Z-13	SOT89	1T4	13	12	2,500

- Notes:
1. No purposely added lead. Fully EU Directive 2002/95/EC (RoHS) & 2011/65/EU (RoHS 2) compliant.
  2. See [http://www.diodes.com/quality/lead\\_free.html](http://www.diodes.com/quality/lead_free.html) for more information about Diodes Incorporated's definitions of Halogen and Antimony free, "Green" and Lead-Free.
  3. Halogen and Antimony free "Green" products are defined as those which contain <900ppm bromine, <900ppm chlorine (<1500ppm total Br + Cl) and <1000ppm antimony compounds.
  4. For packaging details, go to our website at <http://www.diodes.com/products/packages.html>.

**Marking Information**

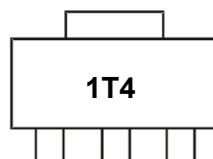

1T4 = Product Type Marking Code

**Absolute Maximum Ratings** (Voltage relative to GND, @T<sub>A</sub> = +25°C, unless otherwise specified.)

Characteristic	Symbol	Value	Unit
Input Supply Voltage	V <sub>IN</sub>	-0.3 to 100	V
Continuous Input & Output Current	I <sub>IN</sub> , I <sub>OUT</sub>	550	mA
Peak Pulsed Input & Output Current	I <sub>IM</sub> , I <sub>OM</sub>	2	A
Maximum Voltage applied to V <sub>OUT</sub>	V <sub>OUT(max)</sub>	18	V

**Maximum Current at V<sub>IN</sub> = 48V** (@T<sub>A</sub> = +25°C, unless otherwise specified.)

Characteristic	Symbol	Value	Unit
Continuous Output Current (Note 7)	I <sub>OUT</sub>	47	mA
Pulsed Output Current (Note 8)	I <sub>OM</sub>	880	mA
		180 (Note 9)	

**Thermal Characteristics**

Characteristic	Symbol	Value	Unit
Power Dissipation (Note 5)	P <sub>D</sub>	1.7	W
		0.89 (Note 6)	
Thermal Resistance, Junction to Ambient (Note 5)	R <sub>θJA</sub>	59	°C/W
		112 (Note 6)	
Thermal Resistance, Junction to Lead (Note 10)	R <sub>θJL</sub>	20	
Thermal Resistance, Junction to Case (Note 10)	R <sub>θJC</sub>	15.7	
Recommended Operating Junction Temperature Range	T <sub>J</sub>	-40 to +125	°C
Maximum Operating Junction and Storage Temperature Range	T <sub>J</sub> , T <sub>STG</sub>	-65 to +150	

**ESD Ratings** (Note 11)

Characteristics	Symbols	Value	Unit	JEDEC Class
Electrostatic Discharge – Human Body Model	ESD HBM	4000	V	3A
Electrostatic Discharge – Machine Model	ESD MM	400	V	C

- Notes:
- For a device mounted with the exposed V<sub>IN</sub> pad on 50mm x 50mm 1oz copper that is on a single-sided 1.6mm FR4 PCB; device is measured under still air conditions whilst operating in steady-state.
  - Same as note 5, except mounted on 15mm x 15mm 1oz copper.
  - Same as note 5, whilst operating at V<sub>IN</sub> = 48V. Refer to Safe Operating Area for other Input Voltages.
  - Same as note 5, except measured with a single pulse width = 100µs and V<sub>IN</sub> = 48V.
  - Same as note 5, except measured with a single pulse width = 10ms and V<sub>IN</sub> = 48V.
  - R<sub>θJL</sub> = Thermal resistance from junction to solder-point (on the exposed V<sub>IN</sub> pad).
  - R<sub>θJC</sub> = Thermal resistance from junction to the top of case.
  - Refer to JEDEC specification JESD22-A114 and JESD22-A115.

**Thermal Characteristics and Derating Information**

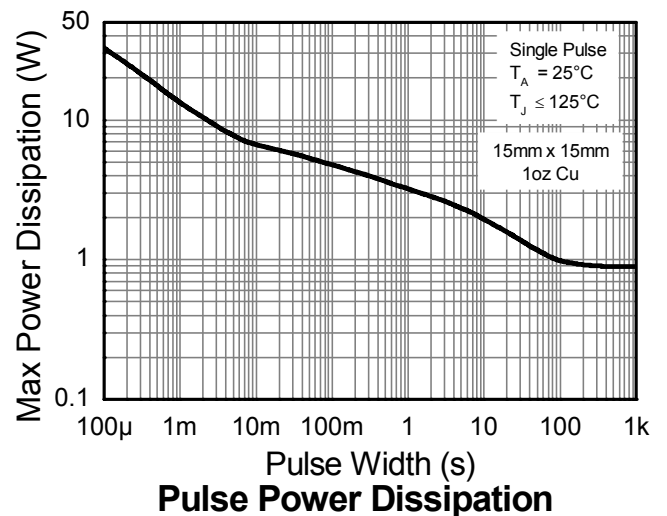
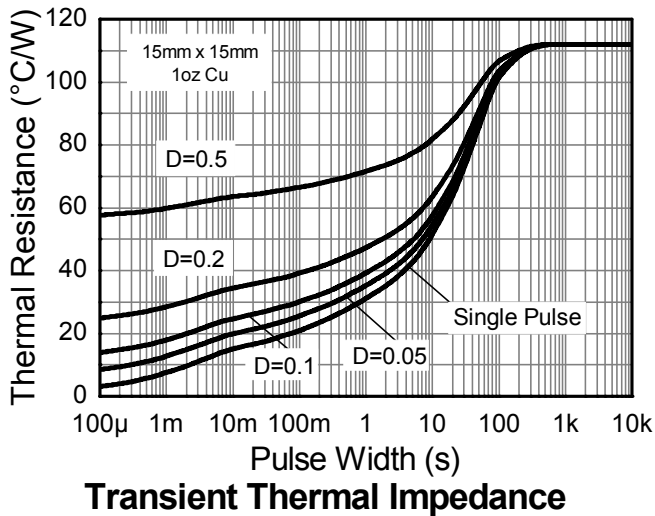
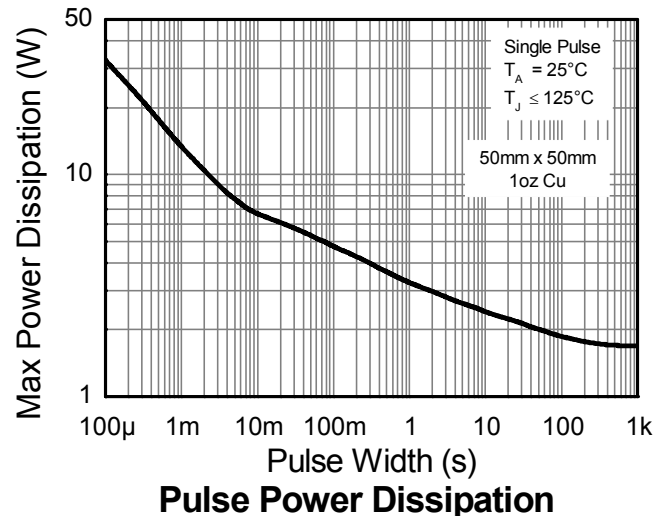
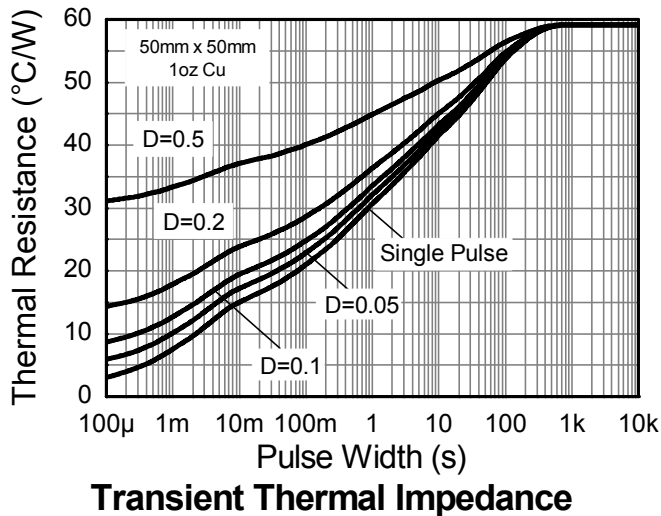
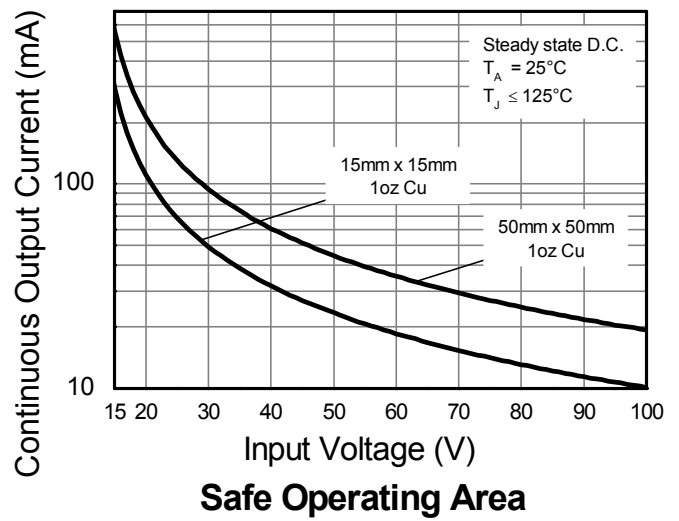
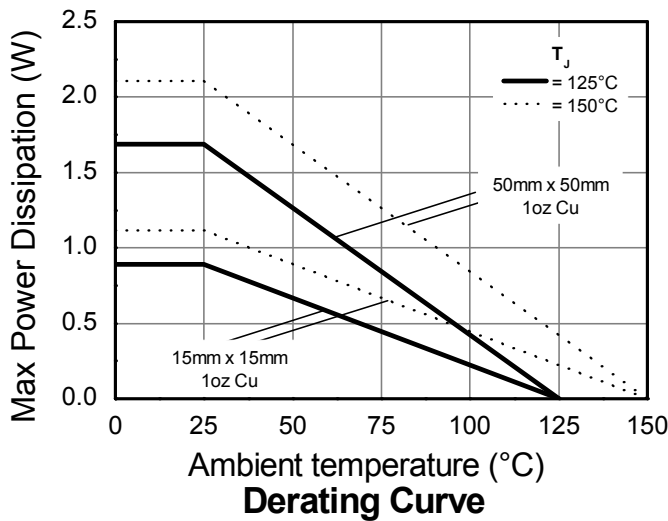

**Electrical Characteristics** (@T<sub>A</sub> = +25°C, unless otherwise specified.)

Characteristic	Symbol	Min	Typ	Max	Unit	Test Condition
Output Voltage (Note 12)	V <sub>OUT</sub>	10.8	12	13.2	V	V <sub>IN</sub> = 48V, I <sub>OUT</sub> = 15mA
Line Regulation (Notes 12 & 13)	ΔV <sub>OUT</sub>	—	240	750	mV	V <sub>IN</sub> = 15 to 72V, I <sub>OUT</sub> = 15mA
Temperature Coefficient	ΔV <sub>OUT</sub> /ΔT	—	8.0	—	mV/°C	T <sub>J</sub> = -40°C to +125°C V <sub>IN</sub> = 48V, I <sub>OUT</sub> = 15mA
Load Regulation (Notes 12 & 14)	ΔV <sub>OUT</sub>	—	-450 -600	-600 -750	mV	I <sub>OUT</sub> = 0.1 to 30mA, V <sub>IN</sub> = 48V I <sub>OUT</sub> = 0.1 to 100mA, V <sub>IN</sub> = 48V
Minimum Value of Input Voltage Required to Maintain Line Regulation	V <sub>IN(MIN)</sub>	15	—	—	V	—
Quiescent Current	I <sub>Q</sub>	—	240 590	400 900	μA	V <sub>IN</sub> = 48V, I <sub>OUT</sub> = 10μA V <sub>IN</sub> = 100V, I <sub>OUT</sub> = 10μA
Power Supply Rejection Ratio	ΔV <sub>IN</sub> /ΔV <sub>OUT</sub>	—	45	—	dB	C <sub>OUT</sub> = 100nF, I <sub>OUT</sub> = 15mA, V <sub>OUT</sub> = 12V, V <sub>IN</sub> = 15 to 100V, f=100Hz

- Notes:
- 12. Measured under pulsed conditions. Pulse width ≤ 300μs. Duty cycle ≤ 2%.
  - 13. Line regulation ΔV<sub>OUT</sub> = V<sub>OUT</sub>(@ V<sub>IN</sub> = 72V) – V<sub>OUT</sub>(@ V<sub>IN</sub> = 15V)
  - 14. Load regulation ΔV<sub>OUT</sub> = V<sub>OUT</sub>(@ I<sub>OUT</sub> = 30mA) – V<sub>OUT</sub>(@ I<sub>OUT</sub> = 0.1mA)  
ΔV<sub>OUT</sub> = V<sub>OUT</sub>(@ I<sub>OUT</sub> = 100mA) – V<sub>OUT</sub>(@ I<sub>OUT</sub> = 0.1mA)

**Typical Application Circuit**

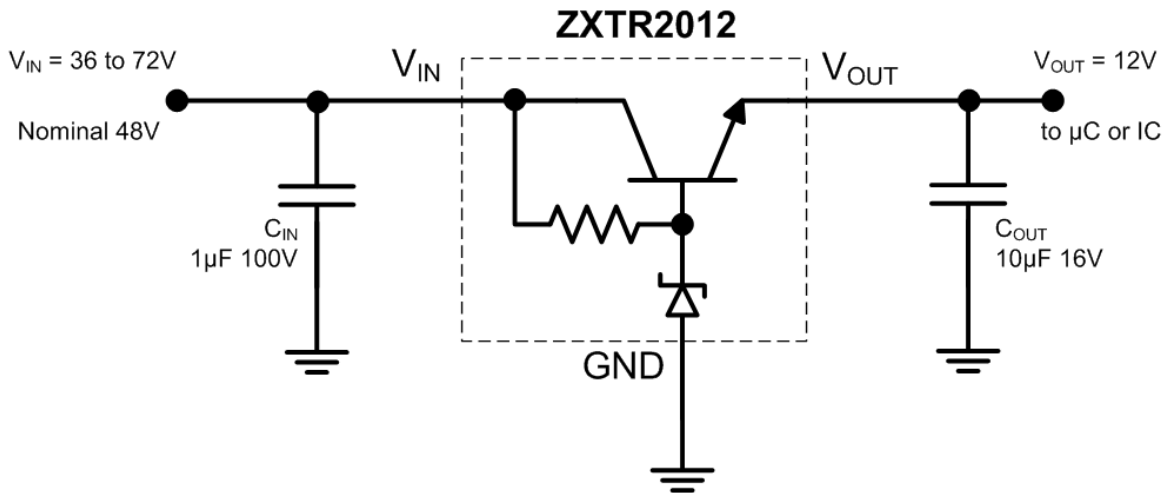

Example of an 12V regulated supply from a nominal 48V for powering a Controller IC.

**Pin Functions**

Pin Name	Pin Function	Notes
V <sub>IN</sub>	Input Supply	To maintain output regulation the input voltage can vary from 15V to 100V with respect to the GND pin. It is recommended to connect a 1μF capacitor to GND.
GND	Power Ground	This pin should be tied to the system ground.
V <sub>OUT</sub>	Voltage Output	Outputs a regulated 12V. It is recommended to connect a 10μF capacitor to GND. Minimum of 10μA must be drawn from V <sub>OUT</sub> to maintain regulation. The pin can be pulled high to a maximum of 18V with respect to ground.

**Typical Electrical Characteristics** (@ $T_A = +25^\circ\text{C}$ , unless otherwise specified.)

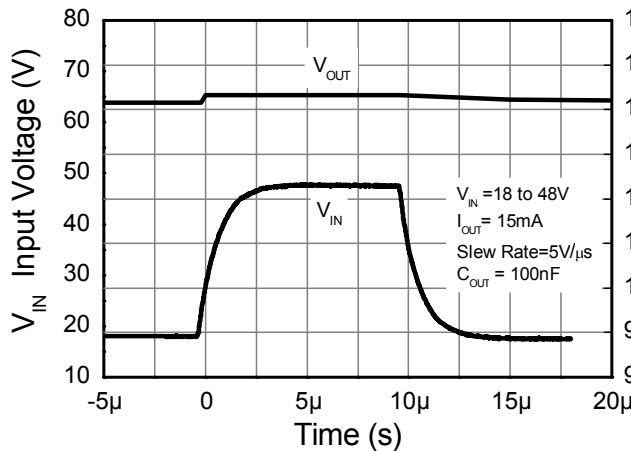

**Line transient response**

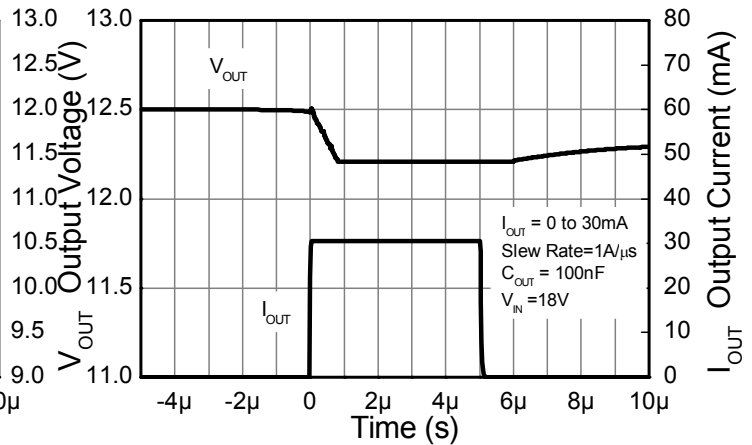

**Load transient response**

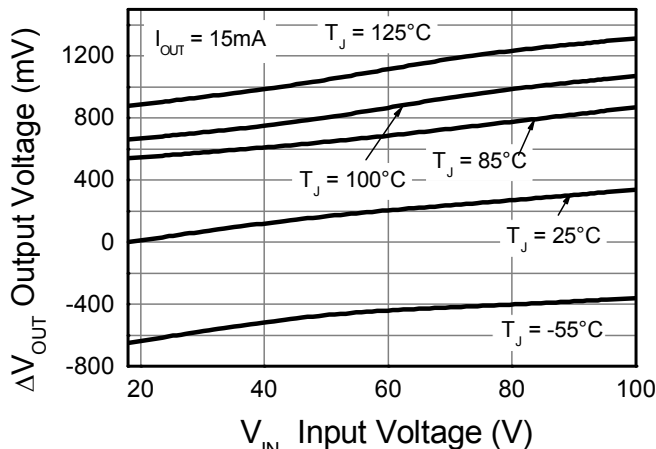

**Line Regulation (Note 15)**

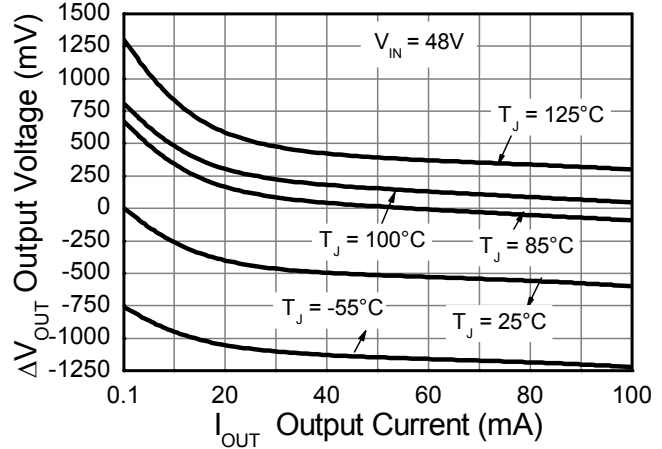

**Load Regulation (Note 16)**

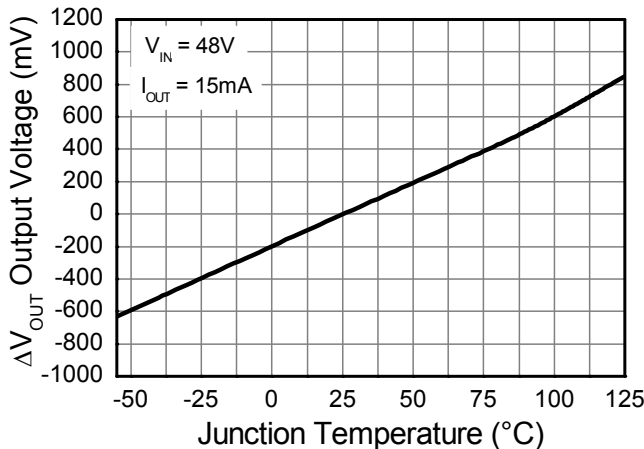

**Temperature Coefficient (Note 17)**

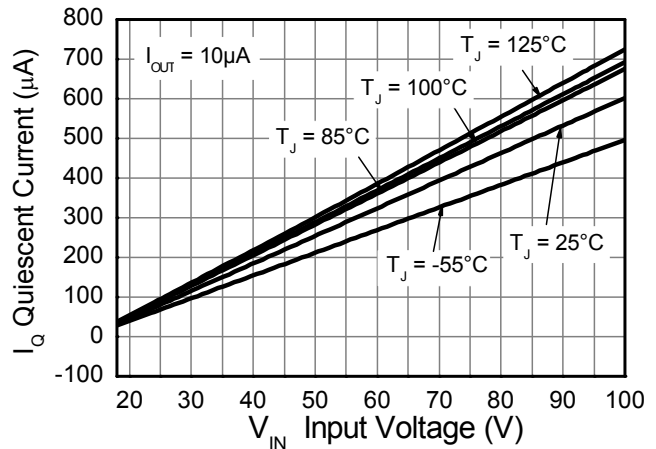

**Quiescent Current**

- Notes:
- 15. Line regulation  $\Delta V_{OUT} = V_{OUT} - V_{OUT}(@ V_{IN} = 15\text{V}, I_{OUT} = 15\text{mA}, T_J = +25^\circ\text{C})$
  - 16. Load regulation  $\Delta V_{OUT} = V_{OUT} - V_{OUT}(@ V_{IN} = 48\text{V}, I_{OUT} = 0.1\text{mA}, T_J = +25^\circ\text{C})$
  - 17. Temperature Coefficient  $\Delta V_{OUT} = V_{OUT} - V_{OUT}(@ V_{IN} = 48\text{V}, I_{OUT} = 15\text{mA}, T_J = +25^\circ\text{C})$

## Package Outline Dimensions

Please see AP02002 at <http://www.diodes.com/datasheets/ap02002.pdf> for latest version.

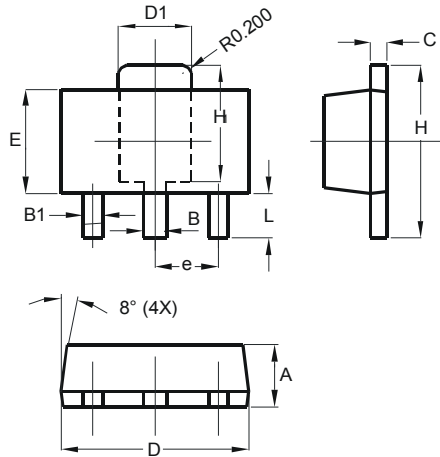

SOT89		
Dim	Min	Max
A	1.40	1.60
B	0.44	0.62
B1	0.35	0.54
C	0.35	0.44
D	4.40	4.60
D1	1.62	1.83
E	2.29	2.60
e	1.50 Typ	
H	3.94	4.25
H1	2.63	2.93
L	0.89	1.20
All Dimensions in mm		

## Suggested Pad Layout

Please see AP02001 at <http://www.diodes.com/datasheets/ap02001.pdf> for the latest version.

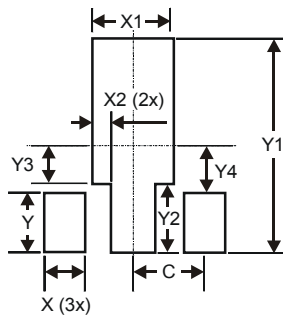

Dimensions	Value (in mm)
X	0.900
X1	1.733
X2	0.416
Y	1.300
Y1	4.600
Y2	1.475
Y3	0.950
Y4	1.125
C	1.500

**IMPORTANT NOTICE**

DIODES INCORPORATED MAKES NO WARRANTY OF ANY KIND, EXPRESS OR IMPLIED, WITH REGARDS TO THIS DOCUMENT, INCLUDING, BUT NOT LIMITED TO, THE IMPLIED WARRANTIES OF MERCHANTABILITY AND FITNESS FOR A PARTICULAR PURPOSE (AND THEIR EQUIVALENTS UNDER THE LAWS OF ANY JURISDICTION).

Diodes Incorporated and its subsidiaries reserve the right to make modifications, enhancements, improvements, corrections or other changes without further notice to this document and any product described herein. Diodes Incorporated does not assume any liability arising out of the application or use of this document or any product described herein; neither does Diodes Incorporated convey any license under its patent or trademark rights, nor the rights of others. Any Customer or user of this document or products described herein in such applications shall assume all risks of such use and will agree to hold Diodes Incorporated and all the companies whose products are represented on Diodes Incorporated website, harmless against all damages.

Diodes Incorporated does not warrant or accept any liability whatsoever in respect of any products purchased through unauthorized sales channel. Should Customers purchase or use Diodes Incorporated products for any unintended or unauthorized application, Customers shall indemnify and hold Diodes Incorporated and its representatives harmless against all claims, damages, expenses, and attorney fees arising out of, directly or indirectly, any claim of personal injury or death associated with such unintended or unauthorized application.

Products described herein may be covered by one or more United States, international or foreign patents pending. Product names and markings noted herein may also be covered by one or more United States, international or foreign trademarks.

This document is written in English but may be translated into multiple languages for reference. Only the English version of this document is the final and determinative format released by Diodes Incorporated.

**LIFE SUPPORT**

Diodes Incorporated products are specifically not authorized for use as critical components in life support devices or systems without the express written approval of the Chief Executive Officer of Diodes Incorporated. As used herein:

A. Life support devices or systems are devices or systems which:

1. are intended to implant into the body, or
2. support or sustain life and whose failure to perform when properly used in accordance with instructions for use provided in the labeling can be reasonably expected to result in significant injury to the user.

B. A critical component is any component in a life support device or system whose failure to perform can be reasonably expected to cause the failure of the life support device or to affect its safety or effectiveness.

Customers represent that they have all necessary expertise in the safety and regulatory ramifications of their life support devices or systems, and acknowledge and agree that they are solely responsible for all legal, regulatory and safety-related requirements concerning their products and any use of Diodes Incorporated products in such safety-critical, life support devices or systems, notwithstanding any devices- or systems-related information or support that may be provided by Diodes Incorporated. Further, Customers must fully indemnify Diodes Incorporated and its representatives against any damages arising out of the use of Diodes Incorporated products in such safety-critical, life support devices or systems.

Copyright © 2013, Diodes Incorporated

[www.diodes.com](http://www.diodes.com)