



## Glass Passivated Three Phase Bridge Rectifiers

**VRRM** 600 to 1600V

**IFAV** 35 Amp

### Features

- High thermal conductivity package, electrically insulated case
- Centre hole fixing
- Glass passivated chips
- High IFSM
- Epoxy compound has classification UL94V-0

### Applications

- Big power supplier
- Field supply for DC motor

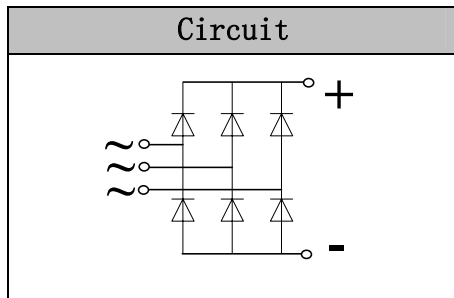

### Module Type

TYPE	VRRM	VRSM
MT3506A	600V	700V
MT3508A	800V	900V
MT3510A	1000V	1100V
MT3512A	1200V	1300V
MT3514A	1400V	1500V
MT3516A	1600V	1700V

### Maximum Ratings

Symbol	Item	Conditions	Values	Units
IO	Average forward output current	Tc=78°C	35	A
IFSM	Forward surge current, max.	t=8.3ms Single Half-Sine-Wave Superimposed On Rated Load (JEDEC METHOD)	450	A
i <sup>2</sup> t	Value for fusing	t=8.3mS VR=0	840	A <sup>2</sup> s
Visol	Isolation Breakdown Voltage(R.M.S)	a.c.50HZ;r.m.s.;1min Tj=25°C	2500	V
Tvj	Operating Junction Temperature		-55 to +150	°C
Tstg	Storage Temperature		-55 to +150	°C
Mt	Mounting Torque		2	N.m
Weight	Bridge(Approximately)		21	g

### Thermal Characteristics

Symbol	Item	Conditions	Values	Units
Rth(j-c)	Junction to Case	Bridge	0.9	°C/W

### Electrical Characteristics

Symbol	Item	Conditions	Values			Units
			Min.	Typ.	Max.	
VFM	Forward Voltage Drop, max.	T=25°C IF =17.5A	—	1.00	1.20	V
IRD	Maximum DC Reverse	Tvj =25°C VRD=VRRM Tvj =150°C VRD=VRRM	—	—	5.0 2.0	uA mA

## Characteristic Curve

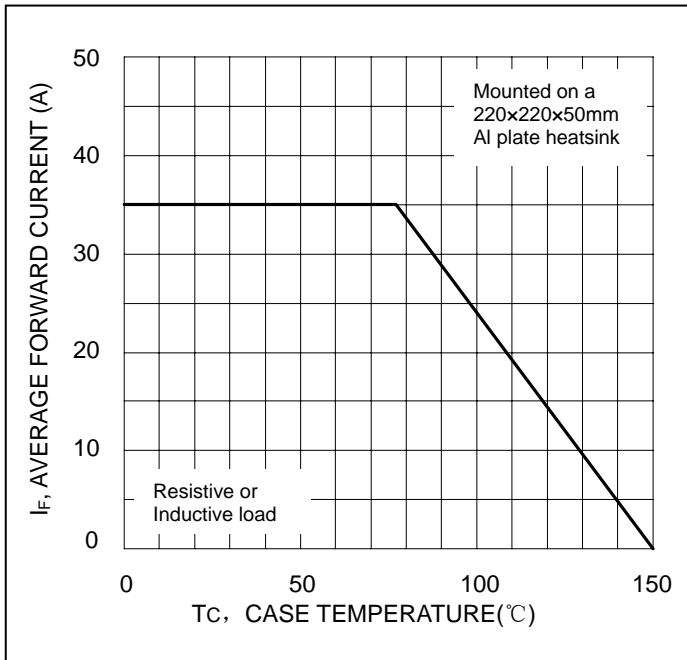

Fig. 1 Forward Current Derating Curve

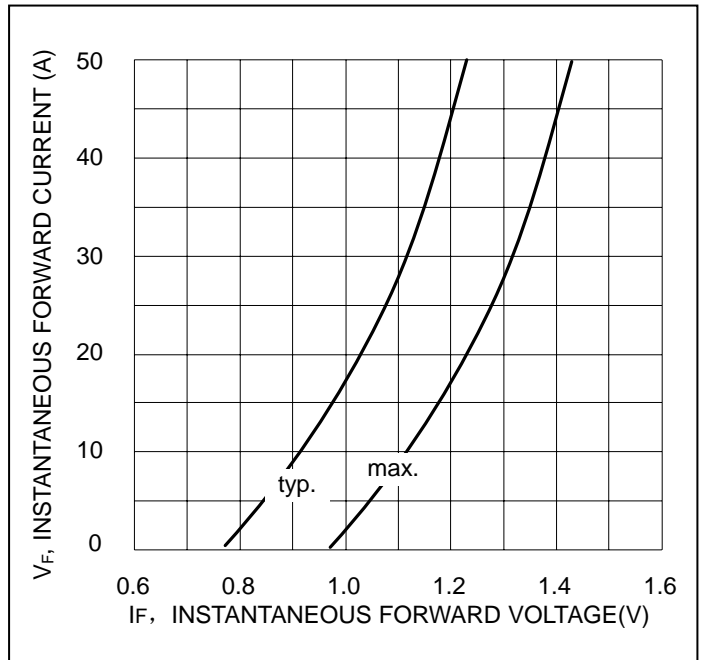

Fig. 2 Typical Forward Characteristics

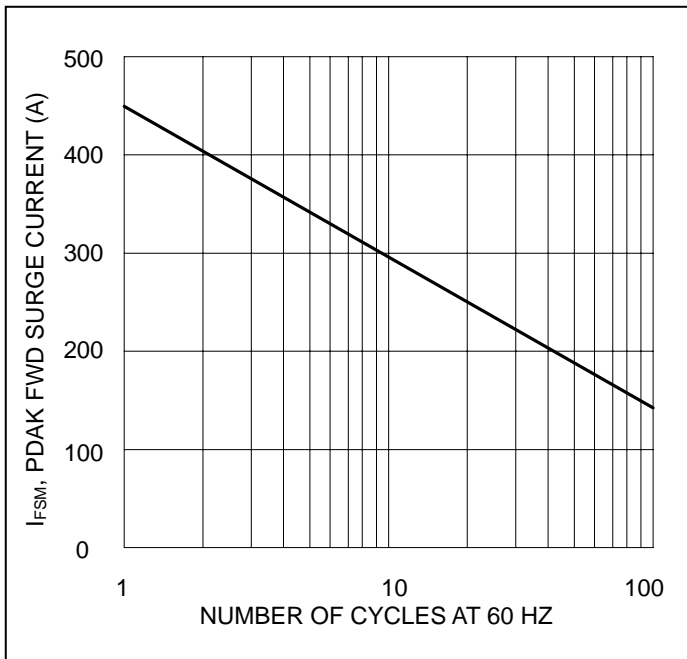

Fig. 3 Max Non-Repetitive Peak Surge Current

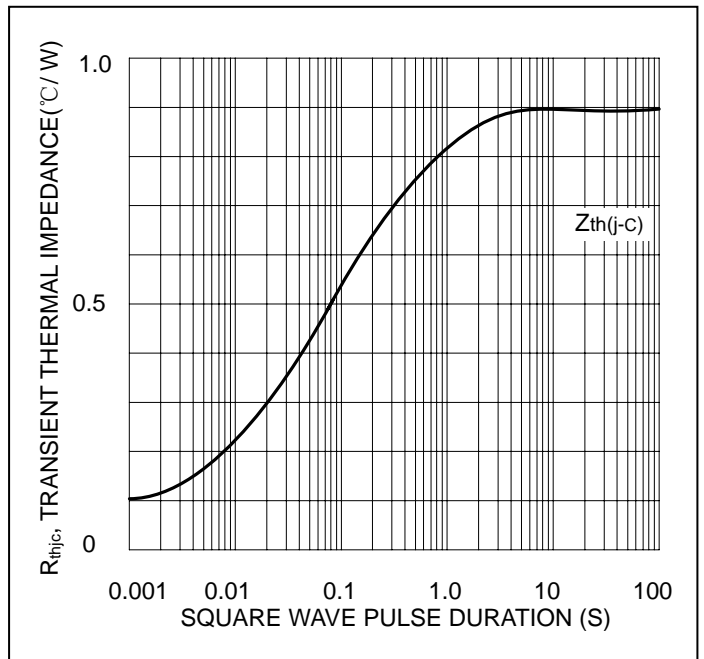
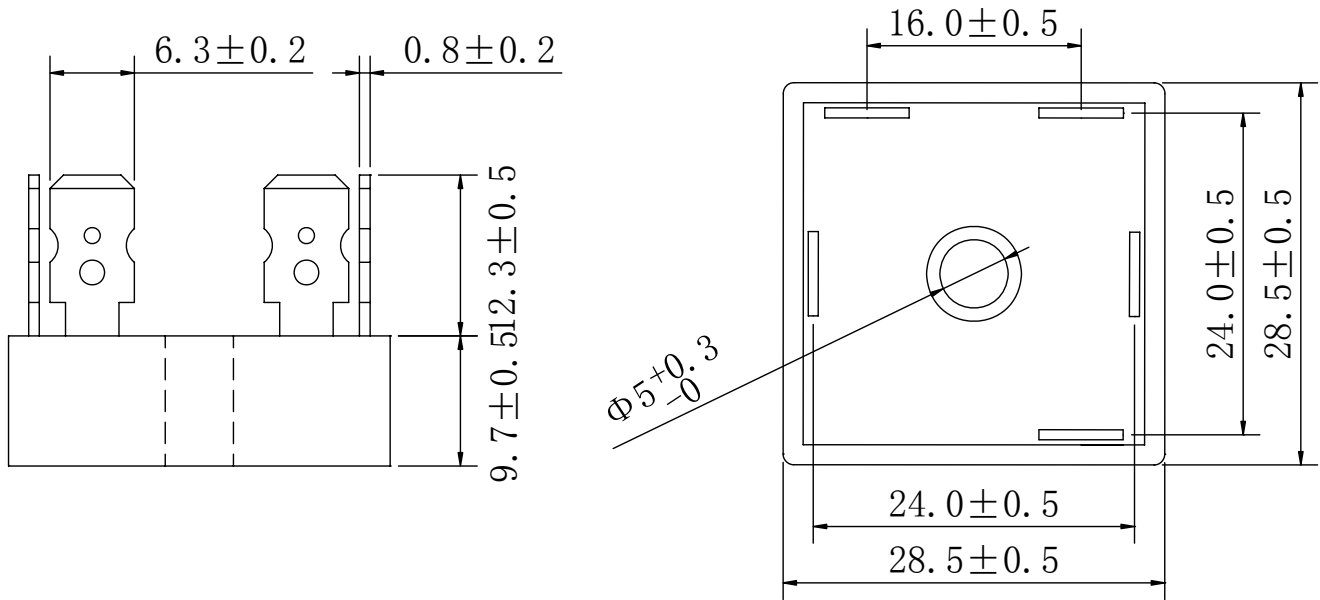

Fig. 4. Transient thermal impedance

## Package Outline Information

CASE: MT-A



Dimensions in mm