

PNP Transistors

2SB1215

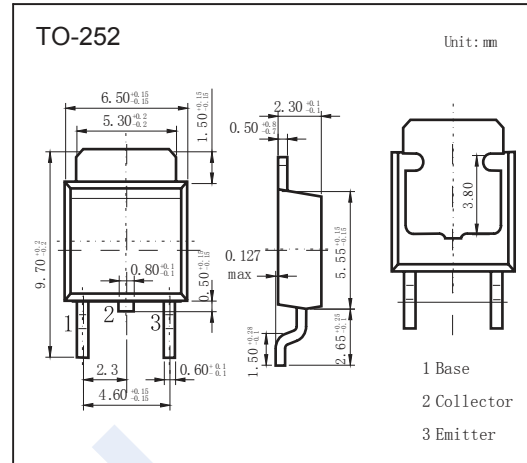

■ Features

- Low collector-to-emitter saturation voltage.
- High current and high fr
- Fast switching time.
- Complementary to 2SD1815

■ Absolute Maximum Ratings $T_a = 25^\circ\text{C}$

Parameter	Symbol	Rating	Unit
Collector - Base Voltage	V_{CB0}	-120	V
Collector - Emitter Voltage	V_{CE0}	-100	
Emitter - Base Voltage	V_{EB0}	-6	
Collector Current - Continuous	I_C	-3	A
Collector Current - Pulse	I_{CP}	-6	
Collector Power Dissipation $T_c = 25^\circ\text{C}$	P_C	20	W
		1	
Junction Temperature	T_J	150	$^\circ\text{C}$
Storage Temperature range	T_{stg}	-55 to 150	

■ Electrical Characteristics $T_a = 25^\circ\text{C}$

Parameter	Symbol	Test Conditions	Min	Typ	Max	Unit
Collector- base breakdown voltage	V_{CB0}	$I_C = -100 \mu\text{A}$, $I_E = 0$	-120			V
Collector- emitter breakdown voltage	V_{CE0}	$I_C = -1 \text{ mA}$, $R_{BE} = \infty$	-100			
Emitter - base breakdown voltage	V_{EB0}	$I_E = -100 \mu\text{A}$, $I_C = 0$	-6			
Collector-base cut-off current	I_{CBO}	$V_{CB} = -100\text{V}$, $I_E = 0$			-1	μA
Emitter cut-off current	I_{EBO}	$V_{EB} = -5\text{V}$, $I_C = 0$			-1	
Collector-emitter saturation voltage	$V_{CE(sat)}$	$I_C = -1.5 \text{ A}$, $I_B = -150\text{mA}$		-0.2	-0.5	V
Base - emitter saturation voltage	$V_{BE(sat)}$	$I_C = -1.5 \text{ A}$, $I_B = -150\text{mA}$		-0.9	-1.2	
DC current gain	h_{FE}	$V_{CE} = -5\text{V}$, $I_C = -500 \text{ mA}$	70		400	
		$V_{CE} = -5\text{V}$, $I_C = -2 \text{ A}$	40			
Turn-ON Time	t_{on}	See specified Test Circuit		100		ns
Storage Time	t_{stg}			800		
Fall Time	t_f			50		
Collector output capacitance	C_{ob}	$V_{CB} = -10\text{V}$, $I_E = 0$, $f = 1\text{MHz}$		40		pF
Transition frequency	f_T	$V_{CE} = -10\text{V}$, $I_C = -500 \text{ mA}$		130		MHz

■ Classification of $h_{fe}(1)$

Type	2SB1215-Q	2SB1215-R	2SB1215-S	2SB1215-T
Range	70-140	100-200	140-280	200-400

PNP Transistors

2SB1215

Switching Time Test Circuit

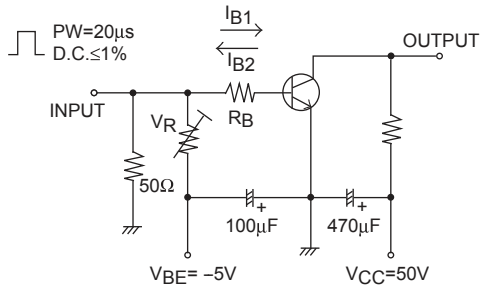

$I_C = 10I_{B1} = -10I_{B2} = 1.5A$
 For PNP, the polarity is reversed.

■ Typical Characteristics

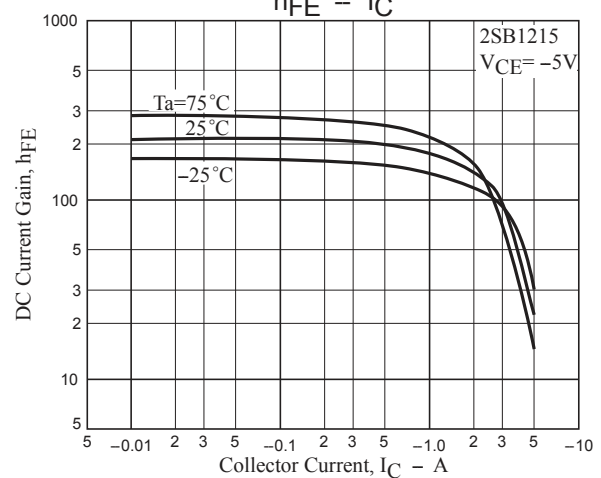
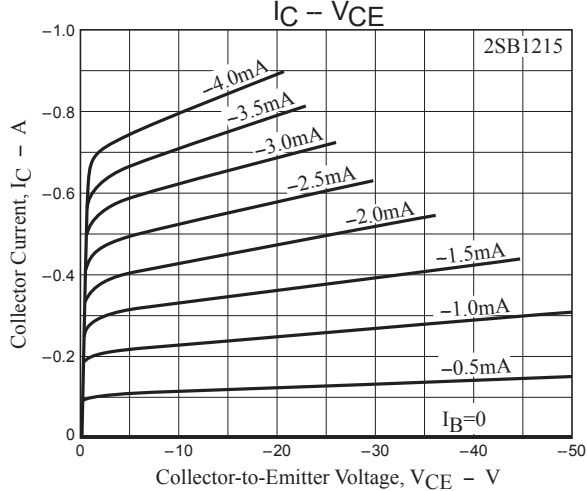
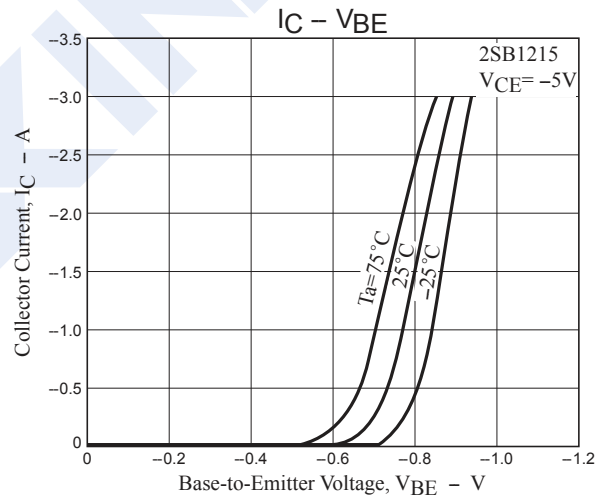
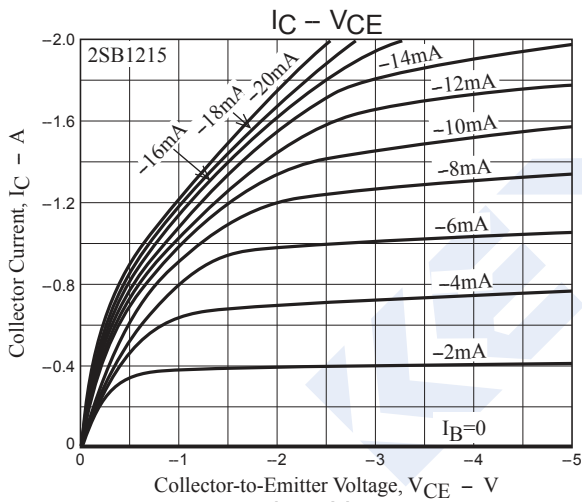

PNP Transistors

2SB1215

Typical Characteristics

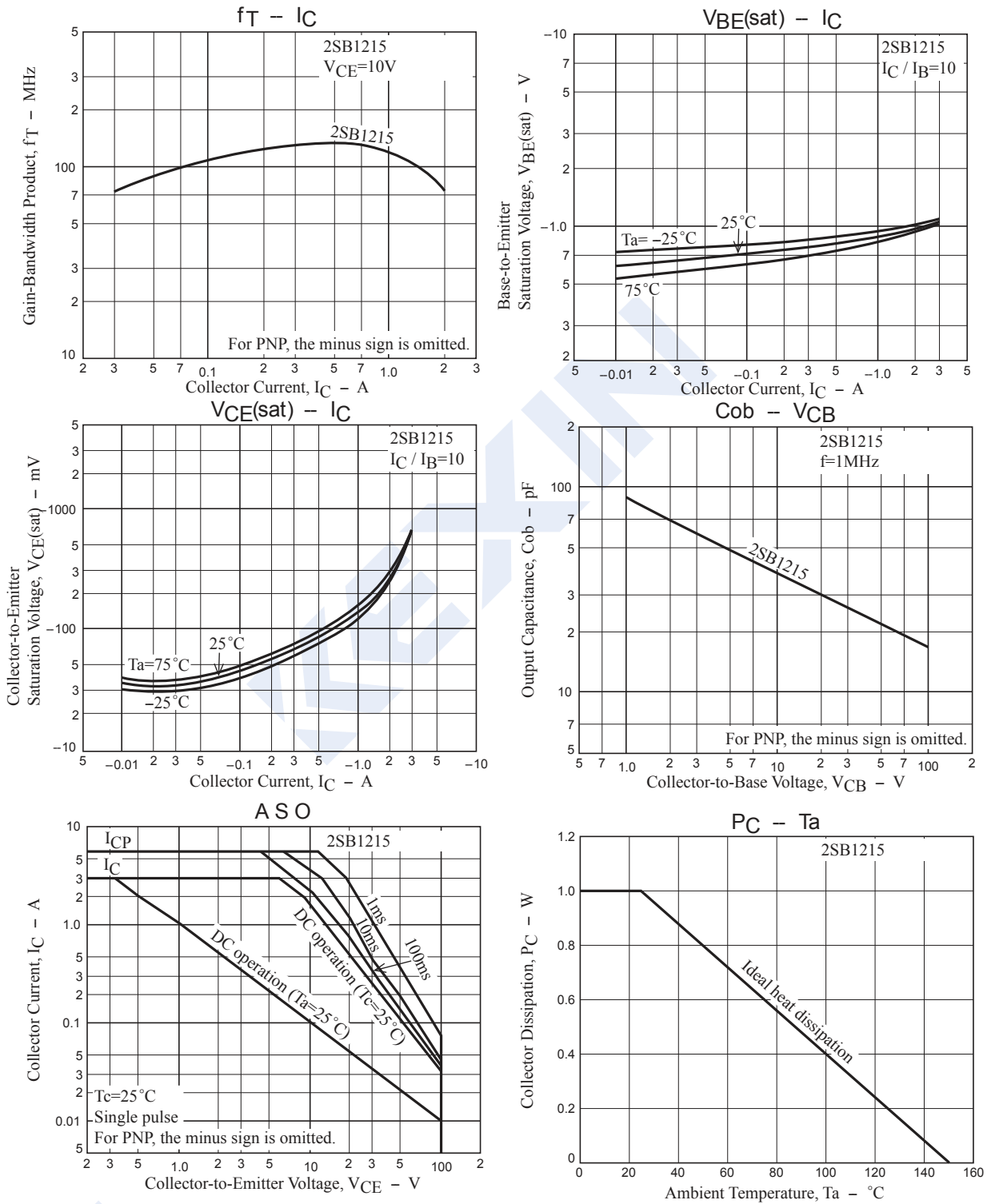

PNP Transistors

2SB1215

■ Typical Characteristics

