

Switching Diode

FEATURES

Two elements

Small Package

Environmentally Friendly : EU RoHS Compliant, Pb Free

PRODUCT NAME

PRODUCT NAME	PACKAGE	ORDER UNIT
XBW21P0204-G *	SOT-323	3,000/Reel

* The "-G" suffix denotes Halogen and Antimony free as well as being fully EU RoHS compliant.

PIN CONFIGURATION

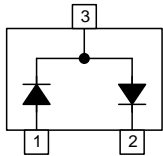

ABSOLUTE MAXIMUM RATINGS

Ta=25°C

PARAMETER	SYMBOL	RATINGS	UNIT
Reverse Voltage (DC)	V_R	75	V
Peak Reverse Voltage	V_{RM}	100	V
Forward Current (Average)	$I_{F(AV)}$	150	mA
Peak Forward Surge Current (t=1 μ s)	I_{FSM}	4	A
Power Dissipation	P_d	200	mW
Junction Temperature	T_j	150	°C
Storage Temperature	T_{stg}	-55 to +150	°C

ELECTRICAL CHARACTERISTICS

Ta=25°C

PARAMETER	SYMBOL	TEST CONDITIONS	LIMITS			UNITS
			MIN.	TYP.	MAX.	
Forward Voltage	V_{F1}	$I_F=10mA$	-	-	0.855	V
	V_{F2}	$I_F=50mA$	-	-	1.00	V
	V_{F3}	$I_F=150mA$	-	-	1.25	V
Reverse Current	I_R	$V_R=25V$	-	-	0.03	μ A
Terminal Capacitance	C_t	$V_R=0V, f=1MHz$	-	-	1.5	pF
Reverse Recovery Time	t_{rr}	$I_F=I_R=10mA, i_{rr}=1mA, R_L=100\Omega$	-	4	-	ns

APPLICATIONS

- High-speed Switching

PACKAGING INFORMATION

- SOT-323

Unit : inch (mm)

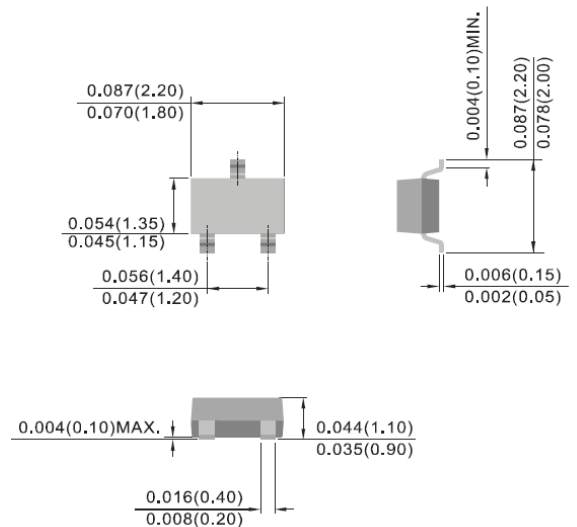

MEASUREMENT CIRCUITS

Reverse Recovery Time

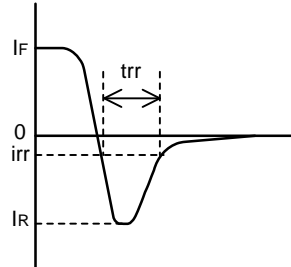
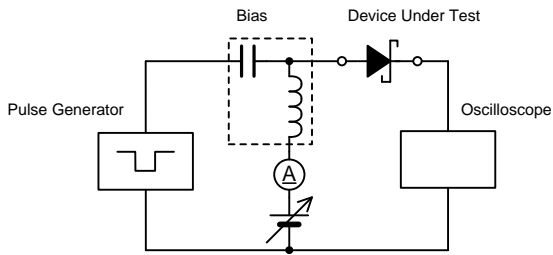

NOTES ON USE

1. Please use this IC within the absolute maximum ratings.

Even within the ratings, in case of high load use continuously such as high temperature, high voltage, high current and thermal stress may cause reliability degradation of the IC.

2. Torex places an importance on improving our products and their reliability.

We request that users incorporate fail-safe designs and post-aging protection treatment when using Torex products in their systems.

■ TYPICAL PERFORMANCE CHARACTERISTICS

(1) Forward Current vs. Forward Voltage

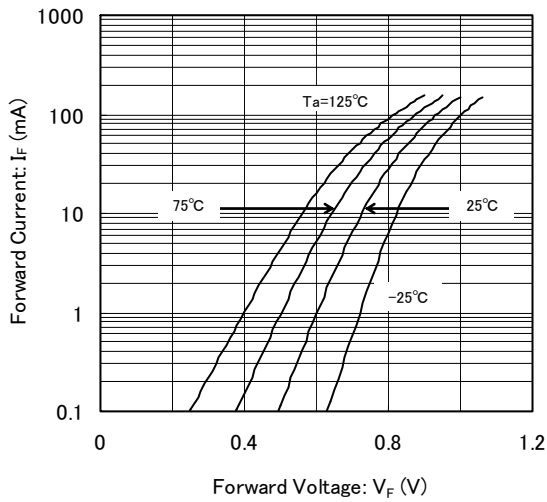

(2) Reverse Current vs. Reverse Voltage

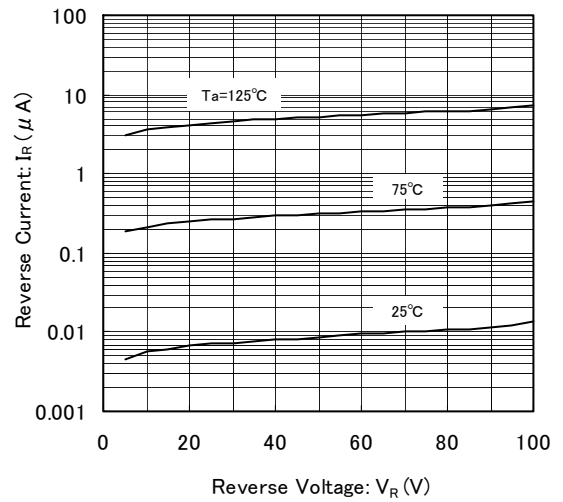

(3) Terminal Capacitance vs. Reverse Voltage

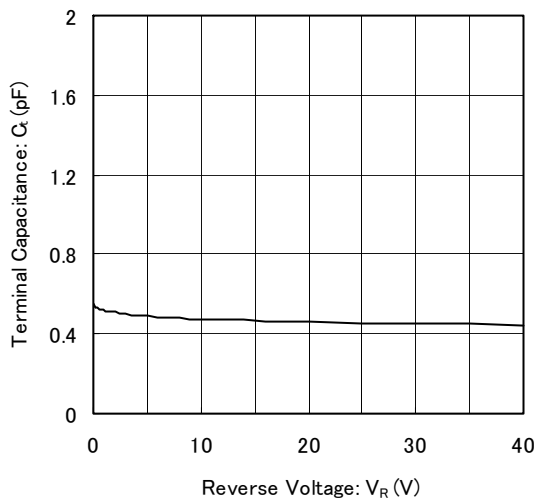

(4) Power Dissipation vs. Operating Temperature

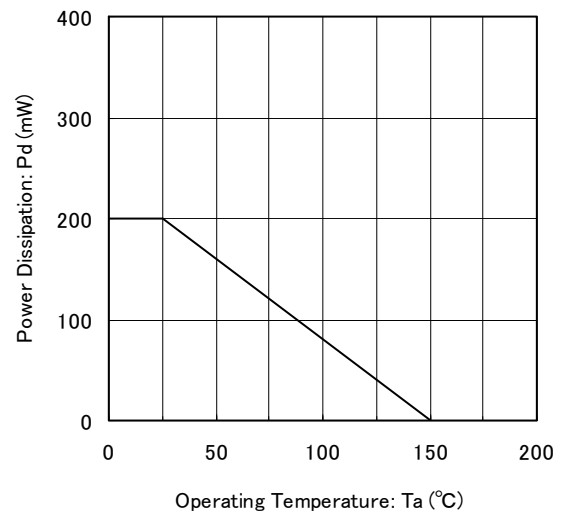

REFERENCE PATTERN LAYOUT

●SOT-323

Unit : inch (mm)

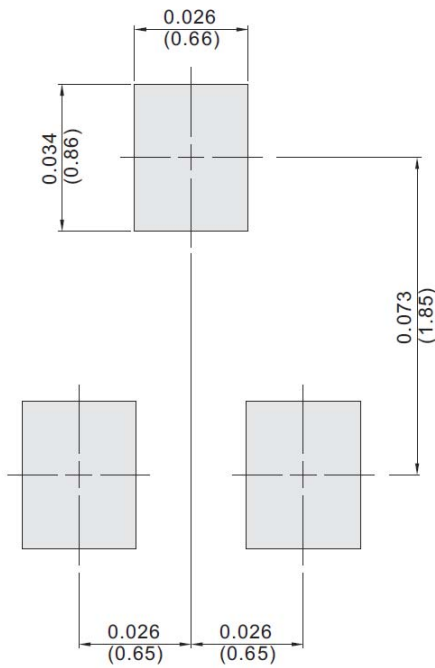

MARKING

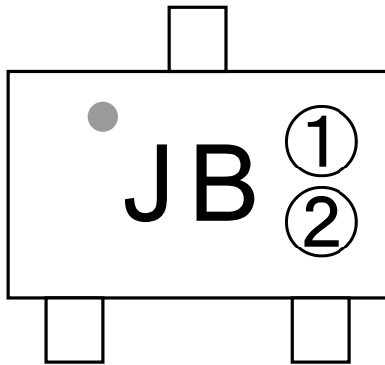

①② : Control Number

TAPING SPECIFICATIONS

●SOT-323

Unit : mm

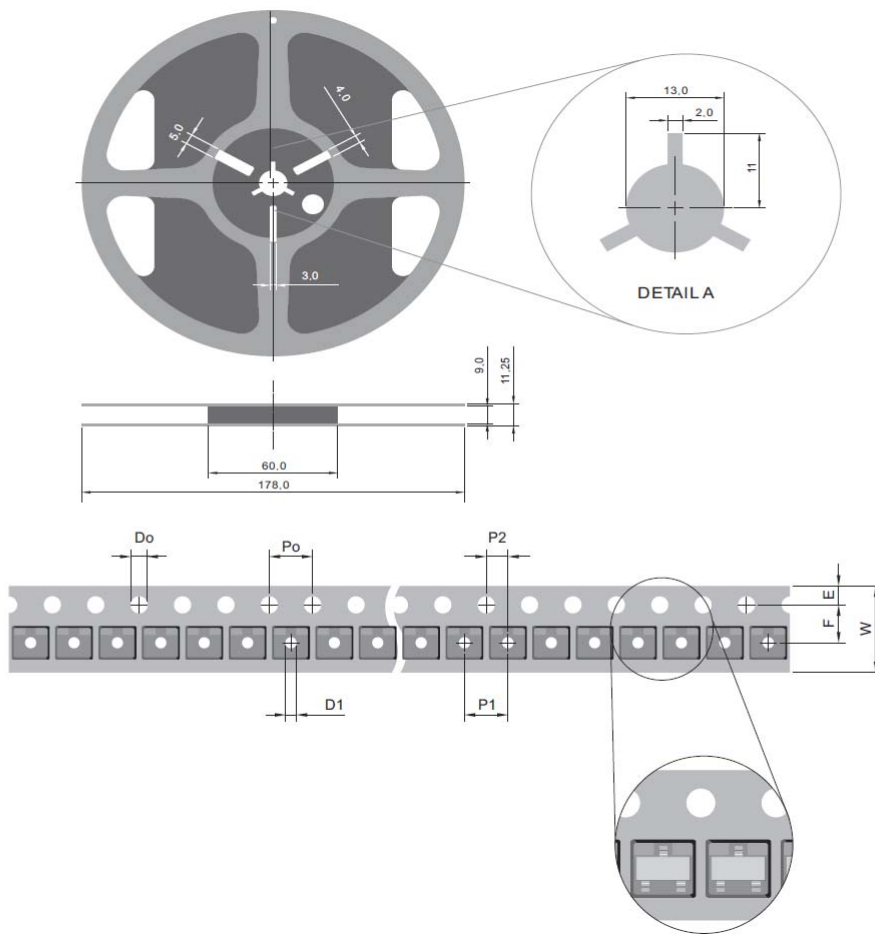

SYMBOL	mm
D_0	1.55 ± 0.05
D_1	1.00 ± 0.25
E	1.75 ± 0.10
F	3.50 ± 0.05
P_0	4.00 ± 0.10
P_1	4.00 ± 0.10
P_2	2.00 ± 0.05
W	$8.00 \begin{matrix} + 0.3 \\ - 0.15 \end{matrix}$

1. The products and product specifications contained herein are subject to change without notice to improve performance characteristics. Consult us, or our representatives before use, to confirm that the information in this datasheet is up to date.
2. We assume no responsibility for any infringement of patents, patent rights, or other rights arising from the use of any information and circuitry in this datasheet.
3. Please ensure suitable shipping controls (including fail-safe designs and aging protection) are in force for equipment employing products listed in this datasheet.
4. The products in this datasheet are not developed, designed, or approved for use with such equipment whose failure or malfunction can be reasonably expected to directly endanger the life of, or cause significant injury to, the user.
(e.g. Atomic energy; aerospace; transport; combustion and associated safety equipment thereof.)
5. Please use the products listed in this datasheet within the specified ranges.
Should you wish to use the products under conditions exceeding the specifications, please consult us or our representatives.
6. We assume no responsibility for damage or loss due to abnormal use.
7. All rights reserved. No part of this datasheet may be copied or reproduced without the prior permission of TOREX SEMICONDUCTOR LTD.

TOREX SEMICONDUCTOR LTD.