



STMPS2242, STMPS2252 STMPS2262, STMPS2272

Enhanced dual-channel power switches

Features

- 100 mΩ high-side MOSFET switch
- 500 mA/1000 mA continuous current per channel
- Thermal protection
- Independent short-circuit protection with overcurrent logic output
- Operating range from 2.7 V to 5.5 V
- CMOS and TTL compatible inputs
- 2.5 ms typical rise time
- Undervoltage lockout
- 13 μA maximum standby supply current
- Ambient temperature range: -40 °C to 85 °C
- 8 kV ESD protection
- Reverse current protection
- Fault blanking

Description

The STMPS2242/2252/2262/2272 power distribution switches are intended for applications where heavy capacitive loads and short-circuits are likely to be encountered. These devices incorporate 100 mΩ MOSFET high-side power switches for power distribution systems that require multiple power switches in a single package.

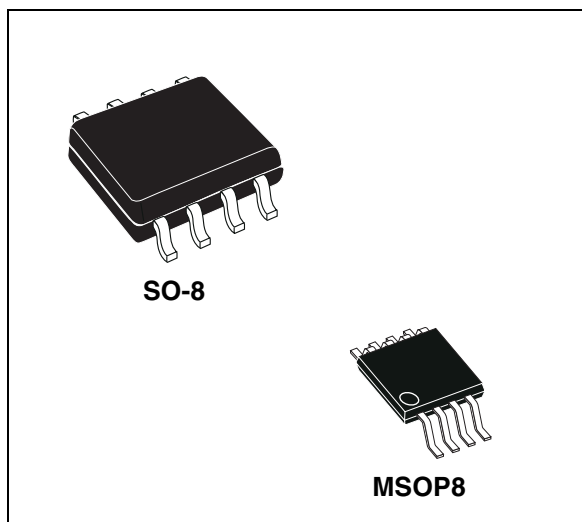

Each switch is controlled by an independent logic enable input. When the output load exceeds the current limit threshold or a short is present, these devices limit the output current to a safe level by switching into a constant current mode, pulling the overcurrent (OCx) logic output low. When continuous heavy overloads and short-circuits increase the power dissipation in the switch, causing the junction temperature to rise, a thermal protection circuit shuts off the switch to prevent damage. Recovery from a thermal shutdown is automatic once the device has cooled sufficiently. Internal circuitry ensures the switch remains off until valid input voltage is present.

Table 1. Device summary

Order code		Current limit (mA)	Enable	Packing
SO-8	MSOP8 ⁽¹⁾			
STMPS2242MTR	STMPS2242TTR	500	Active low	Tape and reel
STMPS2252MTR	STMPS2252TTR	500	Active high	Tape and reel
STMPS2262MTR	STMPS2262TTR	1000	Active low	Tape and reel
STMPS2272MTR	STMPS2272TTR	1000	Active high	Tape and reel

1. MSOP8 is also known as TSSOP8.

Contents

1	Block diagram	6
2	Pin descriptions	7
3	Functional description	8
3.1	Fault blanking	8
3.2	Overcurrent/overtemperature protection	8
3.3	Reverse current blocking	8
3.4	UVLO	8
4	Maximum rating	9
4.1	Absolute maximum rating	9
4.2	Recommended operating conditions	9
5	Electrical specifications	10
6	Typical operating characteristics	13
6.1	STMPS2242, STMPS2252 characteristics	13
6.1.1	Turn-on/off characteristics for $V_I = 3\text{ V}$, $R_{LOAD} = 6\ \Omega$	13
6.1.2	Turn-on/off characteristics for $V_I = 5\text{ V}$, $R_{LOAD} = 10\ \Omega$	16
6.1.3	UVLO characteristics	20
6.1.4	Overcurrent protection characteristics	21
6.1.5	Other electrical characteristics	22
6.2	STMPS2262, STMPS2272 characteristics	24
6.2.1	Turn-on/off characteristics for $V_I = 3\text{ V}$, $R_{LOAD} = 3\ \Omega$	24
6.2.2	Turn-on/off characteristics for $V_I = 5\text{ V}$, $R_{LOAD} = 5\ \Omega$	27
6.2.3	UVLO characteristics	30
6.2.4	Overcurrent protection characteristics	32
6.2.5	Other electrical characteristics	33
7	Application information	35
7.1	Input and output capacitors	35
8	Package mechanical data	36

9 **Revision history** **41**

List of tables

Table 1.	Device summary	1
Table 2.	Pin descriptions	7
Table 3.	Absolute maximum ratings	9
Table 4.	Recommended operating conditions	9
Table 5.	Electrical characteristics	10
Table 6.	Current limit characteristics ($V_I = 5.5\text{ V}$, $I_O = \text{rated current}$, $T_J = 25^\circ\text{C}$, unless otherwise specified)	10
Table 7.	Supply current characteristics ($V_I = 5.5\text{ V}$, $I_O = \text{rated current}$, $T_J = 25^\circ\text{C}$, unless otherwise specified)	11
Table 8.	Thermal characteristics ($V_I = 5.5\text{ V}$, $I_O = \text{rated current}$, $T_J = 25^\circ\text{C}$, unless otherwise specified)	11
Table 9.	UVLO characteristics ($V_I = 5.5\text{ V}$, $I_O = \text{rated current}$, $T_J = 25^\circ\text{C}$, unless otherwise specified)	12
Table 10.	OCx pin characteristics ($V_I = 5.5\text{ V}$, $I_O = \text{rated current}$, $T_J = 25^\circ\text{C}$, unless otherwise specified)	12
Table 11.	ENx pin characteristics ($V_I = 5.5\text{ V}$, $I_O = \text{rated current}$, $T_J = 25^\circ\text{C}$, unless otherwise specified)	12
Table 12.	SO-8 mechanical data	37
Table 13.	MSOP8 mechanical data	38
Table 14.	Reel mechanical data	40
Table 15.	Document revision history	41

List of figures

Figure 1.	Block diagram	6
Figure 2.	Pinout	7
Figure 3.	Turn-on for $C_{LOAD} = 1 \mu F$	13
Figure 4.	Turn-on for $C_{LOAD} = 100 \mu F$	14
Figure 5.	Turn-on for $C_{LOAD} = 470 \mu F$	14
Figure 6.	Turn-off for $C_{LOAD} = 1 \mu F$	15
Figure 7.	Turn-off for $C_{LOAD} = 100 \mu F$	15
Figure 8.	Turn-off for $C_{LOAD} = 470 \mu F$	16
Figure 9.	Turn-on for $C_{LOAD} = 1 \mu F$	16
Figure 10.	Turn-on for $C_{LOAD} = 100 \mu F$	17
Figure 11.	Turn-on for $C_{LOAD} = 470 \mu F$	17
Figure 12.	Turn-off for $C_{LOAD} = 1 \mu F$	18
Figure 13.	Turn-off for $C_{LOAD} = 100 \mu F$	18
Figure 14.	Turn-off for $C_{LOAD} = 470 \mu F$	19
Figure 15.	UVLO, V_I rising	20
Figure 16.	UVLO, V_I falling	20
Figure 17.	Overcurrent protection characteristics, $V_I = 3 V$, $R_{LOAD} = 2.2 \Omega$	21
Figure 18.	Overcurrent protection characteristics, $V_I = 5 V$, $R_{LOAD} = 2.2 \Omega$	21
Figure 19.	I_{CC} versus V_I	22
Figure 20.	t_r versus V_I	22
Figure 21.	t_f versus V_I	23
Figure 22.	$R_{ds(on)}$ versus V_I	23
Figure 23.	Turn-on for $C_{LOAD} = 1 \mu F$	24
Figure 24.	Turn-on for $C_{LOAD} = 100 \mu F$	25
Figure 25.	Turn-on for $C_{LOAD} = 470 \mu F$	25
Figure 26.	Turn-off for $C_{LOAD} = 1 \mu F$	26
Figure 27.	Turn-off for $C_{LOAD} = 100 \mu F$	26
Figure 28.	Turn-off for $C_{LOAD} = 470 \mu F$	27
Figure 29.	Turn-on for $C_{LOAD} = 1 \mu F$	27
Figure 30.	Turn-on for $C_{LOAD} = 100 \mu F$	28
Figure 31.	Turn-on for $C_{LOAD} = 470 \mu F$	28
Figure 32.	Turn-off for $C_{LOAD} = 1 \mu F$	29
Figure 33.	Turn-off for $C_{LOAD} = 100 \mu F$	29
Figure 34.	Turn-off for $C_{LOAD} = 470 \mu F$	30
Figure 35.	UVLO, V_I rising	30
Figure 36.	UVLO, V_I falling	31
Figure 37.	Overcurrent protection characteristics, $V_I = 3 V$, $R_{LOAD} = 1 \Omega$	32
Figure 38.	Overcurrent protection characteristics, $V_I = 5 V$, $R_{LOAD} = 1 \Omega$	32
Figure 39.	I_{CC} versus V_I	33
Figure 40.	t_r versus V_I	33
Figure 41.	t_f versus V_I	34
Figure 42.	$R_{ds(on)}$ versus V_I	34
Figure 43.	SO-8 package outline	36
Figure 44.	MSOP8 package outline	38
Figure 45.	SO-8 carrier tape	39
Figure 46.	MSOP8 carrier tape	39
Figure 47.	Reel information	40

1 Block diagram

Figure 1. Block diagram

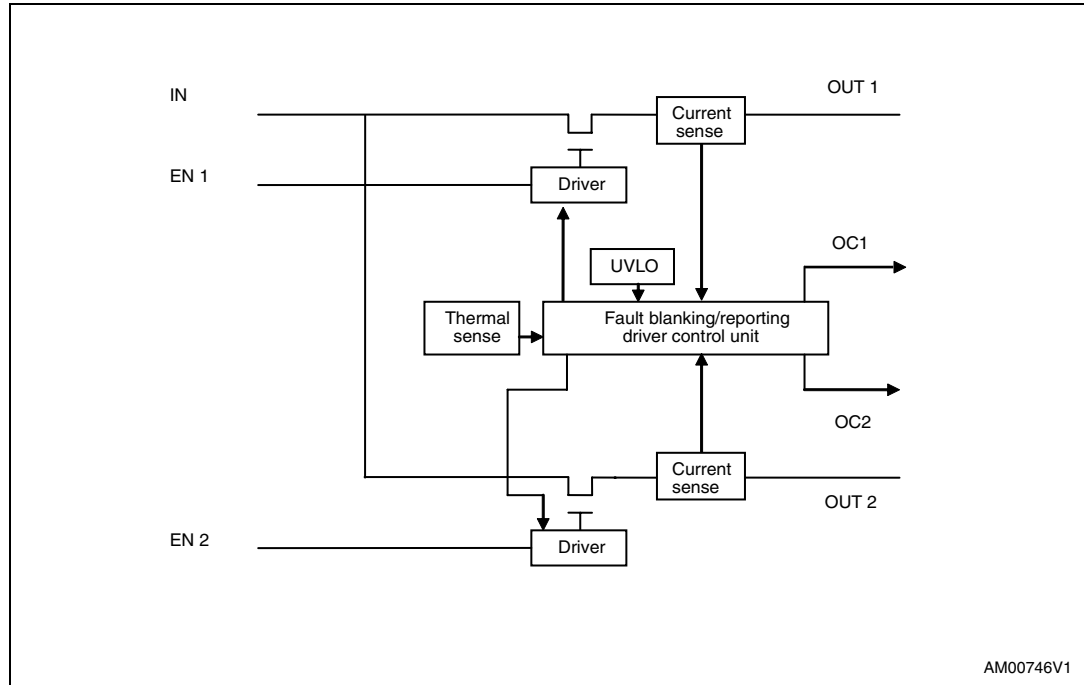

2 Pin descriptions

Figure 2. Pinout

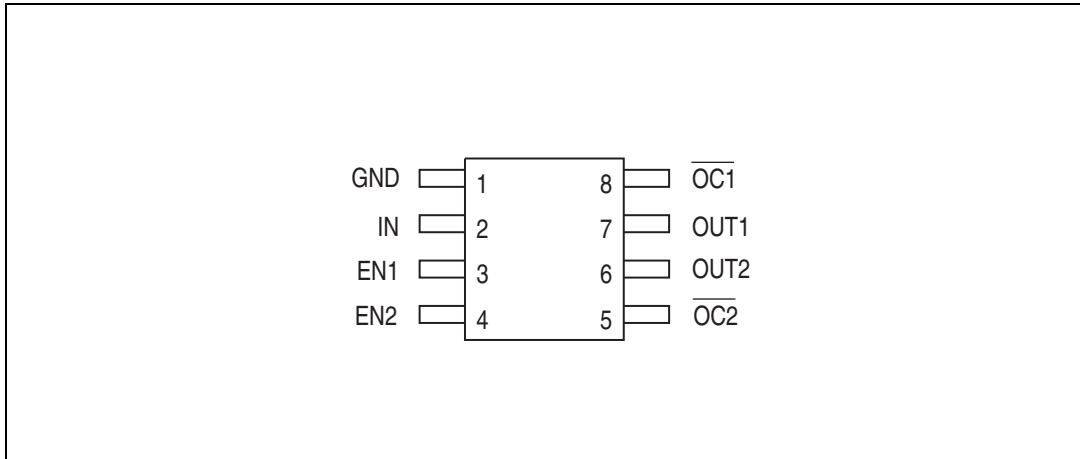

Table 2. Pin descriptions

Pin number	Name	Type	Function
1	GND	—	Ground
2	IN	—	V _{CC} input, 2.7 - 5.5 V
3	$\overline{EN1}/EN1$	I	Channel 1 active low (STMPS2242 and STMPS2262) or active high (STMPS2252 and STMPS2272) enable
4	$\overline{EN2}/EN2$	I	Channel 2 active low (STMPS2242 and STMPS2262) or active high (STMPS2252 and STMPS2272) enable
5	$\overline{OC2}$	O	Open drain output for fault indication of channel 2
6	OUT2	—	Output of channel 2
7	OUT1	—	Output of channel 1
8	$\overline{OC1}$	O	Open drain output for fault indication of channel 1

3 Functional description

3.1 Fault blanking

The STMPS devices feature a 10 ms fault blanking. Fault blanking allows current-limit faults, including momentary short-circuit faults that occur when hot-swapping a capacitive load, and also ensures that no fault is issued during power-up. When a load transient causes the device to enter current limit, an internal counter starts. If the load fault persists beyond the 10 ms fault-blanking timeout, the FAULT output asserts “low”. Load-transient faults less than 10 ms (typ.) do not cause a FAULT output assertion. Only current-limit faults have fault-blanking. Die overtemperature faults and input voltage drops below the UVLO threshold cause an immediate fault output.

3.2 Overcurrent/overtemperature protection

In overcurrent or short-circuit condition, the switch limits the current at 500 mA for STMPS2242/STMPS2252 and 1000 mA for STMPS2262/STMPS2272. If the temperature of the die goes above the limit value, the switch turns OFF.

3.3 Reverse current blocking

When the switch is OFF, or when the STMPS device is not powered ($V_{CC}=0$ V), the switch behaves as a Hi-Z at the output pin, ensuring that no reverse current will flow into the device when $V_I < V_O$.

Note: In the case where the switch is ON, and a voltage higher than V_I is applied to the OUT pin, a reverse current will occur.

3.4 UVLO

When the input voltage drops below the threshold value, the power switch turns OFF to prevent improper operation due to low voltage.

4 Maximum rating

Stressing the device above the rating listed in the absolute maximum ratings table may cause permanent damage to the device. These are stress ratings only and operation of the device at these or any other conditions above those indicated in the operating sections of this specification is not implied. Exposure to absolute maximum rating conditions for extended periods may affect device reliability.

4.1 Absolute maximum rating

Table 3. Absolute maximum ratings

Symbol	Parameter	Value	Unit
V_I	Input voltage range	-0.3 – 6.0	V
V_O	Output voltage range	-0.3 – ($V_I + 0.3$)	V
V_{IENx}	EN input voltage range	-0.3 – 6.0	V
I_O	Continuous output current	Internally limited	
ESD	ESD protection level	8	kV
T_J	Junction operating temperature	-40 to 125	°C
T_{STG}	Storage temperature	-55 to 150	°C
T_R	Thermal resistance (MSOP8)	220	°C/W
T_R	Thermal resistance (SO-8)	160	°C/W

4.2 Recommended operating conditions

Table 4. Recommended operating conditions

Symbol	Parameter	Value			Unit
		Min	Typ	Max	
V_I	Input voltage	2.7	5.0	5.5	V
V_O	Output voltage	0	5.0	5.5	V
I_O (STMPS2242 STMPS2252)	Continuous output current	0	-	500	mA
I_O (STMPS2262 STMPS2272)	Continuous output current	0	-	1000	mA

5 Electrical specifications

Table 5. Electrical characteristics

Symbol	Parameter	Test conditions	Value			Unit
			Min	Typ	Max	
R _{ds(on)}	Static drain source ON state resistance	V _I = 2.7 V T _J = 25°C		120	160	mΩ
		V _I = 5.0 V T _J = 25°C;		105	115	mΩ
R _{ds(on)}	Static drain source ON state resistance	V _I = 2.7 V -40 < T _J < 125°C			200	mΩ
		V _I = 5.0 V -40 < T _J < 125°C			140	
t _r	Output rise time (STMPS2242,STMPS2252)	V _I = 5.0 V R _{LOAD} = 10 Ω C _{LOAD} = 1 μF	0.05		2	ms
	Output rise time (STMPS2262,STMPS2272)	V _I = 5.0 V R _{LOAD} = 10 Ω C _{LOAD} = 1 μF	0.05		2	ms
t _f	Output fall time (STMPS2242,STMPS2252)	V _I = 5.0 V R _{LOAD} = 10 Ω C _{LOAD} = 1 μF	0.05		2	ms
	Output fall time (STMPS2262,STMPS2272)	V _I = 5.0 V R _{LOAD} = 10 Ω C _{LOAD} = 1 μF	0.05		2	ms

Table 6. Current limit characteristics
(V_I = 5.5 V, I_O = rated current, T_J = 25°C, unless otherwise specified)

Symbol	Parameter	Test condition	Value			Unit
			Min	Typ	Max	
I _{OS} (STMPS2242 STMPS2252)	Short circuit output current	V _I = 5 V OUT connected to GND through 10 mΩ load, device enabled into short circuit	0.6	0.8	1.0	A
I _{OS} (STMPS2262 STMPS2272)			1.1	1.6	2.0	A

Table 7. Supply current characteristics
 ($V_I = 5.5\text{ V}$, $I_O = \text{rated current}$, $T_J = 25^\circ\text{C}$, unless otherwise specified)

Symbol	Parameter	Test condition	Value			Unit
			Min	Typ	Max	
I_{off}	Switch turned off	No load Switch is off		9	14	μA
		No load Switch is off $-40 < T_J < 125^\circ\text{C}$			16	
I_{on}	Switch turned on	No load Switch is on		50	70	μA
		No load Switch is on $-40 < T_J < 125^\circ\text{C}$			85	
$I_{leakage}$	Output leakage current (1)	I_{off} (grounded output) - I_{off} (floating output)		1	2	μA
		I_{off} (grounded output) - I_{off} (floating output) $-40 < T_J < 125^\circ\text{C}$		1	6	
$I_{reverse}$	Reversed leakage current	Switch is off $V_I < V_O$, Output connected to 5.5 V, 25°C		1	2	μA
		Switch is off $V_I < V_O$ Output connected to 5.5 V, 125°C		1	10	

1. $I_{leakage} = I_{off-ground} - I_{off}$, where $I_{off-ground}$ = current into IN when switch is off and output is grounded

Table 8. Thermal characteristics
 ($V_I = 5.5\text{ V}$, $I_O = \text{rated current}$, $T_J = 25^\circ\text{C}$, unless otherwise specified)

Symbol	Parameter	Test condition	Value			Unit
			Min	Typ	Max	
T1	Thermal shutdown threshold		135			$^\circ\text{C}$
T2	Recovery from thermal shutdown		125			$^\circ\text{C}$
Hysteresis				10		$^\circ\text{C}$

Table 9. UVLO characteristics(V_I = 5.5 V, I_O = rated current, T_J = 25°C, unless otherwise specified)

Symbol	Parameter	Test condition	Value			Unit
			Min	Typ	Max	
V _{UVLO}	Undervoltage lockout threshold		2.0		2.5	V
Hysteresis				75		mV

Table 10. OCx pin characteristics(V_I = 5.5 V, I_O = rated current, T_J = 25°C, unless otherwise specified)

Symbol	Parameter	Test condition	Value			Unit
			Min	Typ	Max	
OC blanking	OCx assertion and de-assertion		4	8	15	ms
V _O	Output low voltage	I _O = 5 mA	–	–	0.4	V
I _{off}	Off current	V _{OC} = 2.7 V, 5.5 V (No OC condition)	–	–	1.0	μA

Table 11. ENx pin characteristics(V_I = 5.5 V, I_O = rated current, T_J = 25°C, unless otherwise specified)

Symbol	Parameter	Test condition	Value			Unit
			Min	Typ	Max	
V _{IH}	High level input voltage	V _I = 2.7 V to 5.5 V	2.0	–	–	V
V _{IL}	Low level input voltage	V _I = 4.5 V to 5.5 V	–	–	0.8	V
		V _I = 2.7 V to 4.5 V	–	–	0.4	V
I _I	Input current	V _{IENx} = 0 V or V _I	-0.5	–	0.5	μA
t _{on}	Turn ON time ⁽¹⁾	R _{LOAD} = 10 Ω C _{LOAD} = 100 μF	–	–	5	ms
t _{off}	Turn OFF time ⁽¹⁾	R _{LOAD} = 10 Ω C _{LOAD} = 100 μF	–	–	10	ms

1. Not tested in production, specified by design.

6 Typical operating characteristics

6.1 STMP2242, STMP2252 characteristics

The waveforms and characteristics shown in this section pertain to the STMP2252 device. The STMP2242 is expected to have the same characteristics with inverted EN input function. All measurements are at ambient temperature 25 °C.

6.1.1 Turn-on/off characteristics for $V_I = 3\text{ V}$, $R_{LOAD} = 6\ \Omega$

Figure 3. Turn-on for $C_{LOAD} = 1\ \mu\text{F}$



Figure 4. Turn-on for $C_{LOAD} = 100 \mu F$



Figure 5. Turn-on for $C_{LOAD} = 470 \mu F$

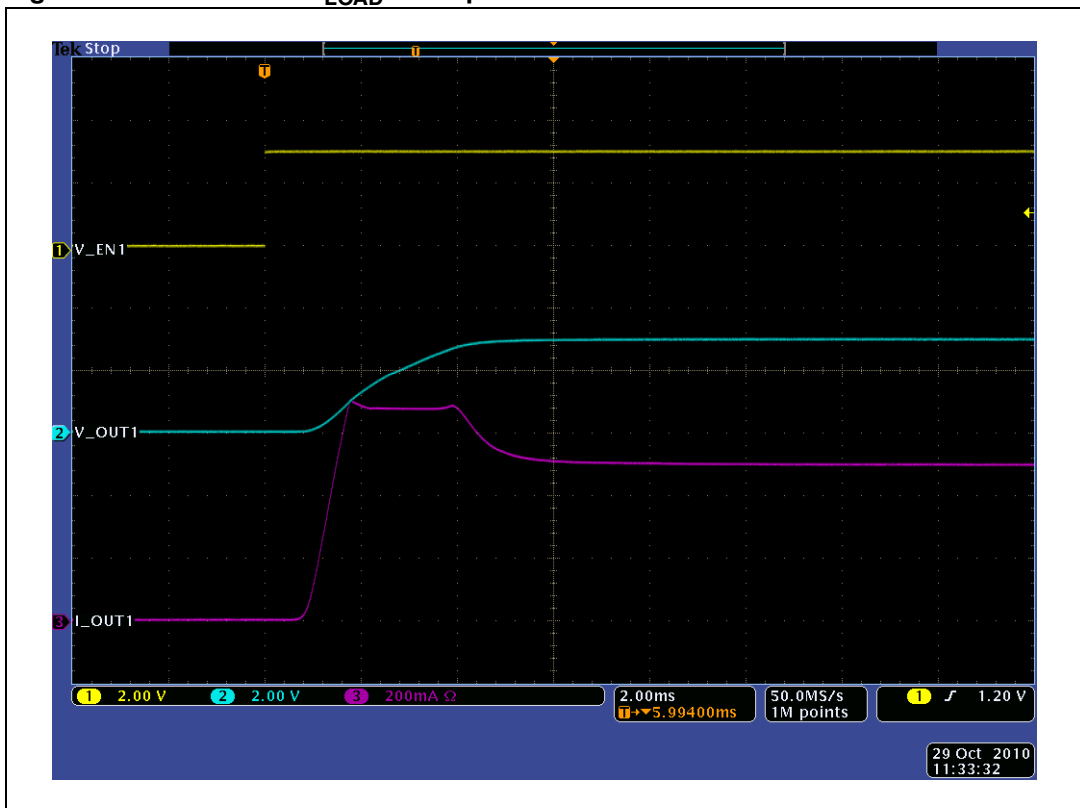

Figure 6. Turn-off for $C_{LOAD} = 1 \mu F$

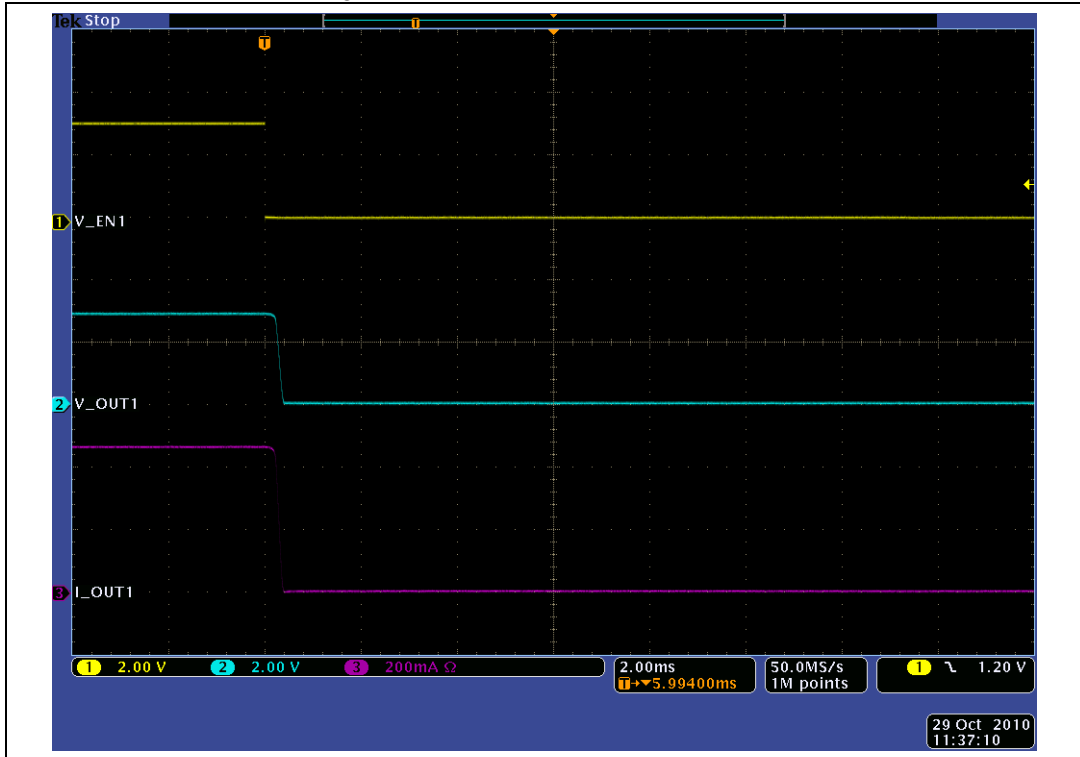

Figure 7. Turn-off for $C_{LOAD} = 100 \mu F$

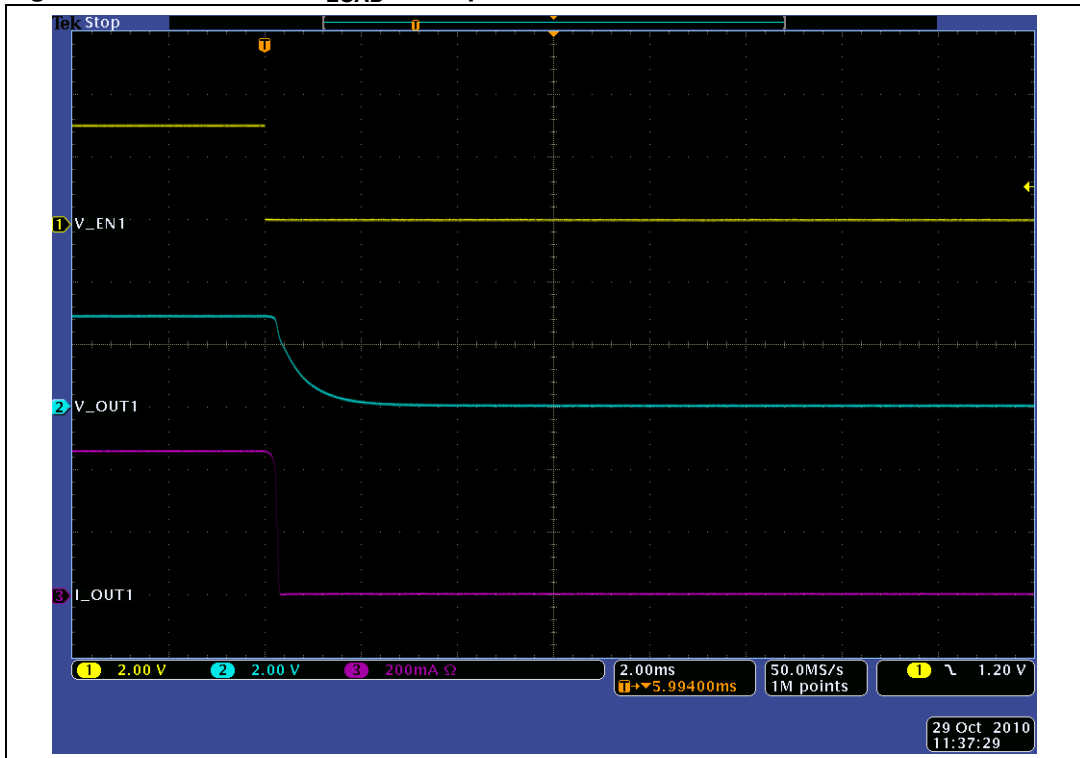
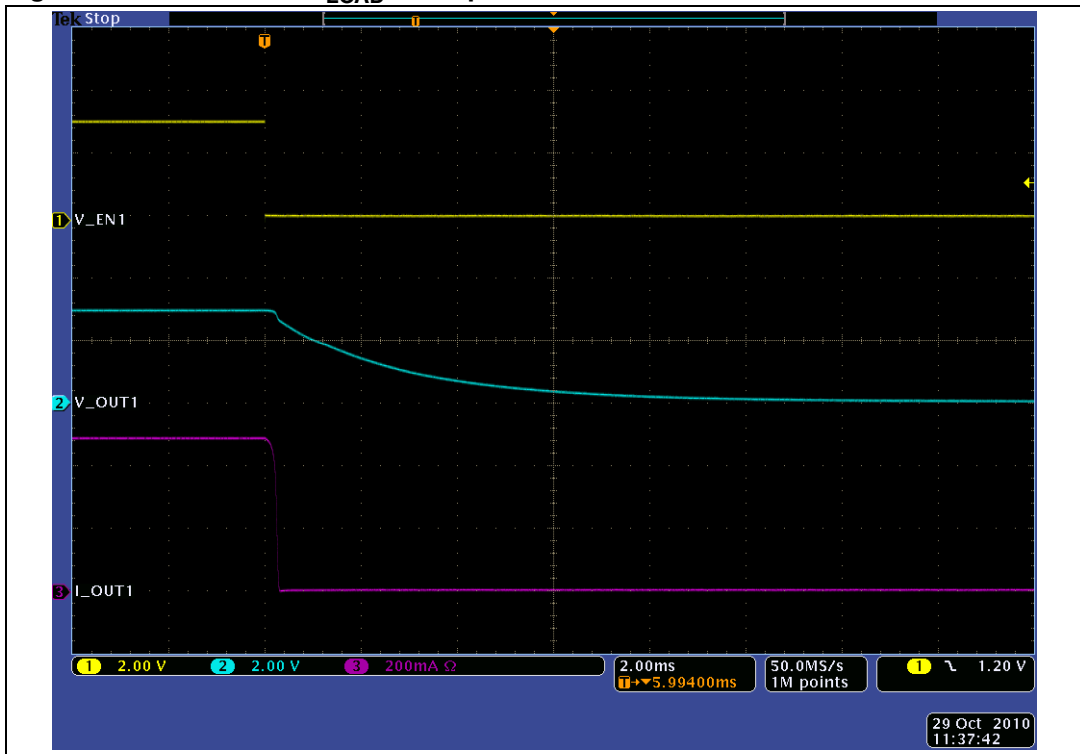

Figure 8. Turn-off for $C_{LOAD} = 470 \mu F$



6.1.2 Turn-on/off characteristics for $V_I = 5 V$, $R_{LOAD} = 10 \Omega$

Figure 9. Turn-on for $C_{LOAD} = 1 \mu F$

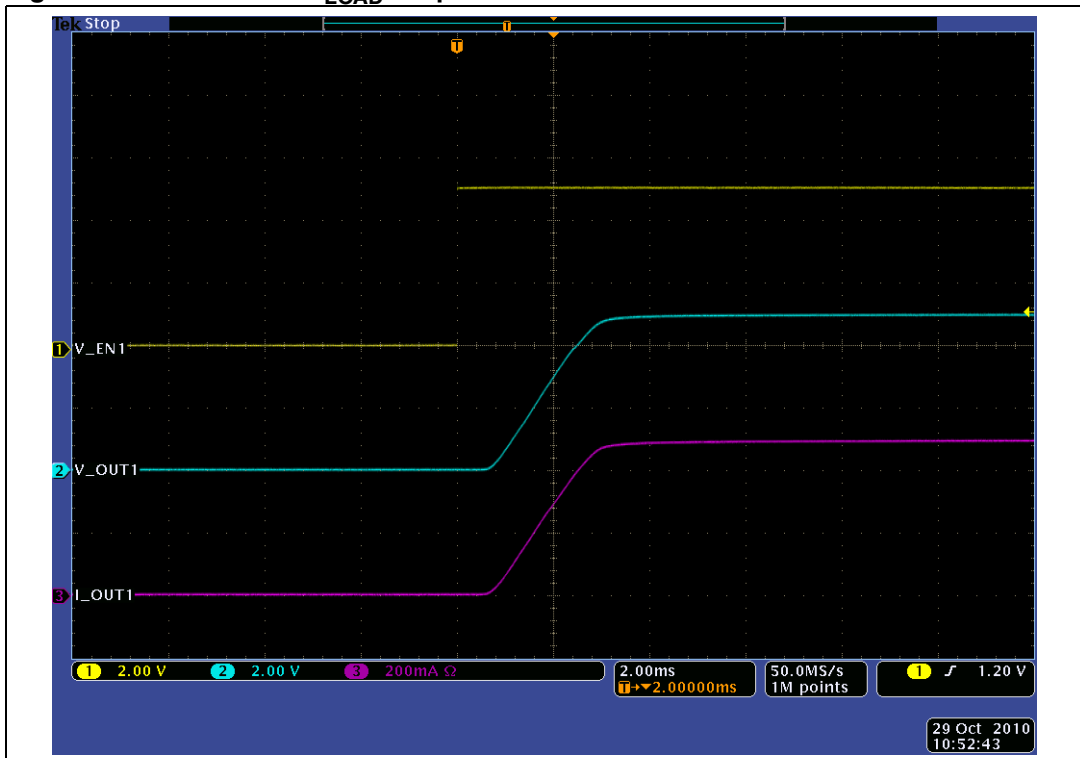

Figure 10. Turn-on for $C_{LOAD} = 100 \mu F$



Figure 11. Turn-on for $C_{LOAD} = 470 \mu F$

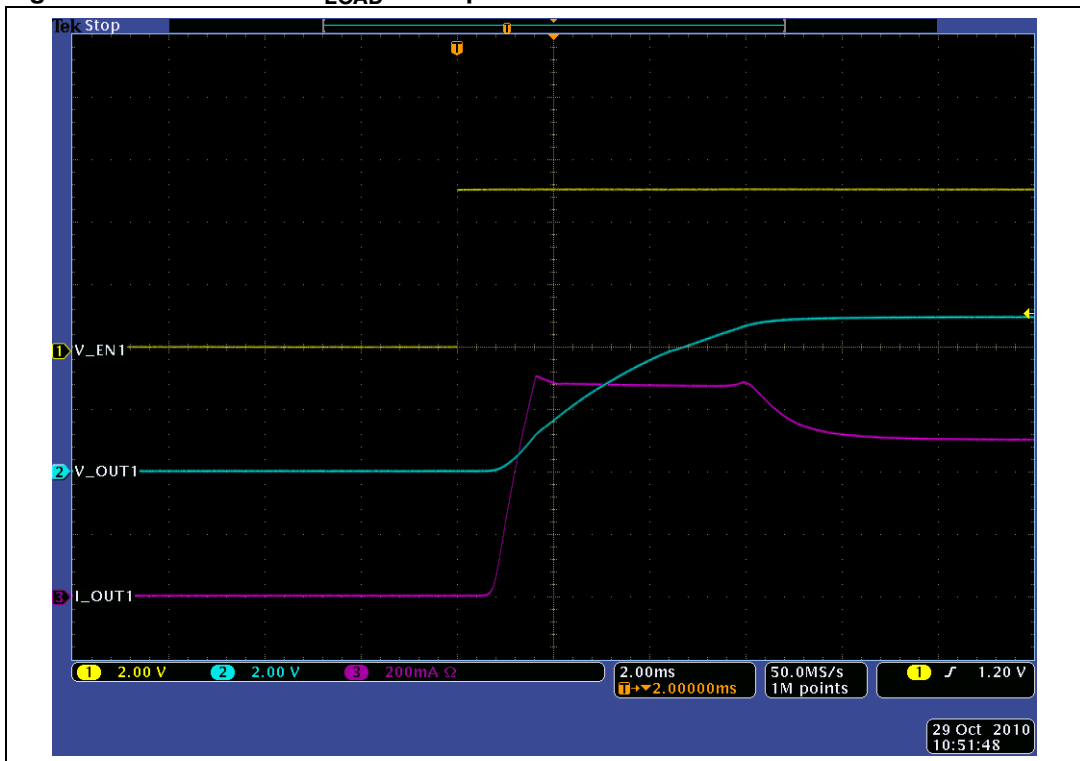

Figure 12. Turn-off for $C_{LOAD} = 1 \mu F$

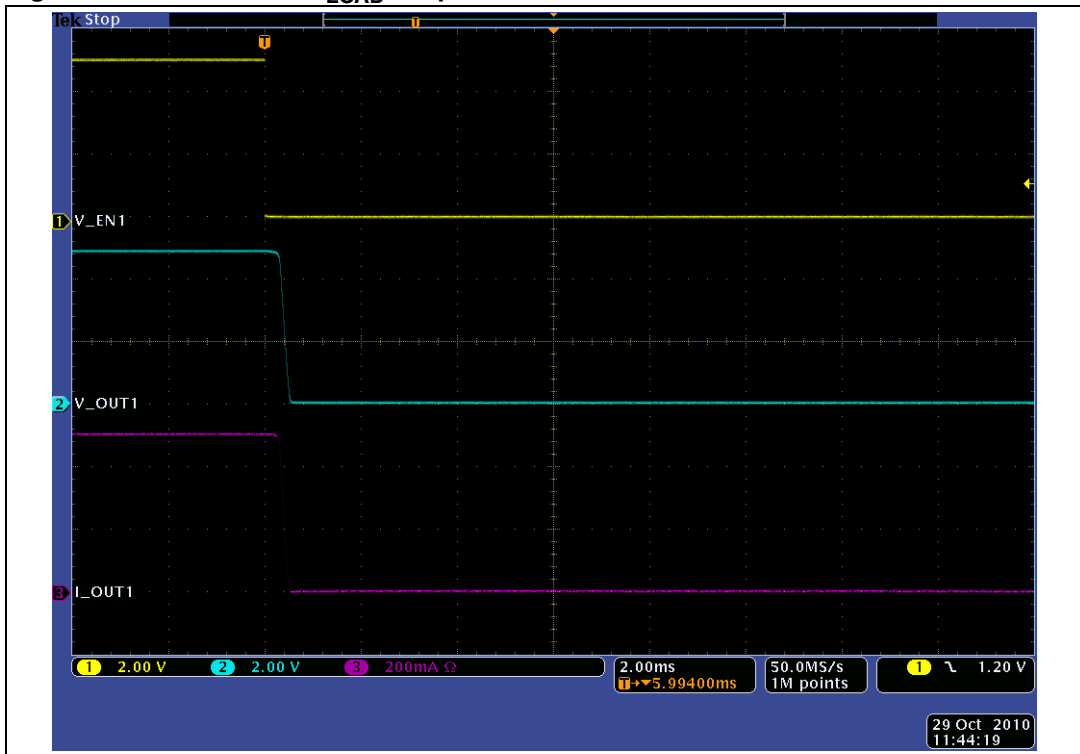

Figure 13. Turn-off for $C_{LOAD} = 100 \mu F$

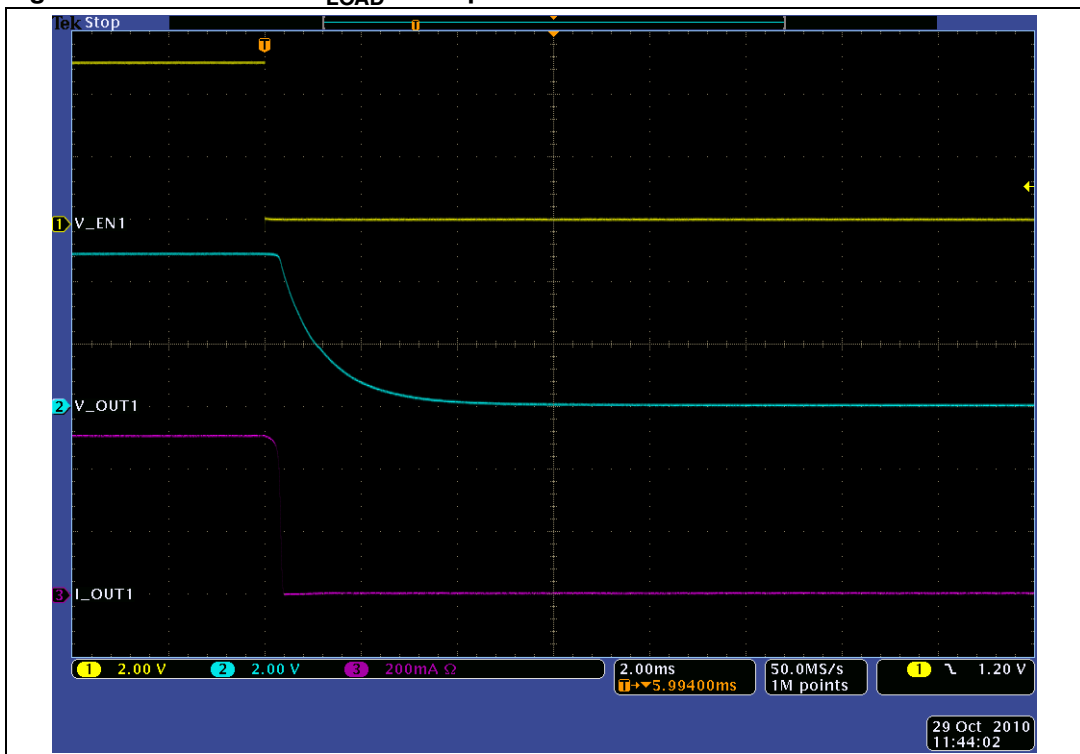
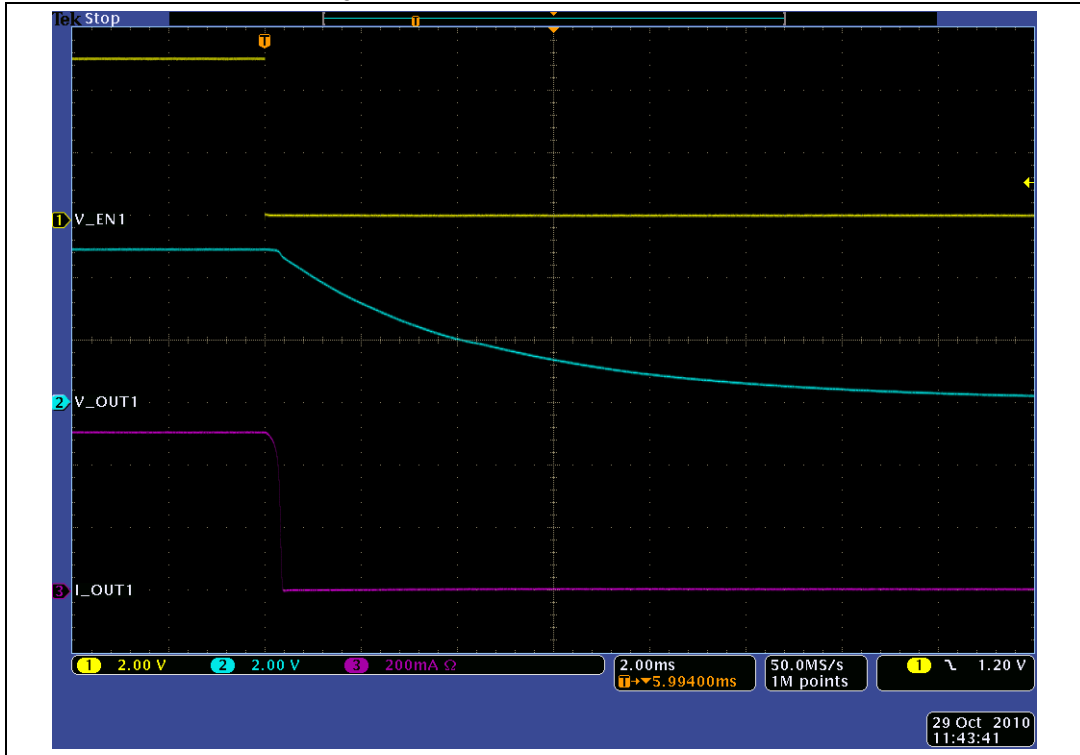

Figure 14. Turn-off for $C_{LOAD} = 470 \mu F$



6.1.3 UVLO characteristics

Figure 15. UVLO, V_I rising

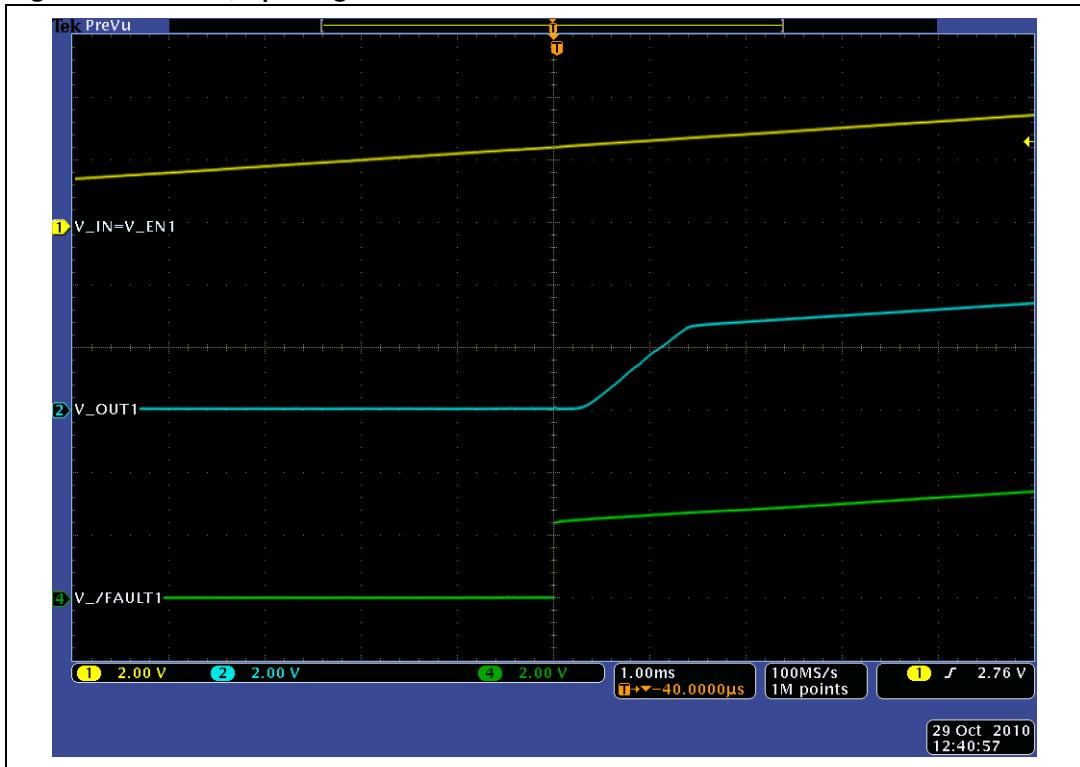

Figure 16. UVLO, V_I falling



6.1.4 Overcurrent protection characteristics

Figure 17. Overcurrent protection characteristics, $V_I = 3\text{ V}$, $R_{LOAD} = 2.2\ \Omega$

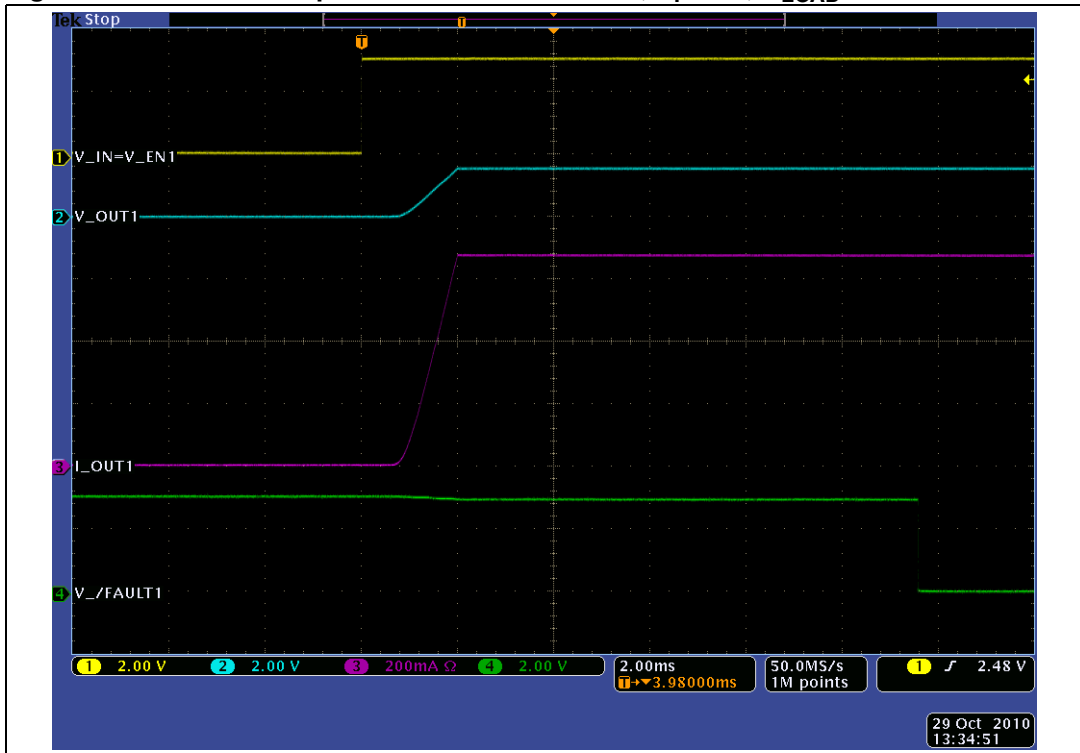
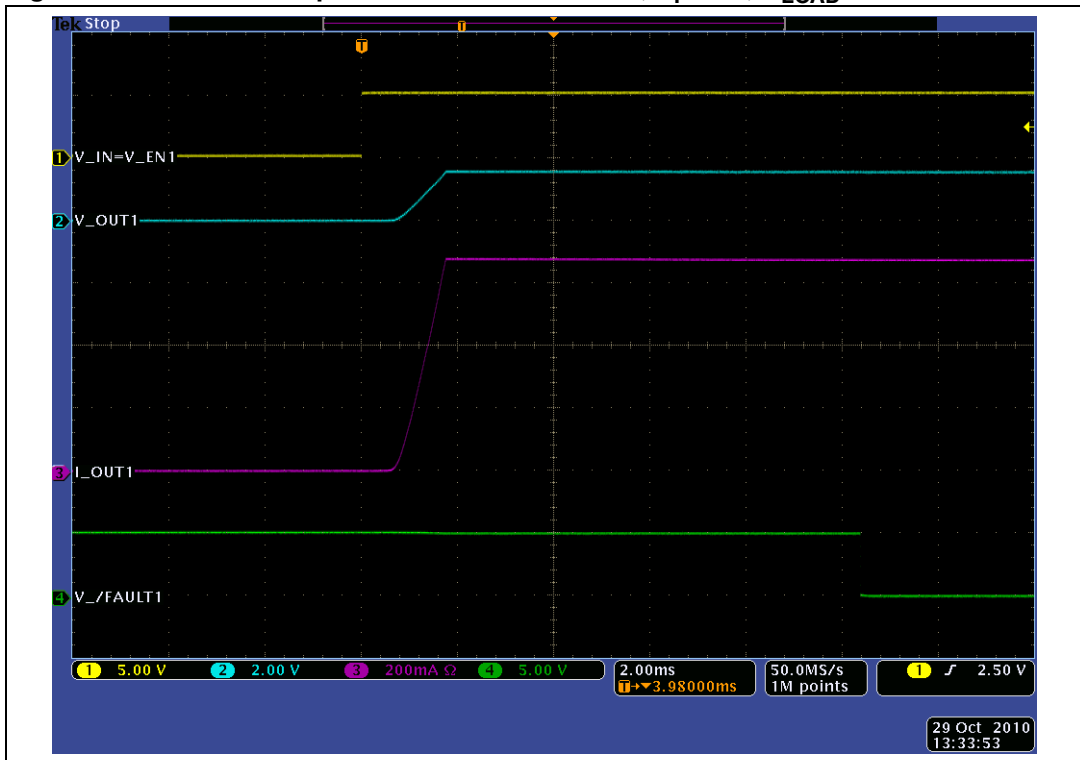

Figure 18. Overcurrent protection characteristics, $V_I = 5\text{ V}$, $R_{LOAD} = 2.2\ \Omega$



6.1.5 Other electrical characteristics

Figure 19. I_{CC} versus V_I

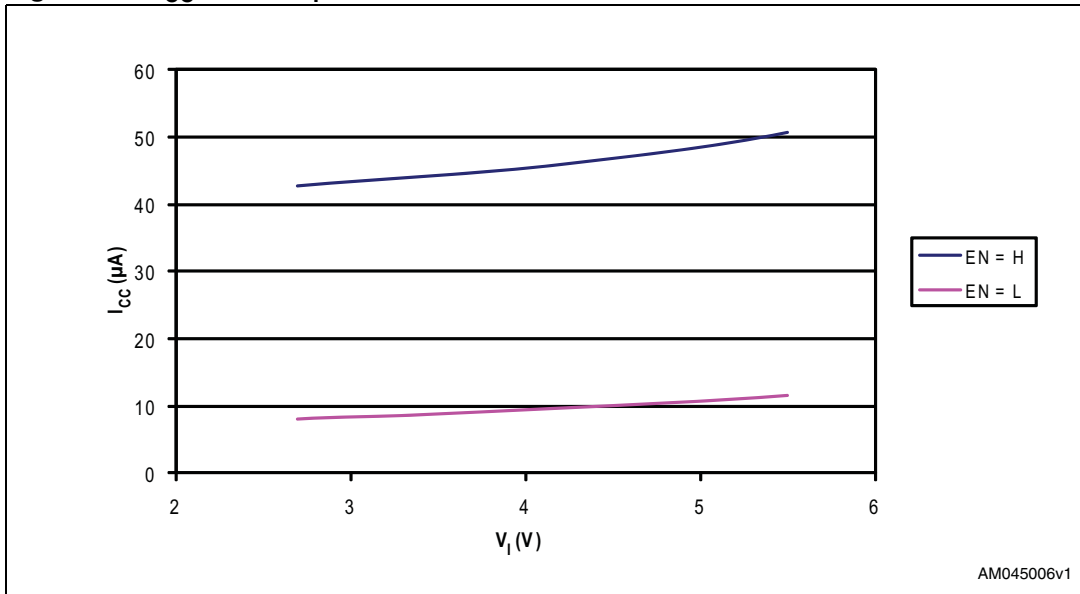

Figure 20. t_r versus V_I

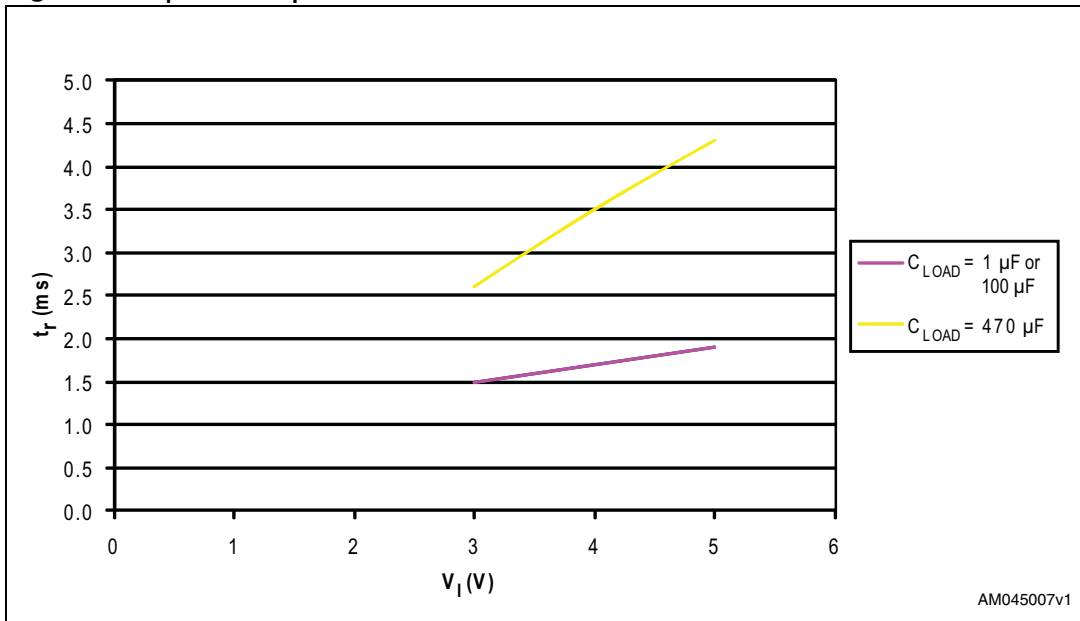

Figure 21. t_f versus V_I

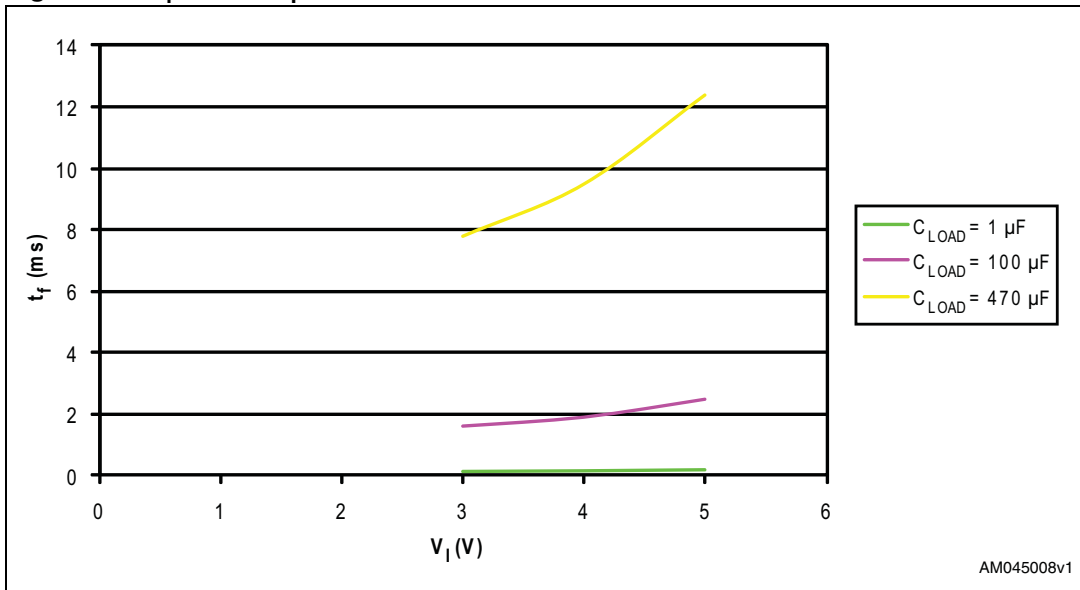
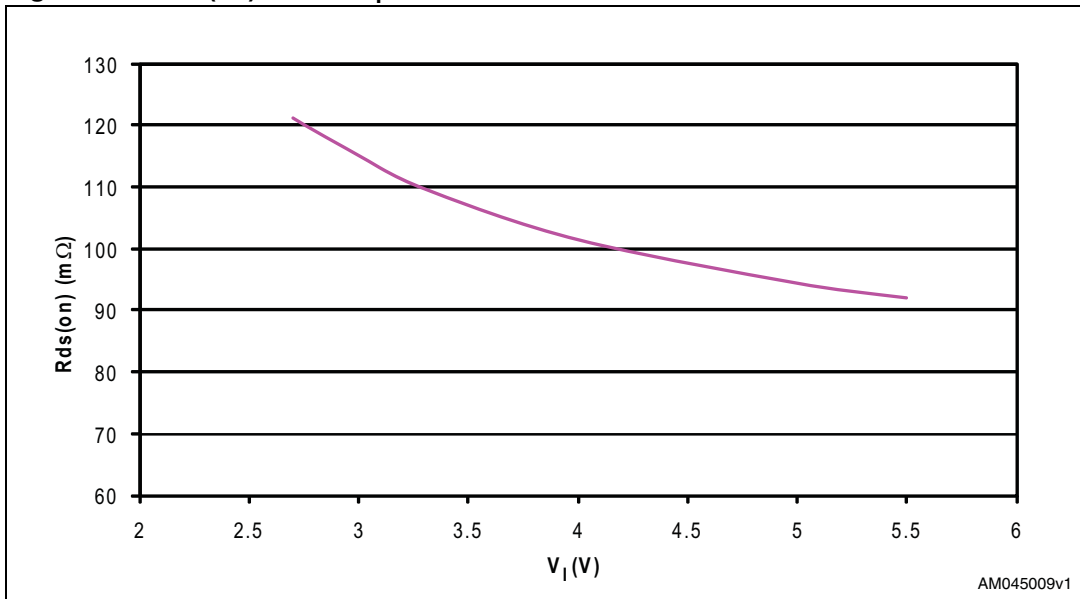

Figure 22. $R_{ds(on)}$ versus V_I



6.2 STMPS2262, STMPS2272 characteristics

The waveforms and characteristics shown in this section pertain to the STMPS2272 device. The STMPS2262 is expected to have the same characteristics with inverted EN input function. All measurements are at ambient temperature 25 °C.

6.2.1 Turn-on/off characteristics for $V_I = 3\text{ V}$, $R_{LOAD} = 3\ \Omega$

Figure 23. Turn-on for $C_{LOAD} = 1\ \mu\text{F}$



Figure 24. Turn-on for $C_{LOAD} = 100 \mu F$



Figure 25. Turn-on for $C_{LOAD} = 470 \mu F$



Figure 26. Turn-off for $C_{LOAD} = 1 \mu F$

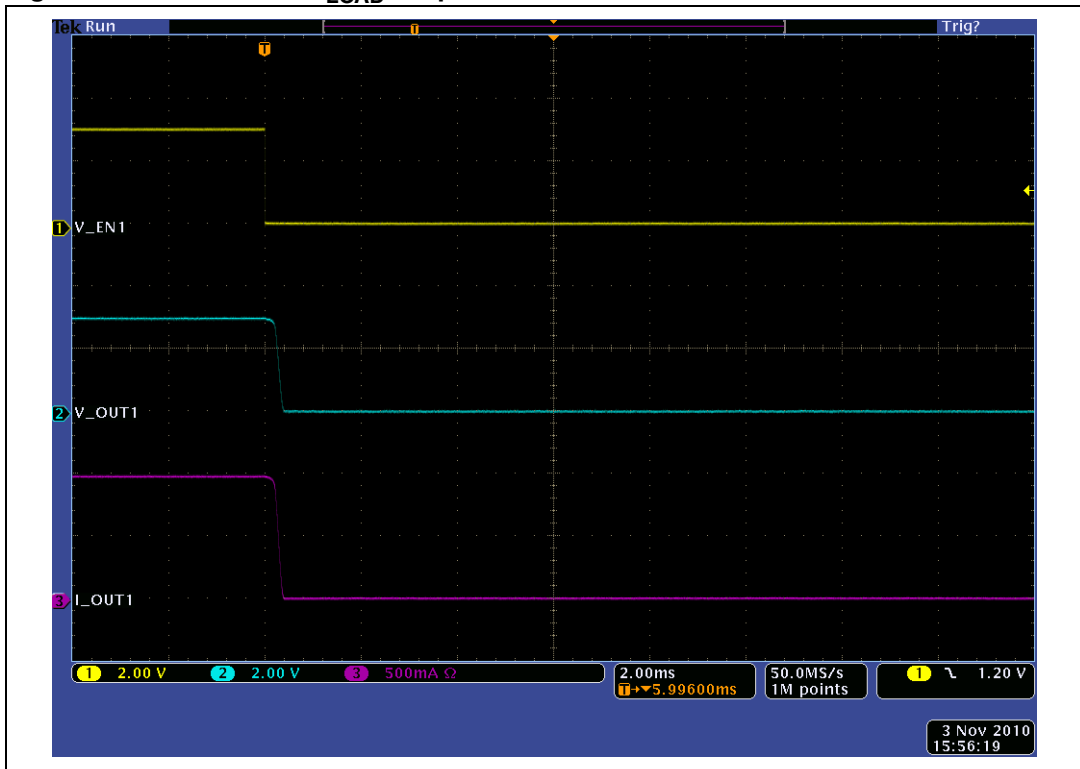

Figure 27. Turn-off for $C_{LOAD} = 100 \mu F$

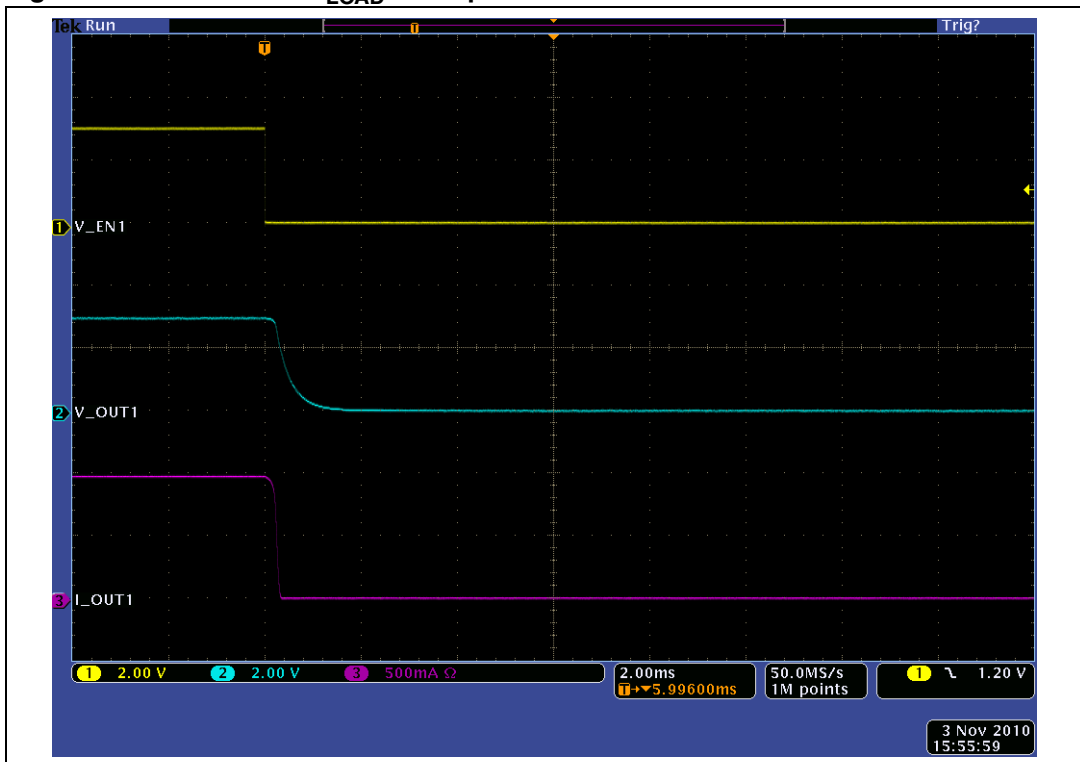
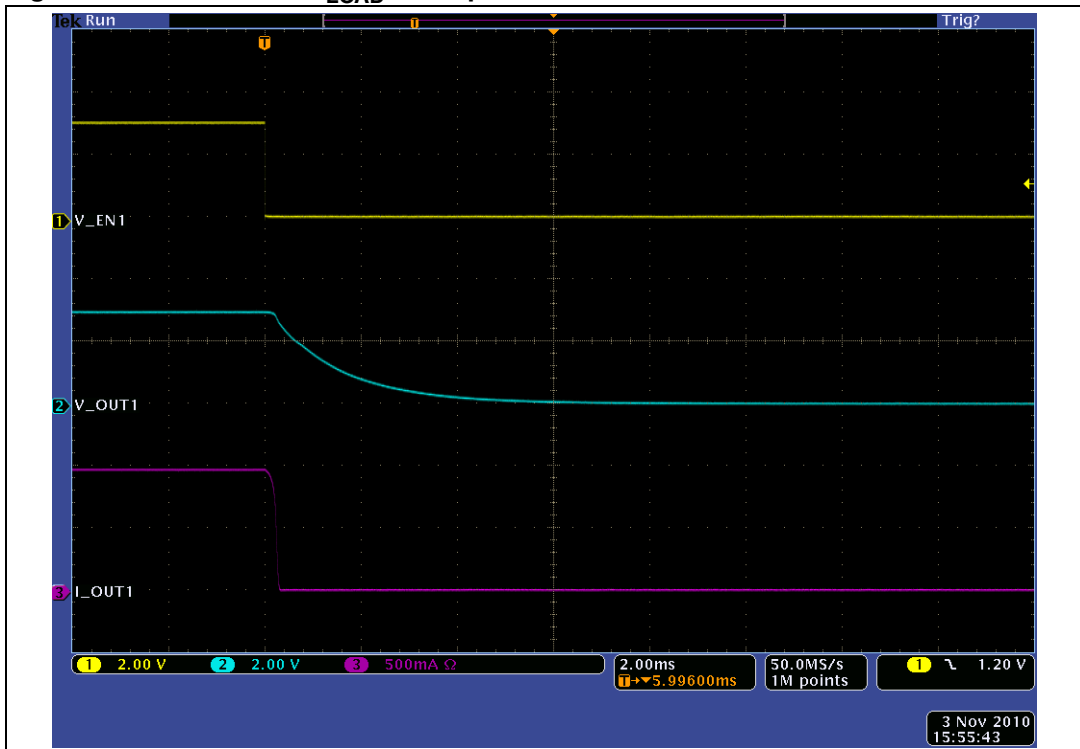

Figure 28. Turn-off for $C_{LOAD} = 470 \mu F$



6.2.2 Turn-on/off characteristics for $V_I = 5 V$, $R_{LOAD} = 5 \Omega$

Figure 29. Turn-on for $C_{LOAD} = 1 \mu F$



Figure 30. Turn-on for $C_{LOAD} = 100 \mu F$

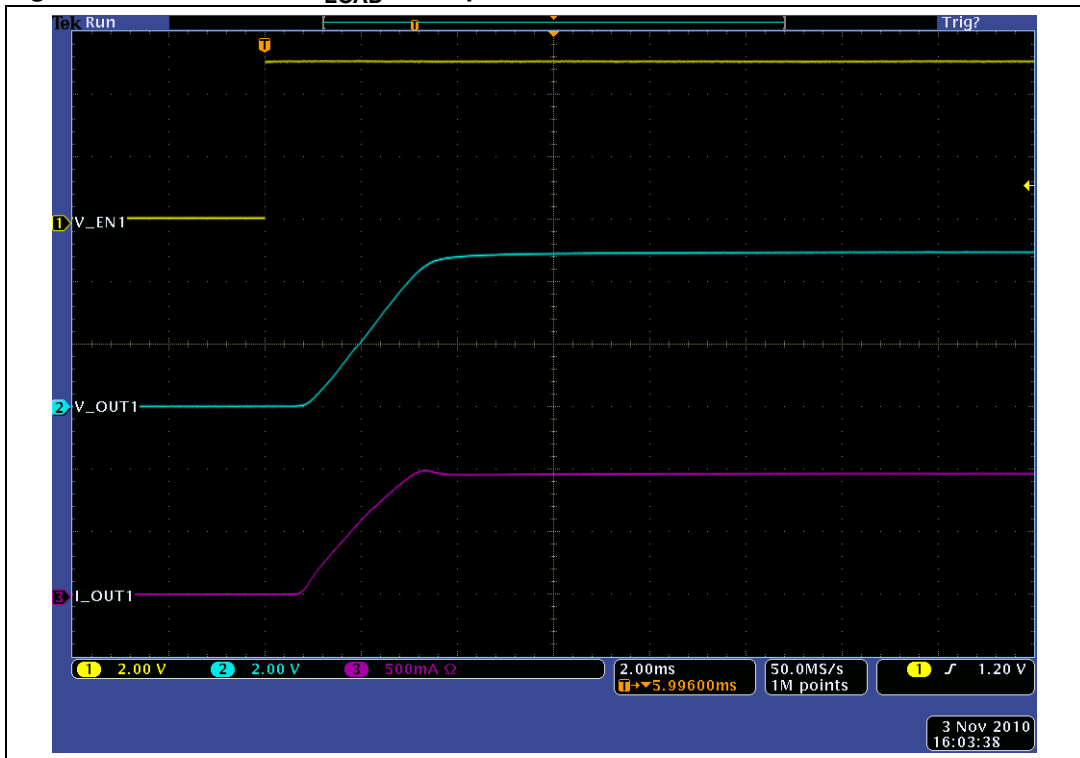

Figure 31. Turn-on for $C_{LOAD} = 470 \mu F$

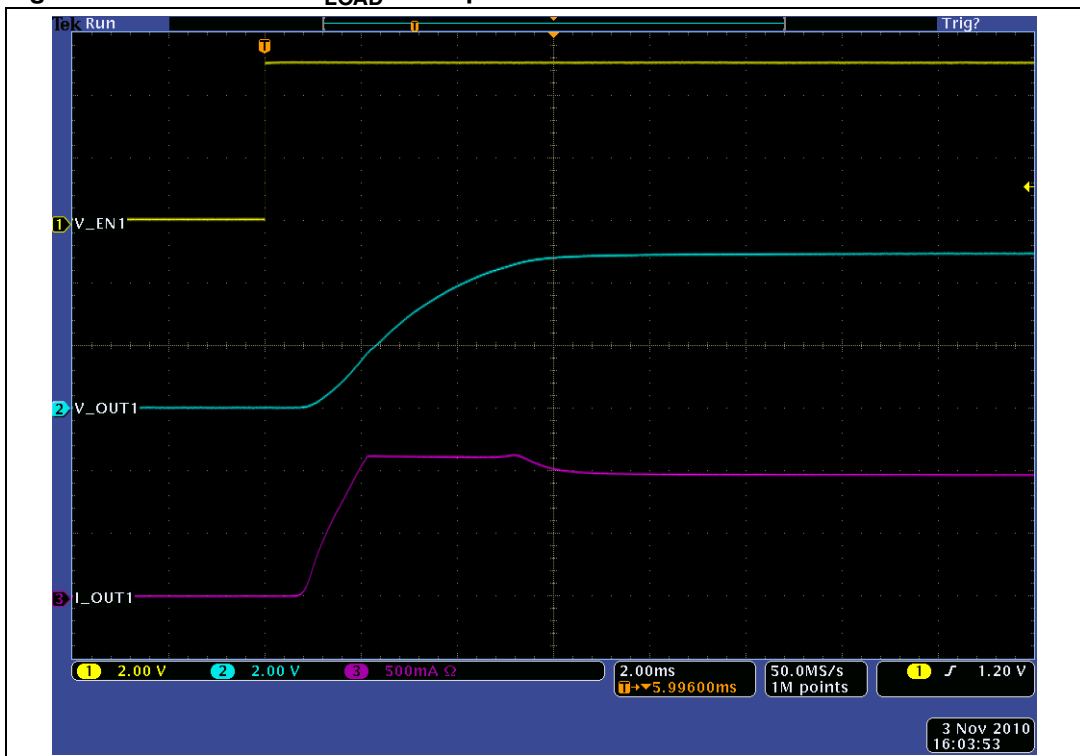

Figure 32. Turn-off for $C_{LOAD} = 1 \mu F$

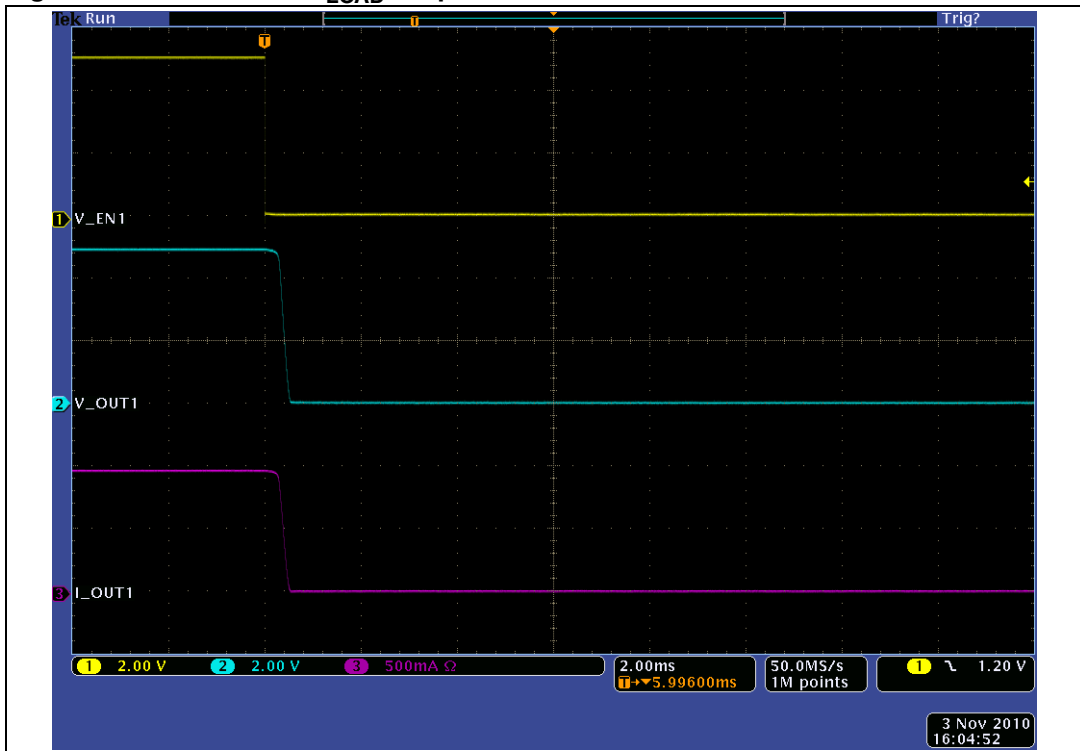
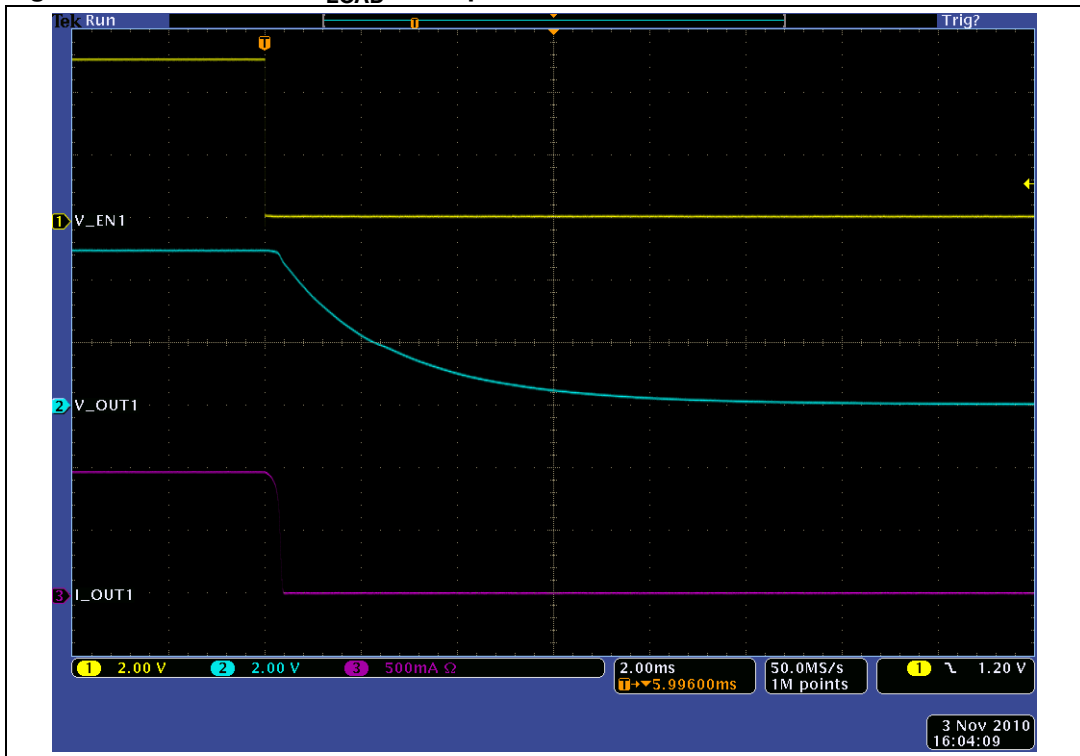

Figure 33. Turn-off for $C_{LOAD} = 100 \mu F$



Figure 34. Turn-off for $C_{LOAD} = 470 \mu F$



6.2.3 UVLO characteristics

Figure 35. UVLO, V_I rising

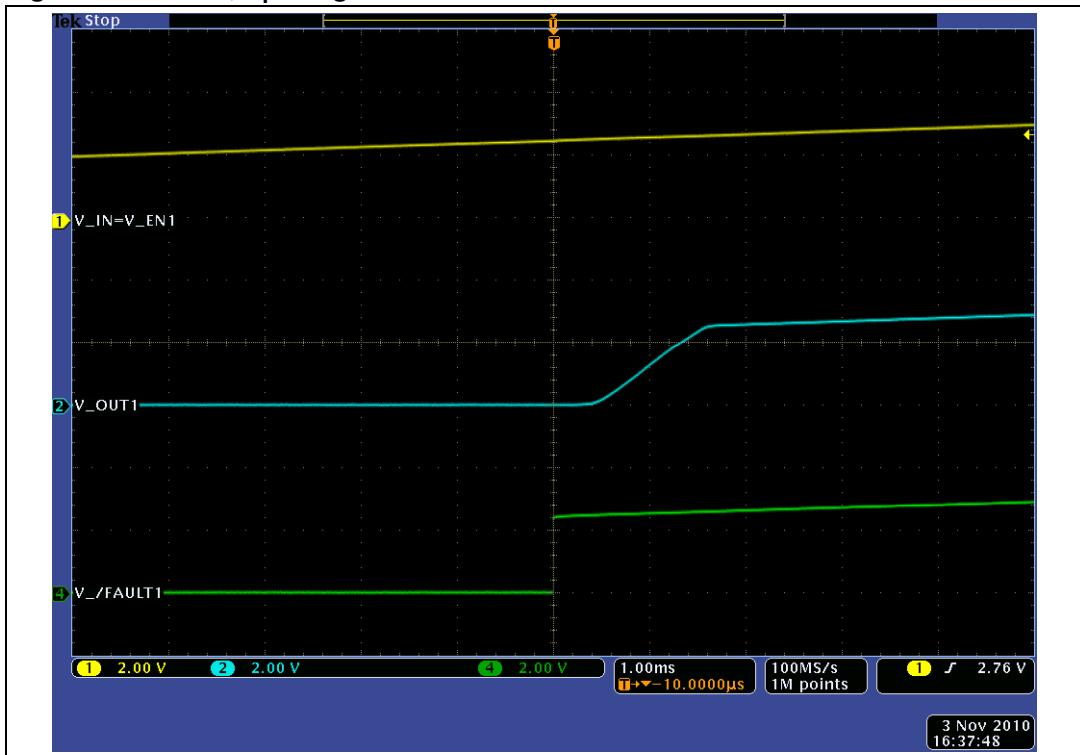
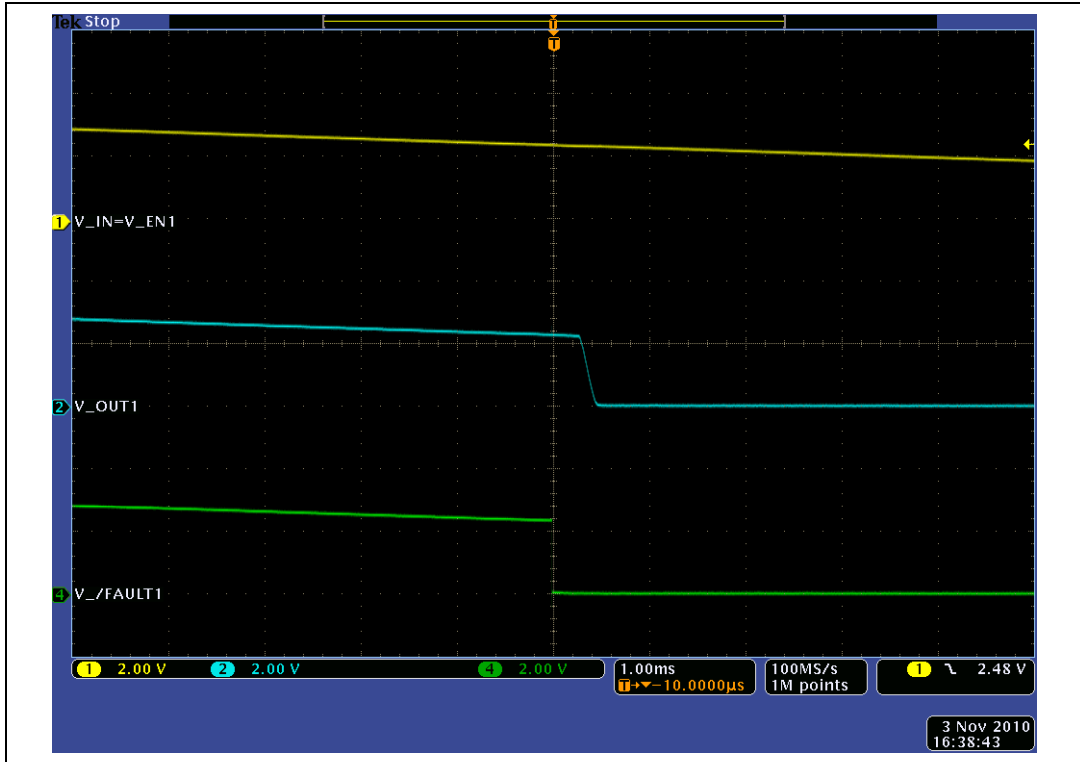

Figure 36. UVLO, V_I falling



6.2.4 Overcurrent protection characteristics

Figure 37. Overcurrent protection characteristics, $V_I = 3\text{ V}$, $R_{LOAD} = 1\ \Omega$



Figure 38. Overcurrent protection characteristics, $V_I = 5\text{ V}$, $R_{LOAD} = 1\ \Omega$

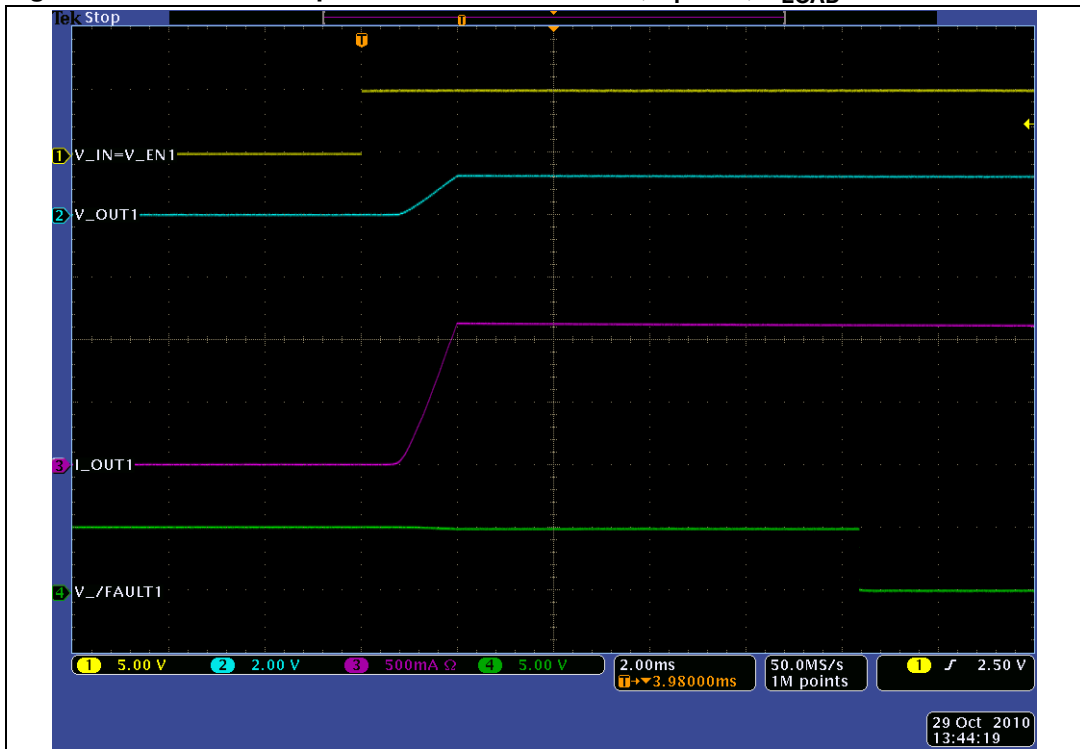

6.2.5 Other electrical characteristics

Figure 39. I_{CC} versus V_I

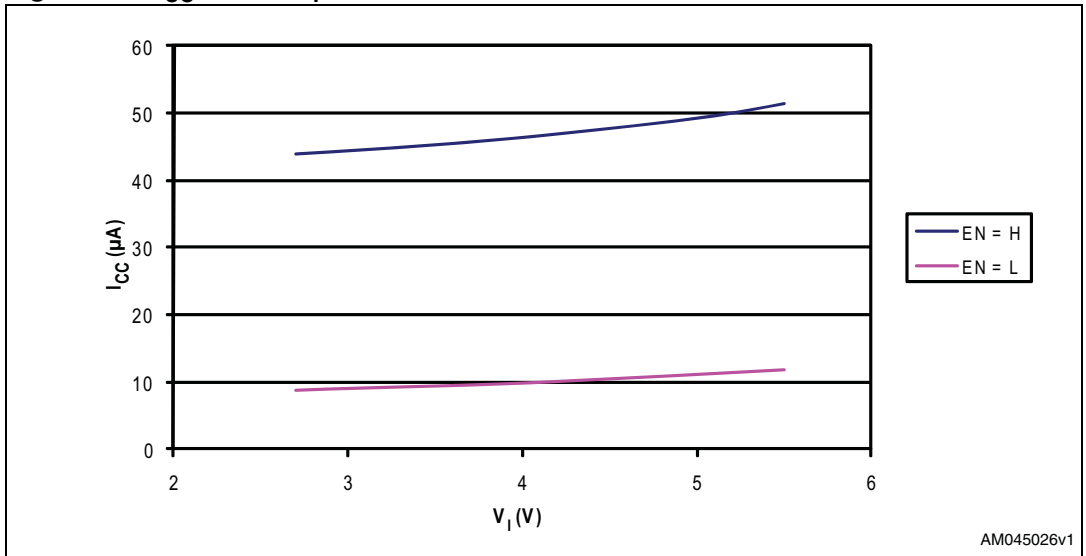

Figure 40. t_r versus V_I

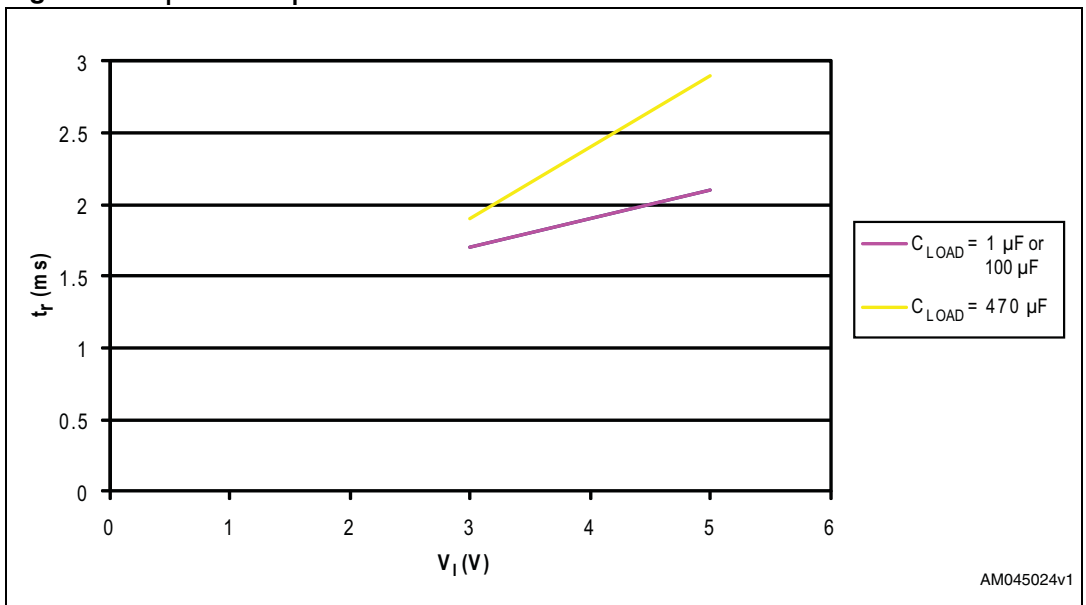

Figure 41. t_f versus V_I

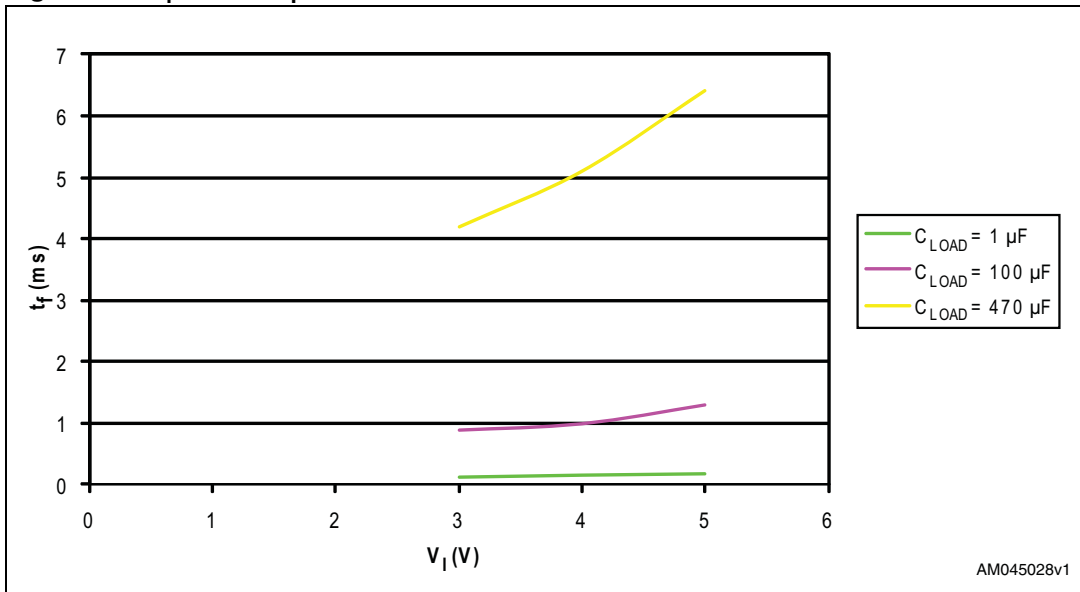
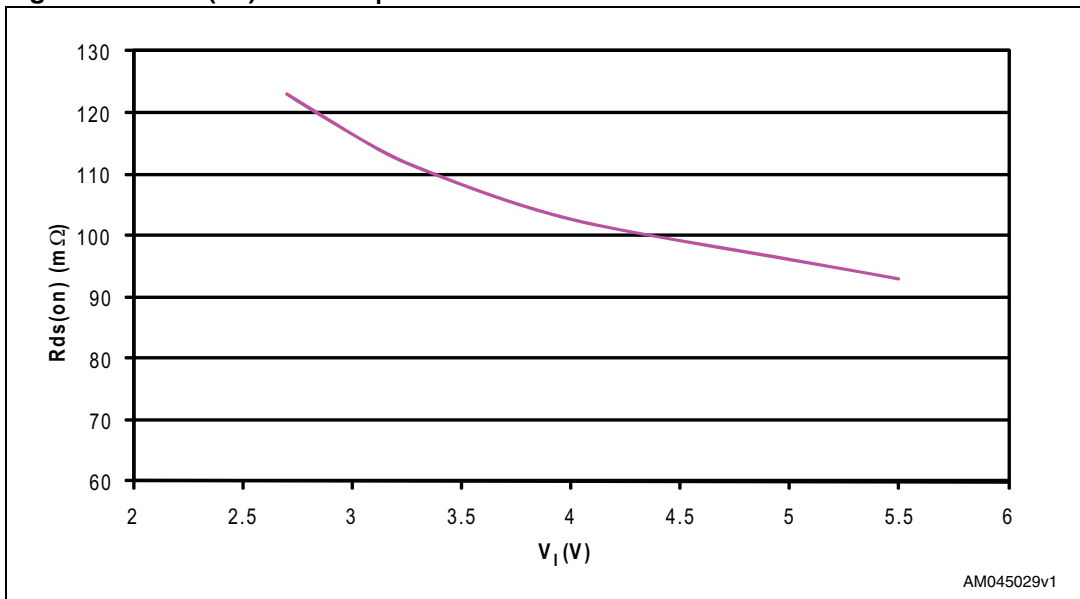

Figure 42. $R_{ds(on)}$ versus V_I



7 Application information

7.1 Input and output capacitors

Input and output capacitors improve the performance of the device; the actual capacitance should be optimized for the particular application. For all applications, a 0.1 μF or greater ceramic bypass capacitor between IN and GND as close to the device as possible is recommended for local noise decoupling. This precaution also reduces ringing on the input due to power supply transients.

An additional capacitor may be needed on the input to reduce input voltage overshoots from exceeding the absolute maximum voltage of the device during heavy transient conditions. This is especially important during bench testing when long, inductive cables are used to connect the evaluation board to the bench power supply. The value of 100 μF may be adequate in most situations.

An output capacitor is not required for device functionality, but placing a high-value (in the order of 10 - 100 μF) electrolytic capacitor on the output pins is recommended when large transient currents are expected on the output.

8 Package mechanical data

In order to meet environmental requirements, ST offers these devices in different grades of ECOPACK[®] packages, depending on their level of environmental compliance. ECOPACK[®] specifications, grade definitions and product status are available at: www.st.com. ECOPACK[®] is an ST trademark.

Figure 43. SO-8 package outline

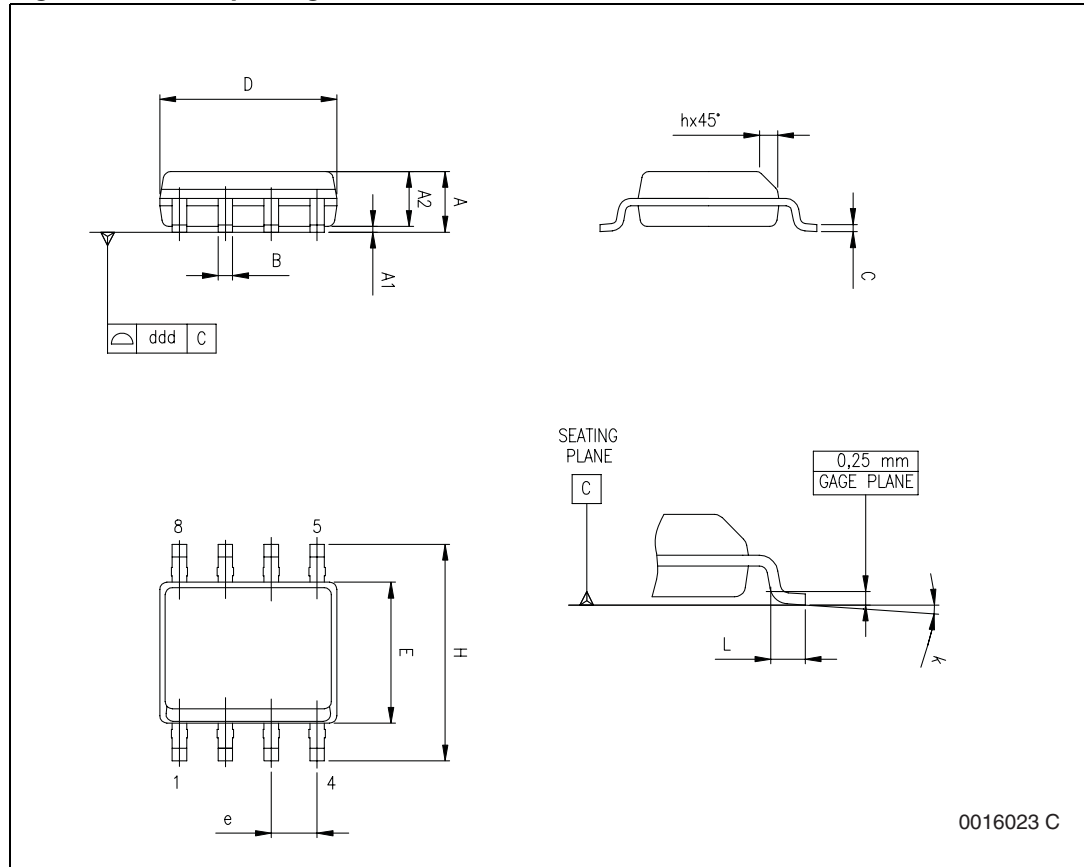

Table 12. SO-8 mechanical data

Symbol	Millimeters		
	Min	Typ	Max
A	1.35	—	1.75
A1	0.10	—	0.25
A2	1.10	—	1.65
B	0.33	—	0.51
C	0.19	—	0.25
D ⁽¹⁾	4.80	—	5.00
E	3.80	—	4.00
e	—	1.27	—
H	5.80	—	6.20
h	0.25	—	0.50
L	0.40	—	1.27
k	0° (min.), 8° (max.)		
ddd	—	—	0.10

1. Dimension D does not include mold flash, protrusions or gate burrs. Mold flash, protrusions or gate burrs shall not exceed 0.15 mm (0.006 inch) in total (both sides).

Figure 44. MSOP8 package outline

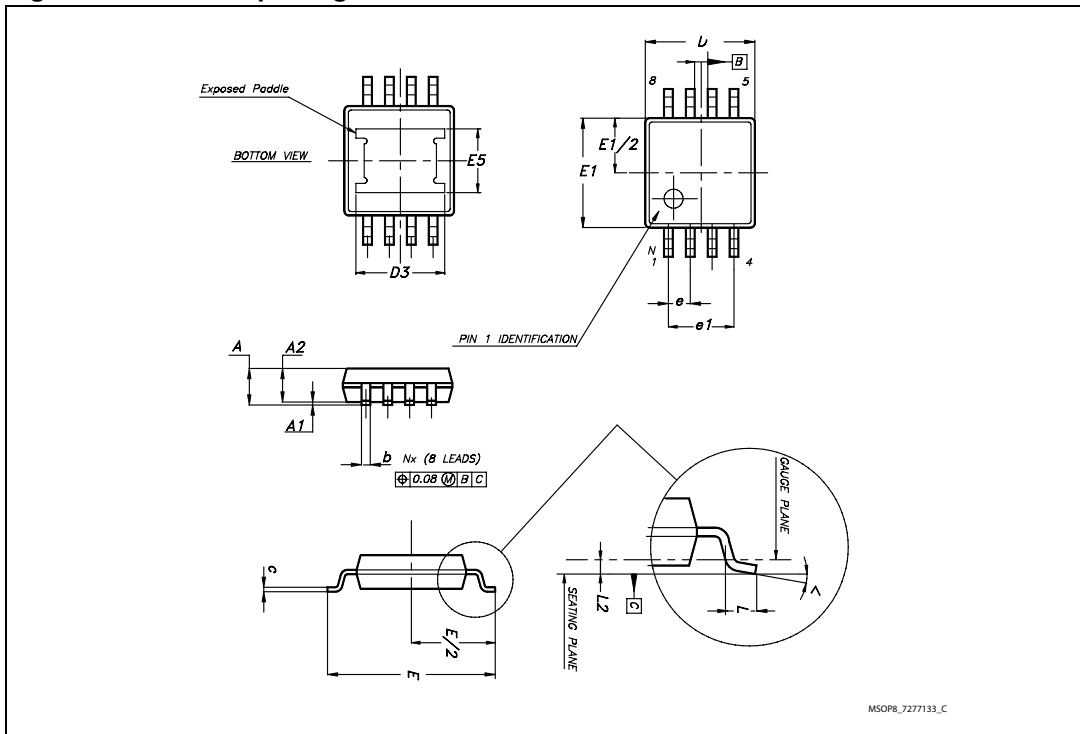

Table 13. MSOP8 mechanical data

Symbol	Millimeters		
	Min	Typ	Max
A	—	—	1.10
A1	0	—	0.15
A2	0.75	0.85	0.95
b	0.22	—	0.40
c	0.08	—	0.23
D	2.90	3.00	3.10
D3	—	2.16	—
E	4.67	4.90	5.07
E1	2.90	3.00	3.10
E5	—	1.73	—
e	—	0.65	—
e1	—	1.95	—
L	0.40	—	0.80
L2	—	0.25	—
α	0°	—	6°

Figure 45. SO-8 carrier tape

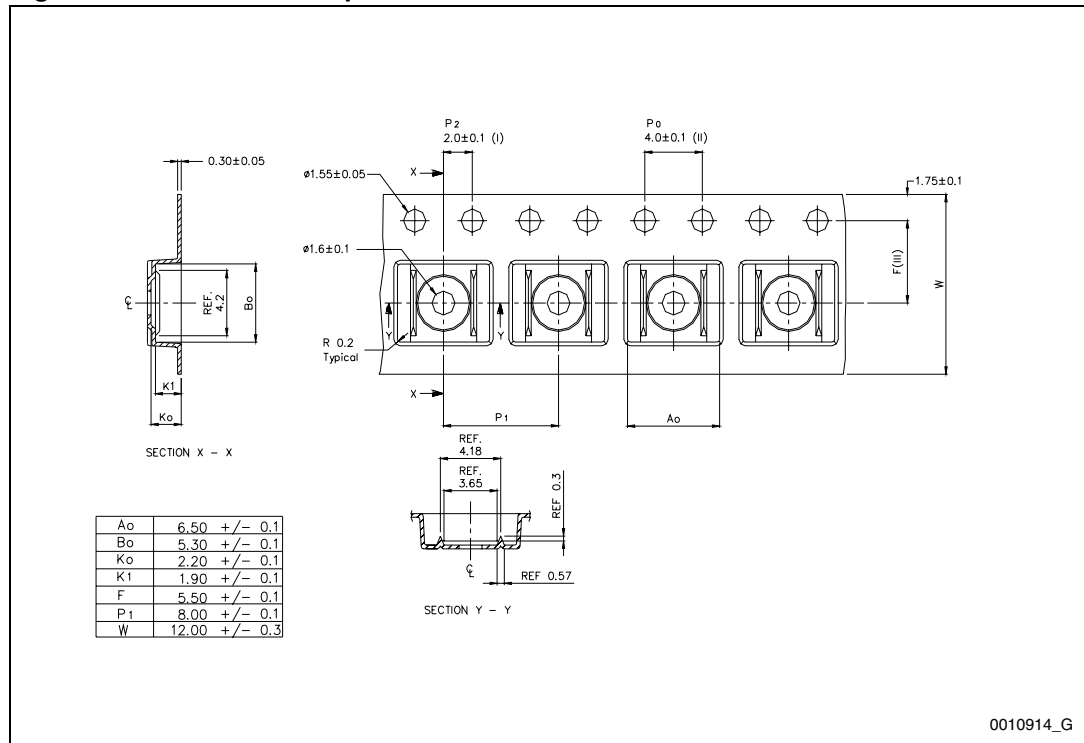

Figure 46. MSOP8 carrier tape

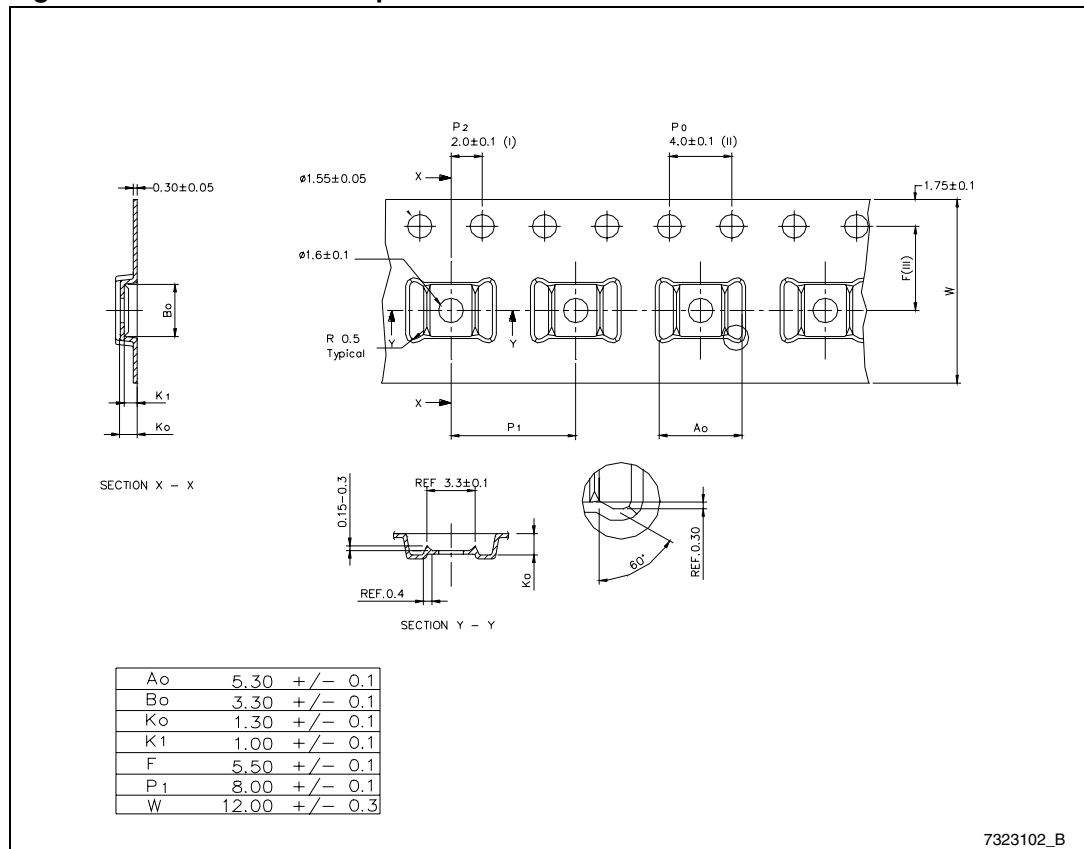

Figure 47. Reel information

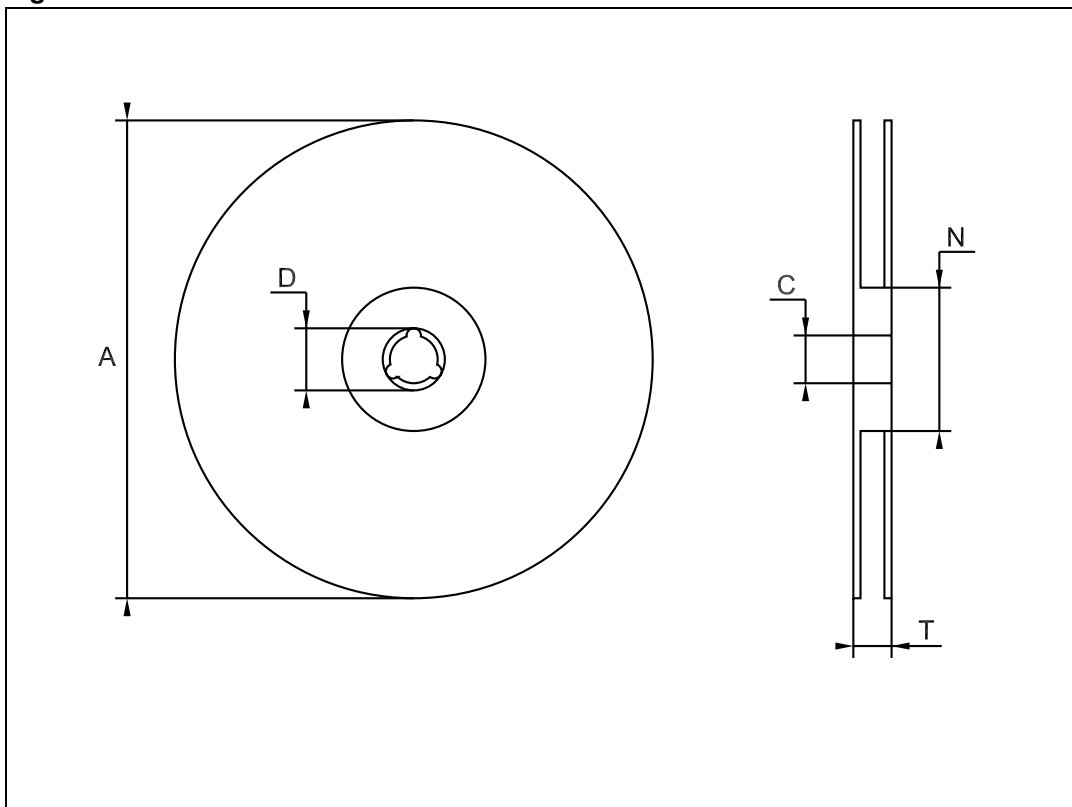

Table 14. Reel mechanical data

Symbol	Millimeters		
	Min	Typ	Max
A			330
C	12.8		13.2
D	20.2		
N	60		
T			22.4

9 Revision history

Table 15. Document revision history

Date	Revision	Changes
03-Dec-2008	1	Initial release.
18-Dec-2009	2	Modified: Table 6 , Table 7 and Table 9 .
19-Jan-2011	3	Added Section 6: Typical operating characteristics and Section 7: Application information ; minor textual changes.

Please Read Carefully:

Information in this document is provided solely in connection with ST products. STMicroelectronics NV and its subsidiaries ("ST") reserve the right to make changes, corrections, modifications or improvements, to this document, and the products and services described herein at any time, without notice.

All ST products are sold pursuant to ST's terms and conditions of sale.

Purchasers are solely responsible for the choice, selection and use of the ST products and services described herein, and ST assumes no liability whatsoever relating to the choice, selection or use of the ST products and services described herein.

No license, express or implied, by estoppel or otherwise, to any intellectual property rights is granted under this document. If any part of this document refers to any third party products or services it shall not be deemed a license grant by ST for the use of such third party products or services, or any intellectual property contained therein or considered as a warranty covering the use in any manner whatsoever of such third party products or services or any intellectual property contained therein.

UNLESS OTHERWISE SET FORTH IN ST'S TERMS AND CONDITIONS OF SALE ST DISCLAIMS ANY EXPRESS OR IMPLIED WARRANTY WITH RESPECT TO THE USE AND/OR SALE OF ST PRODUCTS INCLUDING WITHOUT LIMITATION IMPLIED WARRANTIES OF MERCHANTABILITY, FITNESS FOR A PARTICULAR PURPOSE (AND THEIR EQUIVALENTS UNDER THE LAWS OF ANY JURISDICTION), OR INFRINGEMENT OF ANY PATENT, COPYRIGHT OR OTHER INTELLECTUAL PROPERTY RIGHT.

UNLESS EXPRESSLY APPROVED IN WRITING BY AN AUTHORIZED ST REPRESENTATIVE, ST PRODUCTS ARE NOT RECOMMENDED, AUTHORIZED OR WARRANTED FOR USE IN MILITARY, AIR CRAFT, SPACE, LIFE SAVING, OR LIFE SUSTAINING APPLICATIONS, NOR IN PRODUCTS OR SYSTEMS WHERE FAILURE OR MALFUNCTION MAY RESULT IN PERSONAL INJURY, DEATH, OR SEVERE PROPERTY OR ENVIRONMENTAL DAMAGE. ST PRODUCTS WHICH ARE NOT SPECIFIED AS "AUTOMOTIVE GRADE" MAY ONLY BE USED IN AUTOMOTIVE APPLICATIONS AT USER'S OWN RISK.

Resale of ST products with provisions different from the statements and/or technical features set forth in this document shall immediately void any warranty granted by ST for the ST product or service described herein and shall not create or extend in any manner whatsoever, any liability of ST.

ST and the ST logo are trademarks or registered trademarks of ST in various countries.

Information in this document supersedes and replaces all information previously supplied.

The ST logo is a registered trademark of STMicroelectronics. All other names are the property of their respective owners.

© 2011 STMicroelectronics - All rights reserved

STMicroelectronics group of companies

Australia - Belgium - Brazil - Canada - China - Czech Republic - Finland - France - Germany - Hong Kong - India - Israel - Italy - Japan - Malaysia - Malta - Morocco - Philippines - Singapore - Spain - Sweden - Switzerland - United Kingdom - United States of America

www.st.com