

Pb Free Plating Product

FF60UP30DN



60.0 Ampere, 300 Volt Common Cathode Fast Recovery Epitaxial Diode

APPLICATION

- Freewheeling, Snubber, Clamp
- Inversion Welder
- PFC
- Plating Power Supply
- Ultrasonic Cleaner and Welder
- Converter & Chopper
- UPS

PRODUCT FEATURE

- Ultrafast Recovery Time
- Soft Recovery Characteristics
- Low Recovery Loss
- Low Forward Voltage
- High Surge Current Capability
- Low Leakage Current

TO-3PB/TO-3PN

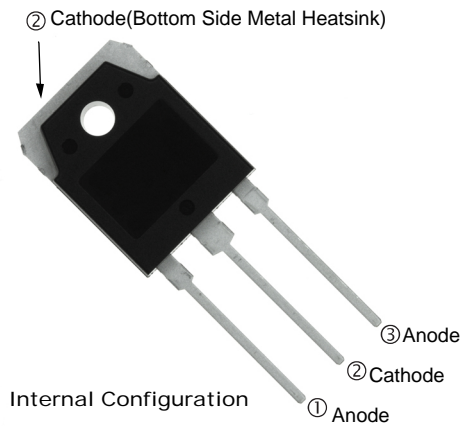

Internal Configuration

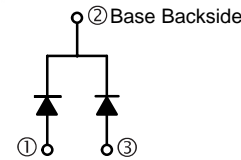

GENERAL DESCRIPTION

FF60UP30DN using the latest FRED FAB process(planar passivation chip) with ultrafast and soft recovery characteristic.

ABSOLUTE MAXIMUM RATINGS

$T_C=25^{\circ}\text{C}$ unless otherwise specified

Symbol	Parameter	Test Conditions	Values	Unit
V_R	Maximum D.C. Reverse Voltage		300	V
V_{RRM}	Maximum Repetitive Reverse Voltage		300	V
$I_{F(AV)}$	Average Forward Current	$T_C=110^{\circ}\text{C}$, Per Diode	30	A
		$T_C=110^{\circ}\text{C}$, Per Package	60	A
$I_{F(RMS)}$	RMS Forward Current	$T_C=110^{\circ}\text{C}$, Per Diode	42	A
I_{FSM}	Non-Repetitive Surge Forward Current	$T_J=45^{\circ}\text{C}$, $t=10\text{ms}$, 50Hz, Sine	480	A
P_D	Power Dissipation		156	W
T_J	Junction Temperature		-55to +150	$^{\circ}\text{C}$
T_{STG}	Storage Temperature Range		-55 to +150	$^{\circ}\text{C}$
Torque	Module-to-Sink	Recommended (M3)	1.1	N·m
$R_{th(J-C)}$	Thermal Resistance	Junction-to-Case, Per Diode	0.8	$^{\circ}\text{C}/\text{W}$
Weight			6	g

ELECTRICAL CHARACTERISTICS

$T_C=25^{\circ}\text{C}$ unless otherwise specified

Symbol	Parameter	Test Conditions	Min.	Typ.	Max.	Unit
I_{RM}	Reverse Leakage Current	$V_R=300\text{V}$	--	--	10	μA
		$V_R=300\text{V}$, $T_J=125^{\circ}\text{C}$	--	--	10	mA
V_F	Forward Voltage	$I_F=30\text{A}$	--	1.25	1.8	V
		$I_F=30\text{A}$, $T_J=125^{\circ}\text{C}$	--	1.12	--	V
t_{rr}	Reverse Recovery Time	$I_F=1\text{A}$, $V_R=30\text{V}$, $di_F/dt=-200\text{A}/\mu\text{s}$	--	22	--	ns
t_{rr}	Reverse Recovery Time	$V_R=150\text{V}$, $I_F=30\text{A}$	--	35	--	ns
I_{RRM}	Max. Reverse Recovery Current	$di_F/dt=-200\text{A}/\mu\text{s}$, $T_J=25^{\circ}\text{C}$	--	2.5	--	A
t_{rr}	Reverse Recovery Time	$V_R=150\text{V}$, $I_F=30\text{A}$	--	70	--	ns
I_{RRM}	Max. Reverse Recovery Current	$di_F/dt=-200\text{A}/\mu\text{s}$, $T_J=125^{\circ}\text{C}$	--	6.8	--	A

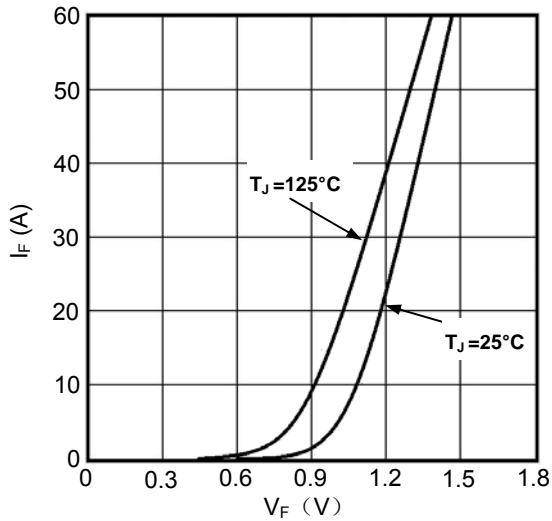

Fig1. Forward Voltage Drop vs Forward Current

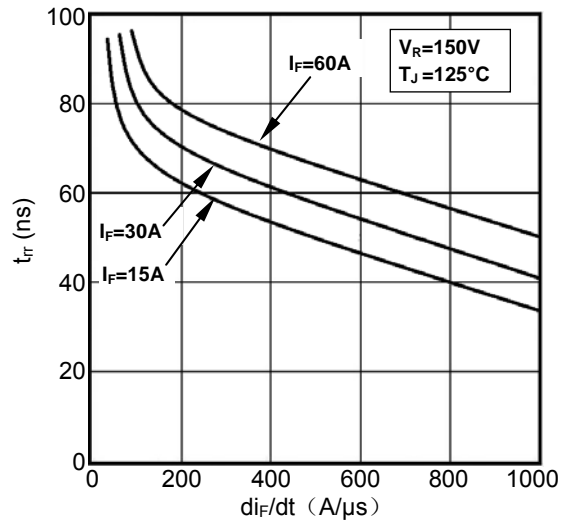

Fig2. Reverse Recovery Time vs di_F/dt

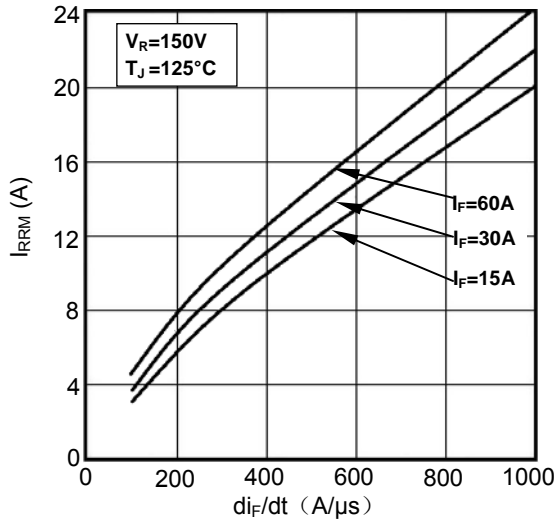

Fig3. Reverse Recovery Current vs di_F/dt

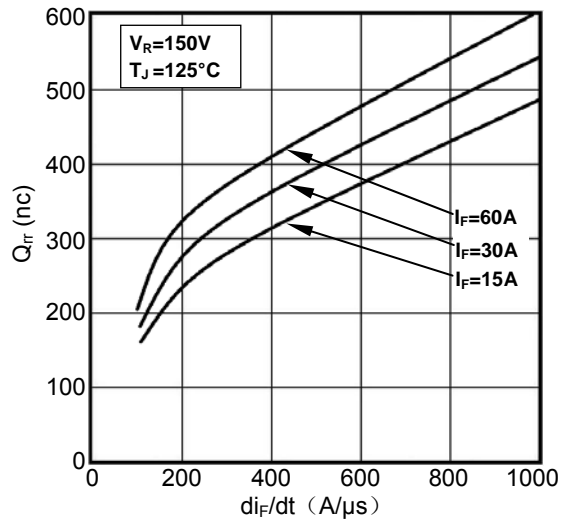

Fig4. Reverse Recovery Charge vs di_F/dt

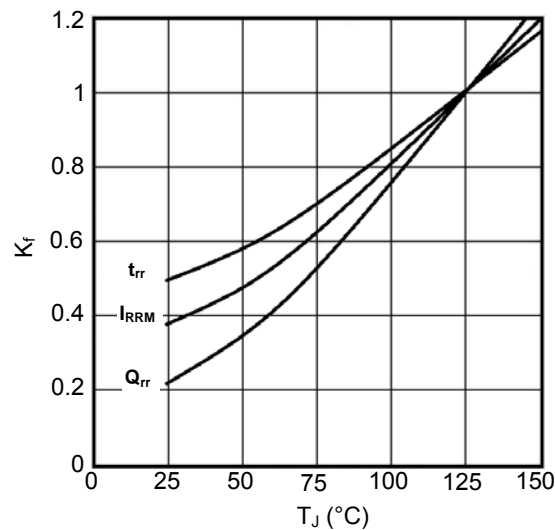

Fig5. Dynamic Parameters vs Junction Temperature

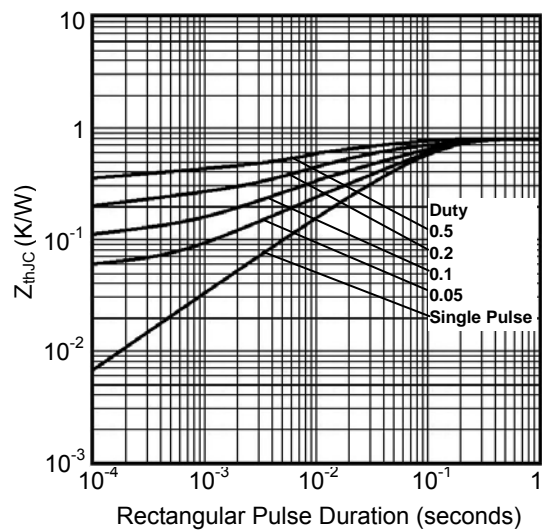

Fig6. Transient Thermal Impedance

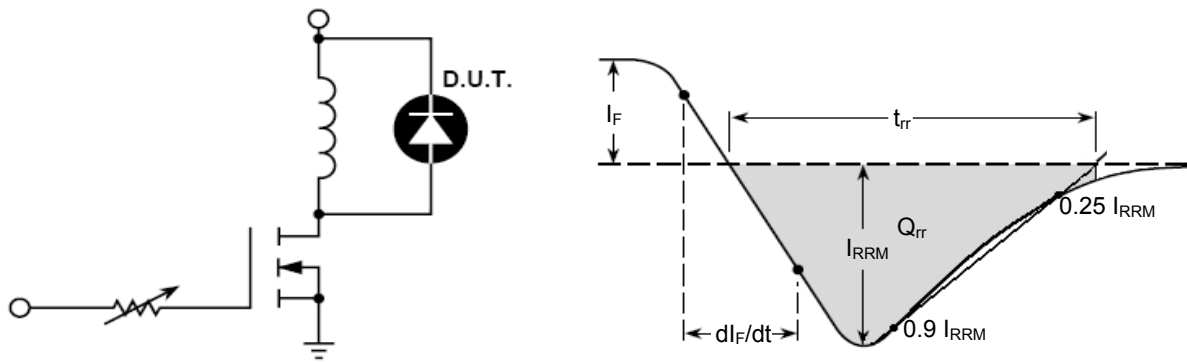
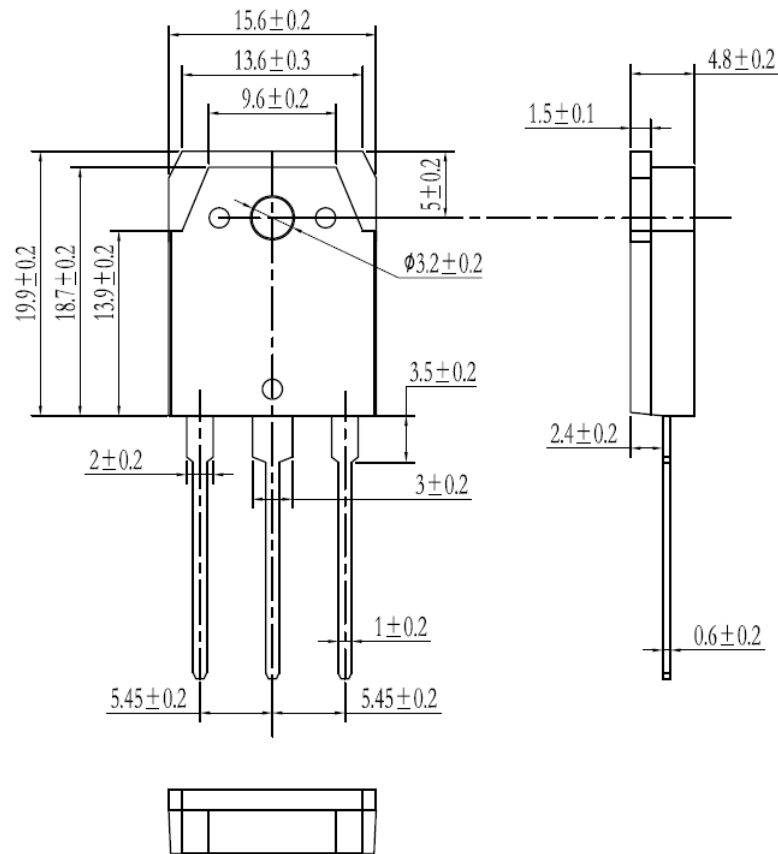

Fig7. Diode Reverse Recovery Test Circuit and Waveform



Dimensions in Millimeters
Fig8. Package Outline