

MABA-009836-CF48A0



4:1 Flux Coupled Transformer
5 - 200 MHz

M/A-COM Products
Rev. V1

Features

- Surface Mount
- 4:1 Impedance
- 260°C Reflow Compatible
- RoHS* Compliant, lead free
- Available on Tape and Reel.

Description

M/A-COM's MABA-009836-CF48A0 is a 4:1 RF flux coupled step up transformer in a low cost, surface mount package. Ideally suited for high volume CATV/Broadband applications.



Schematic

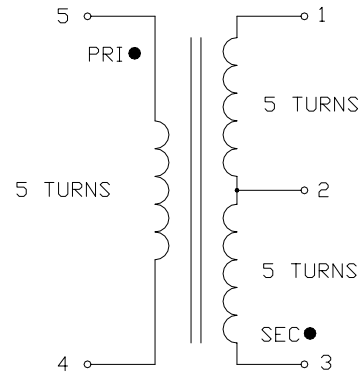

Case Style SM-138

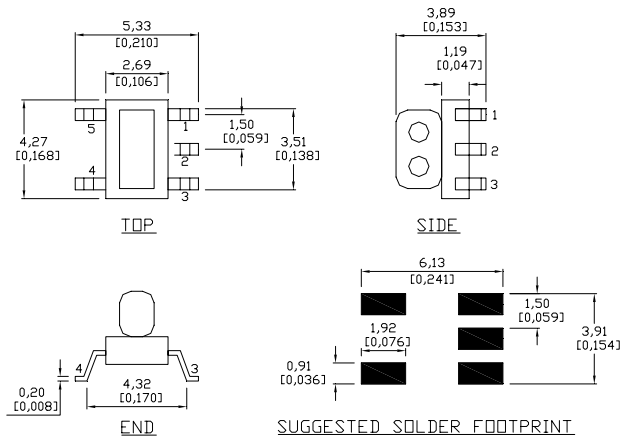

Pin Configuration

Pin No.	Function
1	Secondary
2	Secondary CT
3	Secondary Dot
4	Primary
5	Primary Dot

Dimensions are inches (millimeters) ± 0.015 (0.38) unless otherwise specified.

Ordering Information

Part Number	Package
MABA-009836-CF48A0	2000 piece reel
MABA-009836-CF48TB	Customer Test Board

Note: Reference Application Note **M513** for reel size information.

* Restrictions on Hazardous Substances, European Union Directive 2002/95/EC.

1

ADVANCED: Data Sheets contain information regarding a product M/A-COM is considering for development. Performance is based on target specifications, simulated results, and/or prototype measurements. Commitment to develop is not guaranteed.

PRELIMINARY: Data Sheets contain information regarding a product M/A-COM has under development. Performance is based on engineering tests. Specifications are typical. Mechanical outline has been fixed. Engineering samples and/or test data may be available. Commitment to produce in volume is not guaranteed.

- **North America** Tel: 800.366.2266 / Fax: 978.366.2266
- **Europe** Tel: 44.1908.574.200 / Fax: 44.1908.574.300
- **Asia/Pacific** Tel: 81.44.844.8296 / Fax: 81.44.844.8298

Visit www.macom.com for additional data sheets and product information.

M/A-COM Inc. and its affiliates reserve the right to make changes to the product(s) or information contained herein without notice.

Electrical Specifications: $T_A = 25^\circ\text{C}$, 0dBm, $Z_0 = 50\Omega$

Parameter	Test Conditions	Units	Min	Typ	Max
Insertion Loss	5 - 65 MHz	dB	-	0.4	0.7
	65 - 200 MHz	dB	-	0.9	1.5
Amplitude Unbalance	5 - 65 MHz	dB	-	± 0.02	± 0.1
	65 - 200 MHz	dB	-	± 0.2	± 0.5
Phase Unbalance	5 - 65 MHz	$^\circ$	-	± 0.4	± 2.0
	65 - 200 MHz	$^\circ$	-	± 2.0	± 8.0
Input Return Loss	5 - 65 MHz	dB	15	22	-
	65 - 200 MHz	dB	7	11	-

Recommended Maximum Ratings

Parameter	Value
RF Power	50mW
Peak IF Current	200mA
Operating Temperature	-40°C to $+85^\circ\text{C}$
Storage Temperature	-40°C to $+85^\circ\text{C}$

Application Circuit

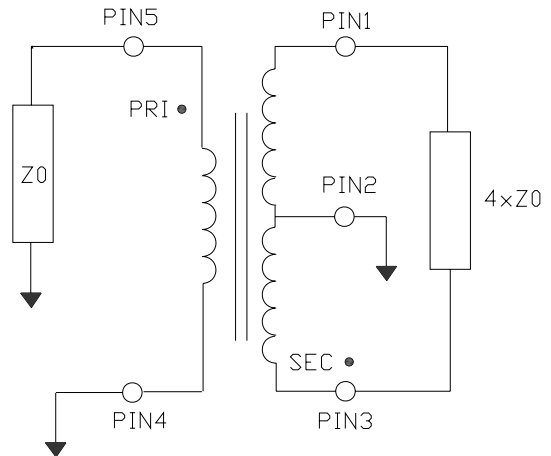

Typical Performance Curves: $T_A = 25^\circ\text{C}$, 0dBm, $Z_0 = 50\Omega$

Insertion Loss 1:

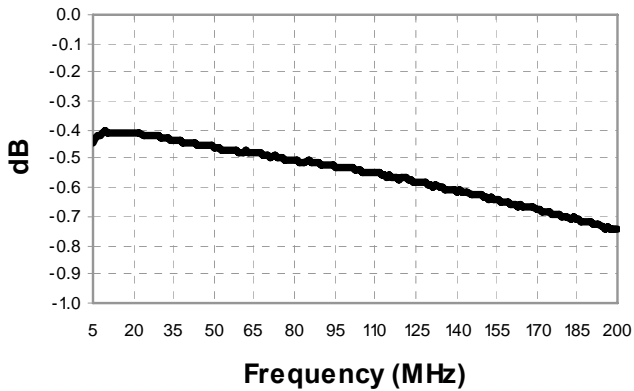

Insertion Loss 2:

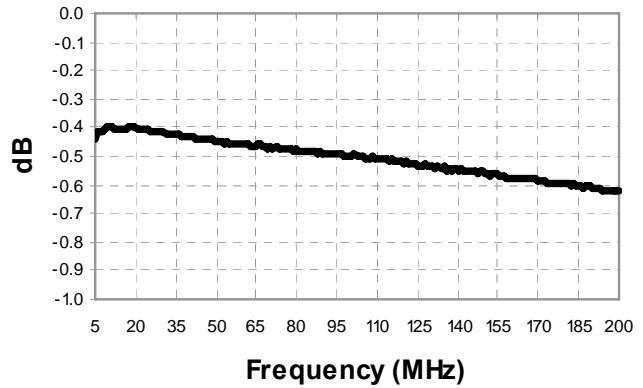

Amplitude Balance

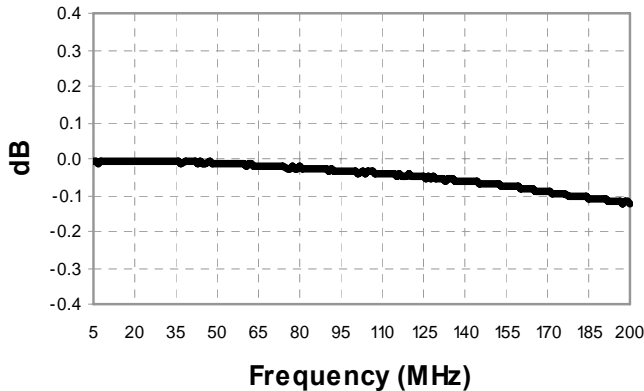

Phase Balance

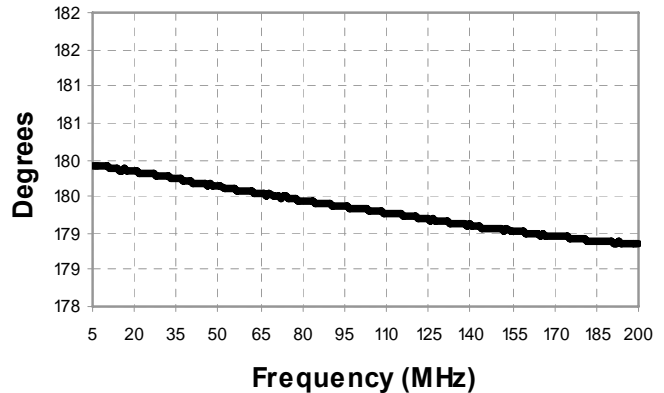

Return Loss: Input

