

**Dual 1.1MHz, 800mA Synchronous DC-DC Buck Converter****AP3422**

## General Description

The AP3422 contains two independent 1.1MHz fixed frequency, current mode, PWM synchronous buck (step-down) DC-DC converters, each of them is capable of driving a 800mA load with high efficiency, excellent line and load regulation. Each converter integrates a main switch and a synchronous switch without an external Schottky diode. It is ideal for powering portable equipment that runs from a single Li-ion battery.

A standard series of inductors are available from several different manufacturers optimized for use with the AP3422. This feature greatly simplifies the design of switch-mode power supplies.

This IC is available in DFN-3×3-10 package.

## Features

- High Efficiency: up to 95%
- Output Current on Each Channel: 800mA
- Input Voltage Range: 2.5V to 5.5V
- Fixed 1.1MHz Frequency
- 100% Duty Cycle in Dropout
- Built-in Short Circuit Protection
- Built-in Thermal Shutdown Function
- Built-in Current Limit Function
- Shutdown Current: <1 $\mu$ A

## Applications

- GPS
- WiFi Card
- Portable Media Player
- Digital Still and Video Cameras

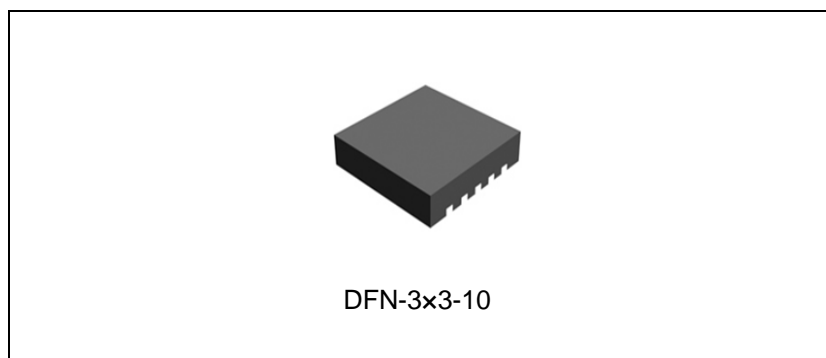

Figure 1. Package Type of AP3422

**Dual 1.1MHz, 800mA Synchronous DC-DC Buck Converter**
**AP3422**
**Pin Configuration**

 DN Package  
 (DFN-3x3-10)

Figure 2. Pin Configuration of AP3422 (Top View)

**Pin Description**

Pin Number	Pin Name	Function
1	EN1	Channel 1 enable control input. Drive EN1 above 1.5V to turn on the Channel 1. Drive EN1 below 0.6V to turn it off (shutdown current < 0.1 $\mu$ A)
2	FB1	Channel 1 feedback input. Connect FB1 to the center point of the external resistor divider. The feedback voltage is 0.6V
3	VIN2	Channel 2 supply input. Bypass to GND with a 10 $\mu$ F or greater ceramic capacitor
4	GND2	Ground 2
5	SW2	Channel 2 power switch output. Inductor connection to drains of the internal PFET and NFET switches
6	EN2	Channel 2 Enable Control Input. Drive EN2 above 1.5V to turn on the Channel 2. Drive EN2 below 0.6V to turn it off (shutdown current < 0.1 $\mu$ A)
7	FB2	Channel 2 feedback input. Connect FB2 to the center point of the external resistor divider. The feedback voltage is 0.6V
8	VIN1	Channel 1 supply input. Bypass to GND with a 10 $\mu$ F or greater ceramic capacitor
9	GND1	Ground 1
10	SW1	Channel 1 power switch output. Inductor connection to drains of the internal PFET and NFET switches

**Dual 1.1MHz, 800mA Synchronous DC-DC Buck Converter**

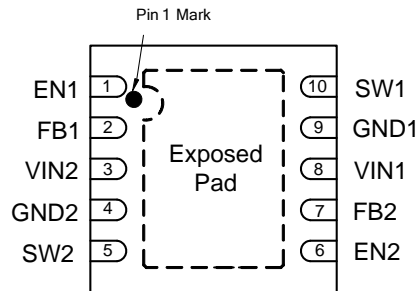
**AP3422**

**Functional Block Diagram**

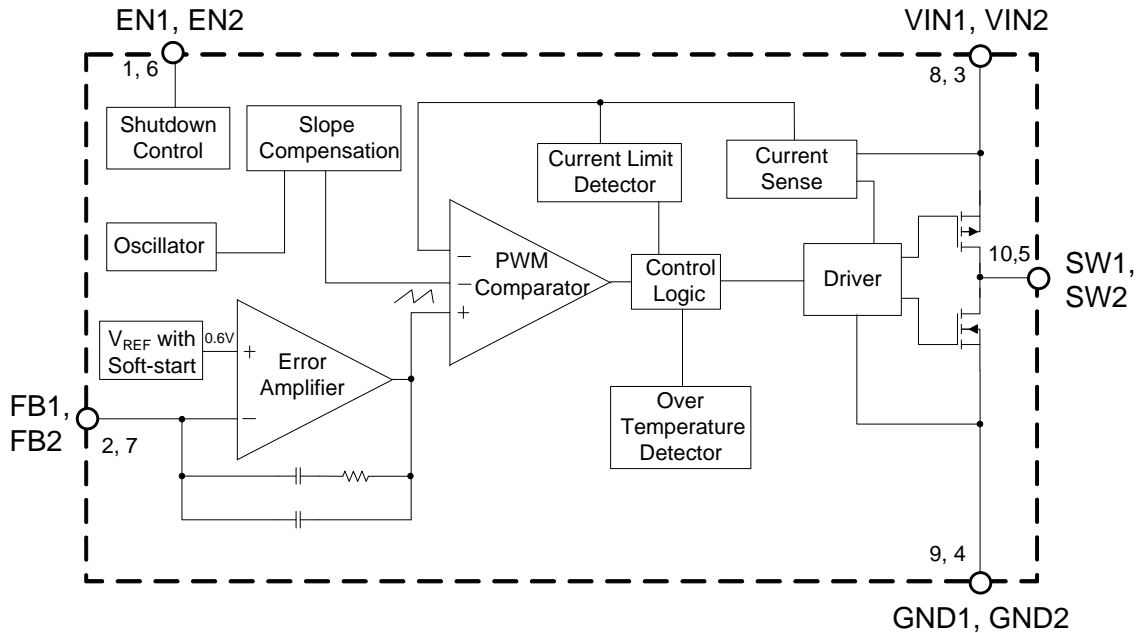
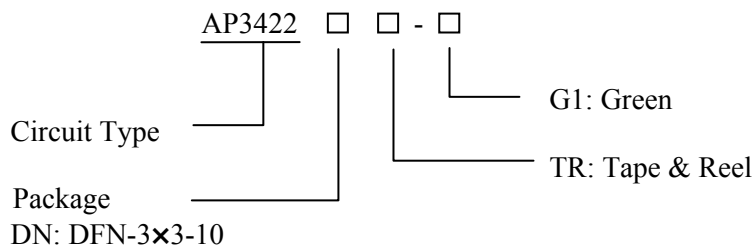

Figure 3. Functional Block Diagram of AP3422 (Diagram represents 1/2 of the AP3422)

**Ordering Information**



Package	Temperature Range	Part Number	Marking ID	Packing Type
DFN-3x3-10	-40 to 85 °C	AP3422DNTR-G1	BDC	Tape & Reel

BCD Semiconductor's Pb-free products, as designated with "G1" suffix in the part number, are RoHS compliant and green.

**Dual 1.1MHz, 800mA Synchronous DC-DC Buck Converter****AP3422****Absolute Maximum Ratings (Note 1)**

Parameter	Symbol	Value	Unit
Input Voltage	$V_{IN1}, V_{IN2}$	-0.3 to 6	V
Feedback Voltage	$V_{FB1}, V_{FB2}$	-0.3 to $V_{IN} + 0.3$	V
EN1, EN2 Pin Voltage	$V_{EN1}, V_{EN2}$	-0.3 to $V_{IN} + 0.3$	V
SW1, SW2 Pin Voltage	$V_{SW1}, V_{SW2}$	-0.3 to $V_{IN} + 0.3$	V
Thermal Resistance	$\theta_{JA}$	50	°C/W
Operating Junction Temperature	$T_J$	150	°C
Storage Temperature	$T_{STG}$	-65 to 150	°C
Lead Temperature (Soldering, 10sec)	$T_{LEAD}$	260	°C

Note 1: Stresses greater than those listed under “Absolute Maximum Ratings” may cause permanent damage to the device. These are stress ratings only, and functional operation of the device at these or any other conditions beyond those indicated under “Recommended Operating Conditions” is not implied. Exposure to “Absolute Maximum Ratings” for extended periods may affect device reliability.

**Recommended Operating Conditions**

Parameter	Symbol	Min	Max	Unit
Input Voltage	$V_{IN1}, V_{IN2}$	2.5	5.5	V
Maximum Output Current	$I_{OUT1 (MAX)},$ $I_{OUT2 (MAX)}$	800		mA
Operating Ambient Temperature	$T_A$	-40	85	°C



**Dual 1.1MHz, 800mA Synchronous DC-DC Buck Converter**

**AP3422**

**Electrical Characteristics**

$V_{IN1}=V_{IN2}=V_{EN1}=V_{EN2}=3.6V$ ,  $T_A=25^\circ C$ , unless otherwise specified. Specifications with **boldface type** apply over full operating temperature range from  $-40$  to  $85^\circ C$ .

Parameters	Symbol	Conditions	Min	Typ	Max	Unit
Supply Current on Each Converter	$I_{CC}$	$V_{FB}=0.55V$		400	600	$\mu A$
Shutdown Supply Current on Each Converter	$I_{SHDN}$	$V_{EN}=0V, V_{IN}=5.5V$		0.01	1	$\mu A$
Under Voltage Lockout Threshold	$V_{UVLO}$	Rising Edge		2.27		V
Under Voltage Lockout Hysteresis	$V_{HUVLO}$			200		mV
Feedback Bias Current	$I_{FB}$	$V_{FB}=0.65V$	-50	0.5	50	nA
Feedback Voltage	$V_{FB}$	$I_{OUT}=100mA$	0.588/ <b>0.582</b>	0.600	0.612/ <b>0.618</b>	V
Maximum Output Current	$I_{OUT(MAX)}$	$V_{IN}=2.5V,$ $V_{OUT}=0.9V$	800			mA
		$V_{IN}=3.6V,$ $V_{OUT}=1.2V$	800			
		$V_{IN}=4.6V,$ $V_{OUT}=3.3V$	800			
Switch Current Limit	$I_{LIM}$	$V_{FB}=0.55V$	0.95	1.25		A
Oscillator Frequency	$f_{OSC}$		0.8	1.1	1.4	MHz
EN Pin Threshold	$V_{ENL}$				0.6	V
	$V_{ENH}$		1.5			
EN Pin Input Leakage Current	$I_H$	$V_{EN}=3.6V$	-0.1		0.1	$\mu A$
	$I_L$	$V_{EN}=0V$	-0.1		0.1	$\mu A$
Internal PFET On Resistance	$R_{DSONP}$	$I_{SW}=100mA$		0.44		$\Omega$
Internal NFET On Resistance	$R_{DSONN}$	$I_{SW}=-100mA$		0.29		$\Omega$
Maximum Duty Cycle	$D_{MAX}$	$V_{FB}=0.55V$		100		%
Soft-start Time	$T_{SS}$	$V_{EN}=0V$ to $V_{IN}$ $I_{OUT}=50mA$		220		$\mu s$
Thermal Shutdown Threshold	$T_{OTSD}$			160		$^\circ C$
Thermal Shutdown Hysteresis	$T_{HYS}$			30		$^\circ C$



Dual 1.1MHz, 800mA Synchronous DC-DC Buck Converter

AP3422

Typical Performance Characteristics

$L1=L2=10\mu\text{H}$ ,  $C_{IN1}=C_{IN2}=C_{OUT1}=C_{OUT2}=10\mu\text{F}$ ,  $T_A=25^\circ\text{C}$ , unless otherwise noted.

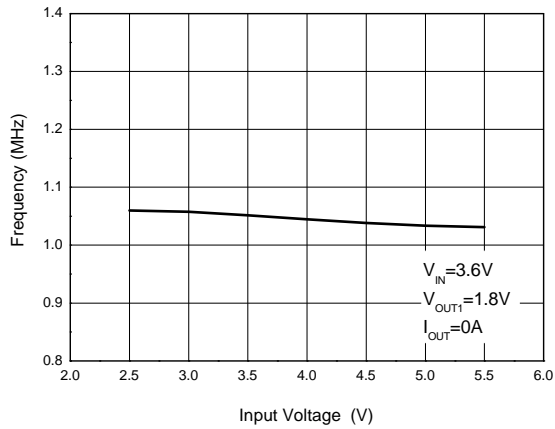

Figure 4. Frequency vs. Input Voltage

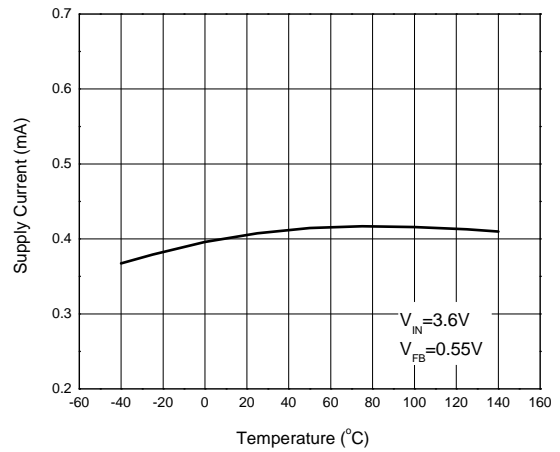

Figure 5. Supply Current vs. Temperature

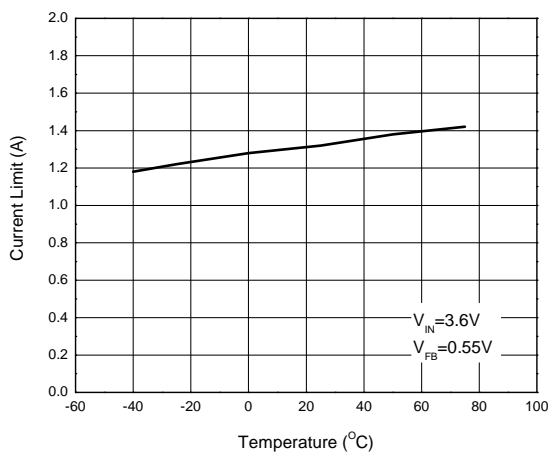

Figure 6. Current Limit vs. Temperature

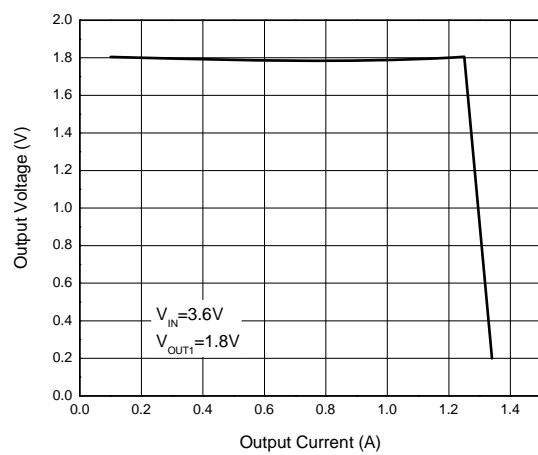

Figure 7. Output Voltage vs. Output Current

**Typical Performance Characteristics (Continued)**

$L_1=L_2=10\mu\text{H}$ ,  $C_{IN1}=C_{IN2}=C_{OUT1}=C_{OUT2}=10\mu\text{F}$ ,  $T_A=25^\circ\text{C}$ , unless otherwise noted.

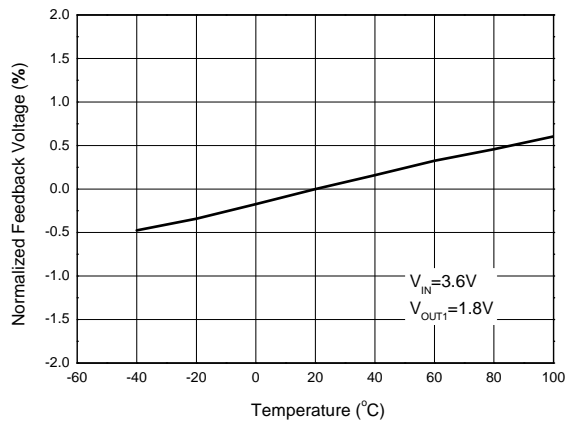

Figure 8. Normalized Feedback Voltage vs. Temperature

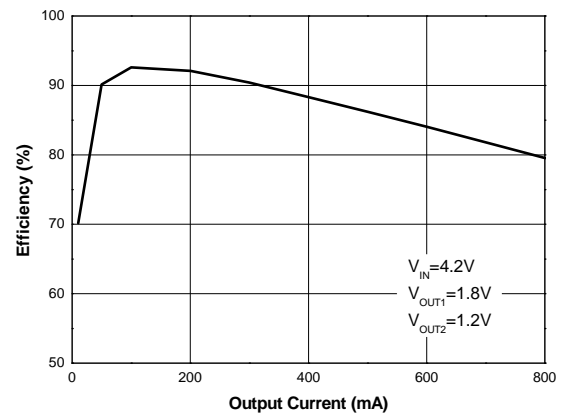
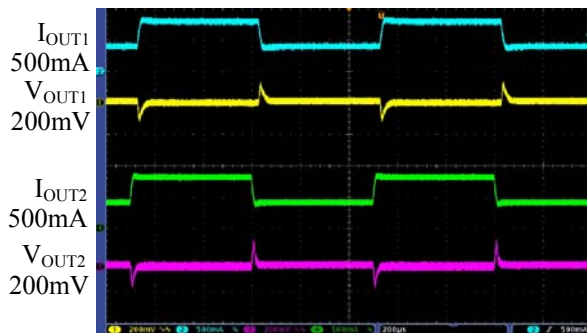
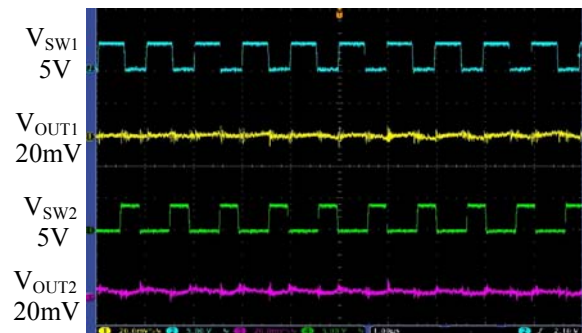

Figure 9. Efficiency vs. Output Current



Time 200µs/div

 Figure 10. Load Transient ( $V_{IN}=4.2\text{V}$ ,  $V_{OUT1}=1.8\text{V}$ ,  $V_{OUT2}=1.2\text{V}$ ,  $I_{OUT1}=400\text{mA}$  to  $800\text{mA}$ ,  $I_{OUT2}=400$  to  $800\text{mA}$ )

Time 1µs/div

 Figure 11. Heavy Load Operation ( $V_{IN}=4.2\text{V}$ ,  $V_{OUT1}=1.8\text{V}$ ,  $V_{OUT2}=1.2\text{V}$ ,  $I_{OUT1}=I_{OUT2}=800\text{mA}$ )

**Typical Performance Characteristics (Continued)**

$L_1=L_2=10\mu\text{H}$ ,  $C_{IN1}=C_{IN2}=C_{OUT1}=C_{OUT2}=10\mu\text{F}$ ,  $T_A=25\text{ }^\circ\text{C}$ , unless otherwise noted.

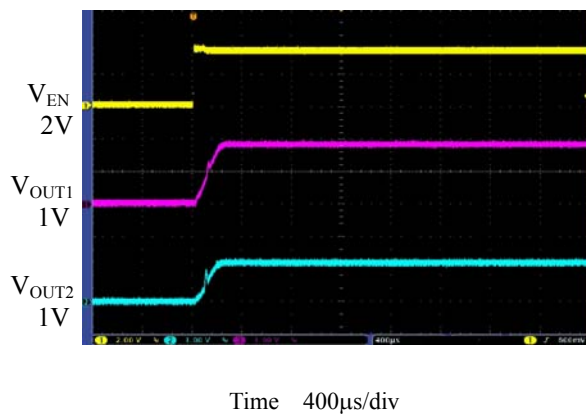

Figure 12. Start-up from Shutdown ( $V_{IN}=4.2\text{V}$ ,  $V_{OUT1}=1.8\text{V}$ ,  $V_{OUT2}=1.2\text{V}$ ,  $V_{EN}=0$  to  $3.6\text{V}$ ,  $I_{OUT1}=I_{OUT2}=400\text{mA}$ )



### Typical Application

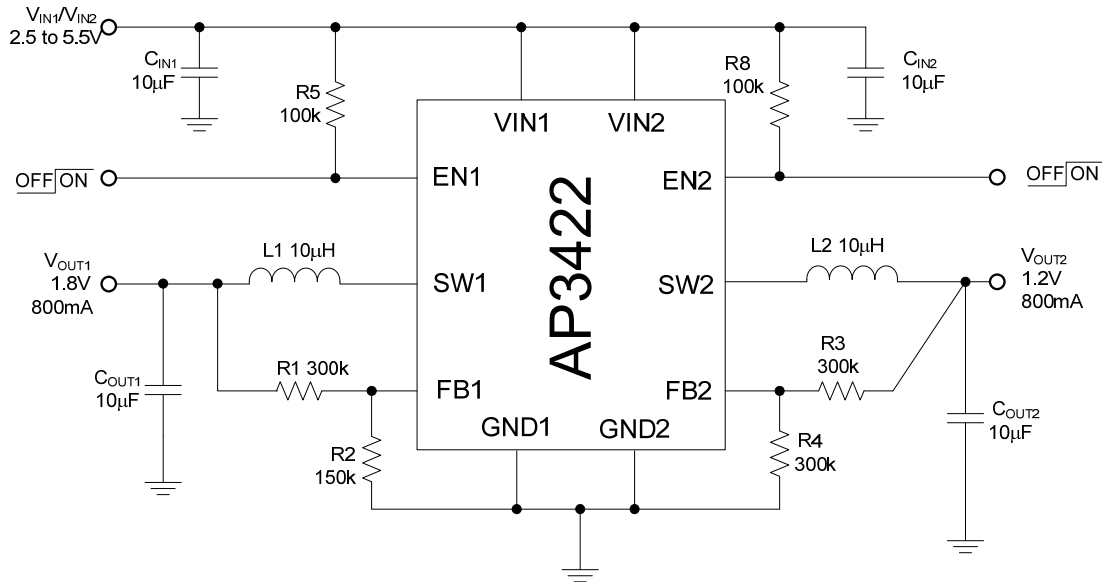

Figure 13. Typical Application of AP3422



Dual 1.1MHz, 800mA Synchronous DC-DC Buck Converter

AP3422

Mechanical Dimensions

DFN-3x3-10

Unit:mm(inch)

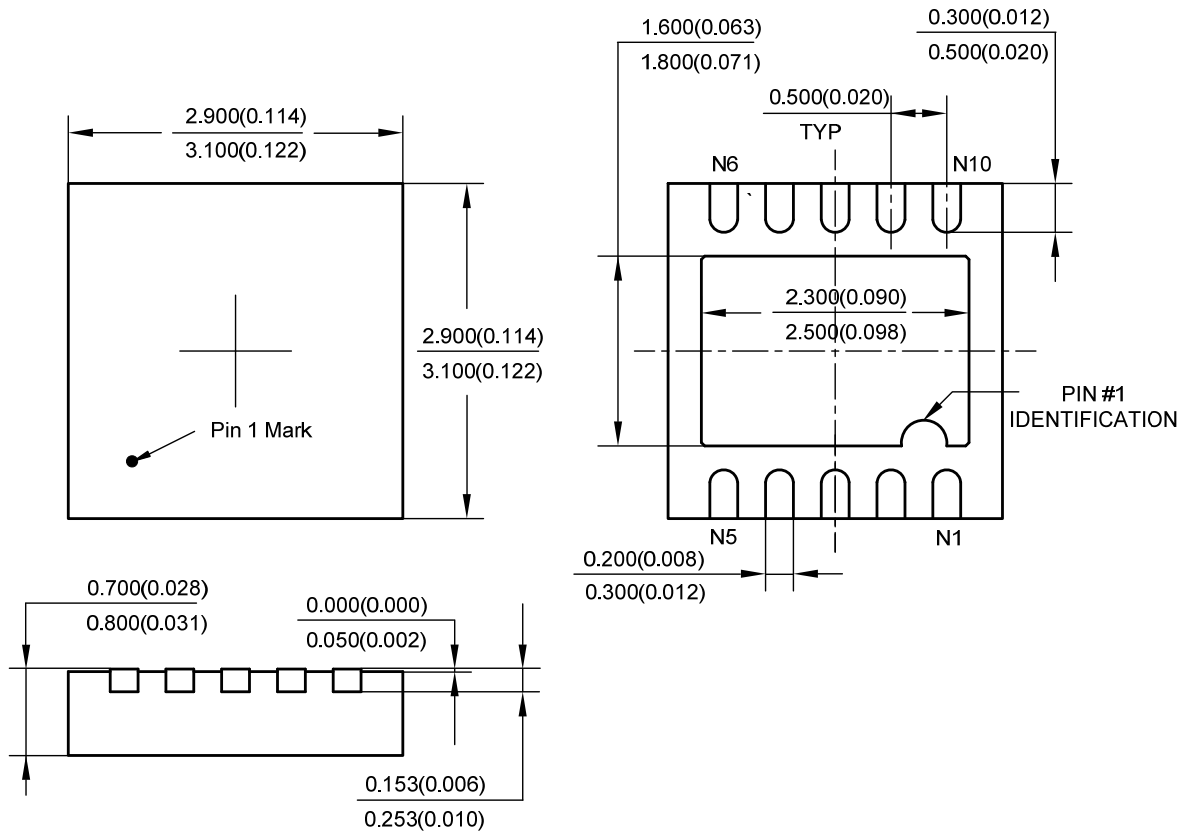



## BCD Semiconductor Manufacturing Limited

<http://www.bcdsemi.com>

### IMPORTANT NOTICE

BCD Semiconductor Manufacturing Limited reserves the right to make changes without further notice to any products or specifications herein. BCD Semiconductor Manufacturing Limited does not assume any responsibility for use of any its products for any particular purpose, nor does BCD Semiconductor Manufacturing Limited assume any liability arising out of the application or use of any its products or circuits. BCD Semiconductor Manufacturing Limited does not convey any license under its patent rights or other rights nor the rights of others.

---

#### MAIN SITE

##### - Headquarters

##### BCD Semiconductor Manufacturing Limited

No. 1600, Zi Xing Road, Shanghai ZiZhu Science-based Industrial Park, 200241, China  
Tel: +86-21-24162266, Fax: +86-21-24162277

##### - Wafer Fab

##### Shanghai SIM-BCD Semiconductor Manufacturing Co., Ltd.

800 Yi Shan Road, Shanghai 200233, China  
Tel: +86-21-6485 1491, Fax: +86-21-5450 0008

#### REGIONAL SALES OFFICE

##### Shenzhen Office

##### Shanghai SIM-BCD Semiconductor Manufacturing Co., Ltd., Shenzhen Office

Unit A Room 1203, Skyworth Bldg., Gaoxin Ave. 1.S., Nanshan District, Shenzhen, China  
Tel: +86-755-8826 7951  
Fax: +86-755-8826 7865

##### Taiwan Office

##### BCD Semiconductor (Taiwan) Company Limited

4F, 298-1, Rui Guang Road, Nei-Hu District, Taipei, Taiwan  
Tel: +886-2-2656 2808  
Fax: +886-2-2656 2806

##### USA Office

##### BCD Semiconductor Corp.

30920 Huntwood Ave. Hayward, CA 94544, USA  
Tel : +1-510-324-2988  
Fax: +1-510-324-2788