

## Description

AP22966 is an integrated dual N-channel load switch which features an adjustable slew rate that can be set using an external capacitor independently for each channel. The N-Channel MOSFETs have a typical  $R_{ON}$  of 18m $\Omega$ , enabling current handling capability of up to 6A. Both channels can independently be controlled with low voltage logic signals.

AP22966 is designed to operate from 0.8V to 5.5V. The low quiescent supply current makes it ideal for use in battery powered distribution systems where power consumption is a concern.

AP22966 is available in a standard Green V-DFN3020-14 package with exposed PAD for improved thermal performance and is RoHS compliant.

## Features

- Integrated Dual Channel Load Switch
- 0.8V to 5.5V Input Voltage Range
- Low Typical  $R_{ON}$  of 18m $\Omega$  ( $V_{BIAS} = 5V$ )
- 6A Maximum Continuous Current per Channel
- Very Low Quiescent Current
  - 60 $\mu$ A (Both Channels)
  - 45 $\mu$ A (Single Channel)
- Per Channel Adjustable Slew Rate
- Internal Quick Output Discharge (QOD)
- Low Voltage Logic Enable
  - 1.2/1.8/2.5/3.3V Logic
- Small Form Factor Package V-DFN3020-14 – footprint of just 6mm<sup>2</sup>
- Thermally Efficient Low Profile Package
- **Totally Lead-Free & Fully RoHS Compliant (Notes 1 & 2)**
- **Halogen and Antimony Free. "Green" Device (Note 3)**

- Notes:
1. No purposely added lead. Fully EU Directive 2002/95/EC (RoHS) & 2011/65/EU (RoHS 2) compliant.
  2. See [http://www.diodes.com/quality/lead\\_free.html](http://www.diodes.com/quality/lead_free.html) for more information about Diodes Incorporated's definitions of Halogen- and Antimony-free, "Green" and Lead-free.
  3. Halogen- and Antimony-free "Green" products are defined as those which contain <900ppm bromine, <900ppm chlorine (<1500ppm total Br + Cl) and <1000ppm antimony compounds.

## Pin Assignments

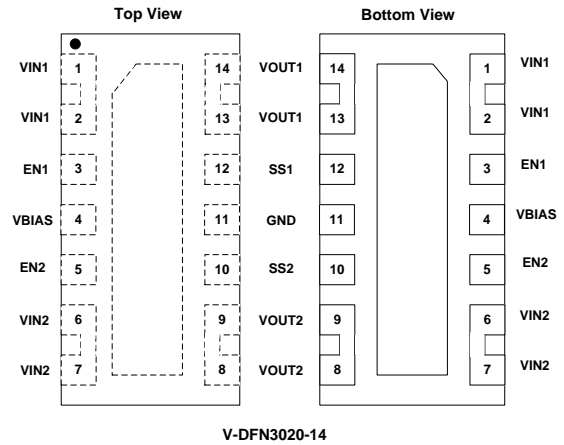

## Applications

- Ultrabooks
- Notebooks
- Netbooks
- SetTop Boxes
- SSD (Solid State Drives)
- Consumer Electronics
- Tablet PC
- Telecom Systems

## Typical Applications Circuit

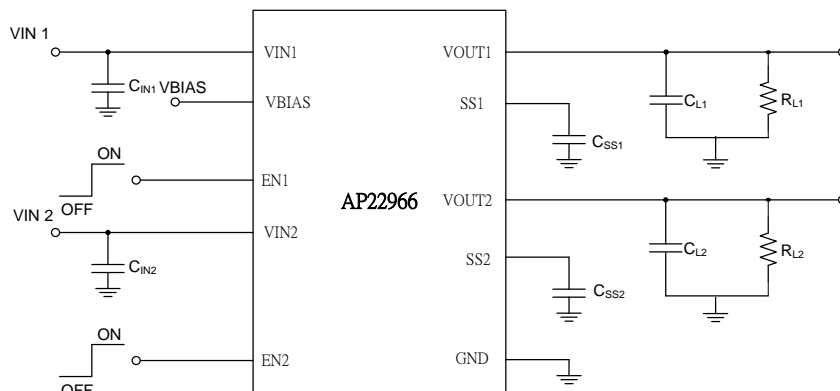

### Pin Descriptions

Pin Name	Pin Number	Function
VIN1	1, 2	Channel 1 input. Recommended voltage range for this pin for optimal $R_{ON}$ performance from 0.8V to $V_{BIAS}$ . Place an optional decoupling capacitor between this pin and GND for reduce $V_{IN}$ dip during turn on.
EN1	3	Active High Channel 1 enable input
VBIAS	4	$V_{BIAS}$ Voltage. Recommended voltage range from 2.5V to 5.5V.
EN2	5	Active High Channel 2 enable input
VIN2	6, 7	Channel 2 input. Recommended voltage range for this pin for optimal $R_{ON}$ performance from 0.8V to $V_{BIAS}$ . Place an optional decoupling capacitor between this pin and GND for reduce $V_{IN}$ dip during turn on.
VOUT2	8, 9	Channel 2 output This pin connects to the Source of the 2 <sup>nd</sup> N-channel MOSFET.
SS2	10	Channel 2 slew rate control An external capacitor connected to this pin will set the ramp-up time for Channel 2 output.
GND	11/PAD	Ground Connect Pin 11 and PAD together to system ground.
SS1	12	Channel 1 slew rate control An external capacitor connected to this pin will set the ramp-up time for Channel 1 output.
VOUT1	13, 14	Channel 1 output This pin connects to the Source of the 1 <sup>st</sup> N-channel MOSFET

### Functional Block Diagram

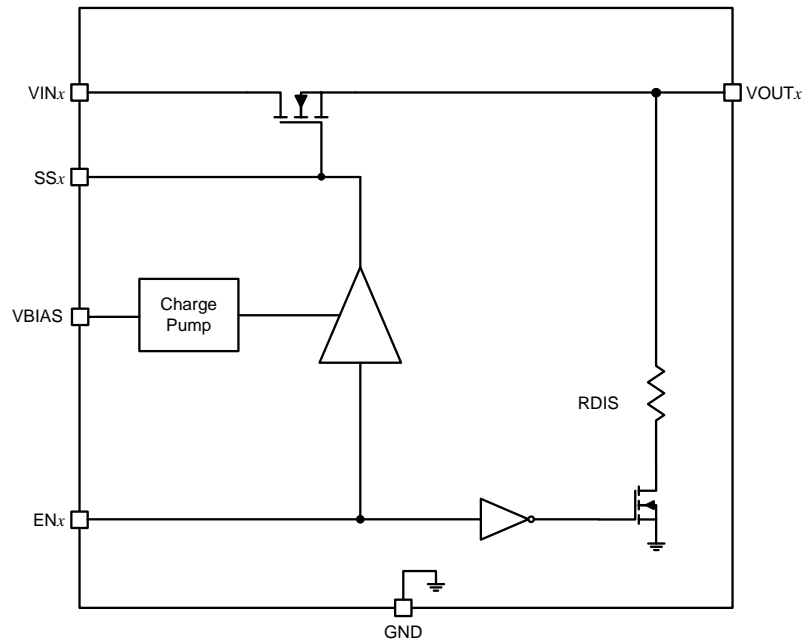

where  $x$  is the channel number (1 or 2)

### Absolute Maximum Ratings (@ $T_A = +25^\circ\text{C}$ , unless otherwise specified.) (Note 4)

Symbol	Parameter	Ratings	Units
ESD HBM	Human Body ESD Protection	4000	V
ESD MM	Machine Model ESD Protection	300	V
ESD CDM	Charged Device Model ESD Protection	1000	V
$V_{IN}$	Input Voltage at VIN1, VIN2 Pin	-0.3 to +6	V
$V_{BIAS}$	Bias Supply Voltage	-0.3 to +6	V
$V_{OUT}$	Output Voltage at VOUT1, VOUT2 Pin	-0.3 to +6	V
$V_{EN}$	Enable Voltage at EN1, EN2 Pin	-0.3 to +6	V
$I_L$	Load Current per channel	6	A
$I_{PLS}$	Maximum pulsed switch current per channel, pulse <math><300\mu\text{s}</math>, 2% duty cycle	8	A
$T_{J(max)}$	Maximum Junction Temperature	+125	$^\circ\text{C}$
$T_{ST}$	Storage Temperature	-65 to +150	$^\circ\text{C}$
$P_D$	Power Dissipation	(Note 5) V-DFN3020-14 2.7	W
$R_{\theta JA}$	Thermal Resistance, Junction to Ambient	(Note 5) V-DFN3020-14 46.5	$^\circ\text{C/W}$
		(Note 5) V-DFN3020-14 8	
$R_{\theta JL}$	Thermal Resistance, Junction to Leads	(Note 6) V-DFN3020-14 300	$^\circ\text{C/W}$

- Notes:
- Stresses greater than the 'Absolute Maximum Ratings' specified above may cause permanent damage to the device. These are stress ratings only; functional operation of the device at these or any other conditions exceeding those indicated in this specification is not implied. Device reliability may be affected by exposure to absolute maximum rating conditions for extended periods of time.
  - Device mounted on 2"x2" FR-4 substrate PCB, 2oz copper, with minimum recommended pad layout
  - Thermal resistance from junction to solder-point

### Recommended Operating Conditions (For each channel)

Symbol	Parameter	Min	Max	Units
$V_{IN}$	Input Voltage Range at VIN1, VIN2 Pin	0.8	$V_{BIAS}$	V
$V_{BIAS}$	Bias Supply Voltage Range	2.5	5.5	V
$V_{EN}$	Enable Voltage Range at EN1, EN2 Pin	0	5.5	V
$V_{OUT}$	Output Voltage at VOUT1, VOUT2 Pin	-	$V_{IN}$	V
$T_A$	Operating Ambient Temperature	-40	+85	$^\circ\text{C}$
$C_{IN}$	Input Capacitor	1	-	$\mu\text{F}$
$V_{IH\_EN}$	EN Input Logic High Voltage	1.2	5.5	V
$V_{IL\_EN}$	EN Input Logic Low Voltage	0	0.5	V

**Electrical Characteristics** (For each channel @  $T_A = -40^{\circ}\text{C}$  to  $+85^{\circ}\text{C}$ ,  $V_{IN} = 0.8\text{V}$  to  $5.5\text{V}$ ,  $V_{BIAS} = 5\text{V}$ ,  $C_{IN} = 1\mu\text{F}$ ,  $C_L = 100\text{nF}$ , typical values are at  $T_A = +25^{\circ}\text{C}$ , unless otherwise specified.)

Symbol	Parameters	Conditions	Min	Typ	Max	Unit	
I <sub>BIAS_Q</sub>	VBIAS Quiescent Current (both channels)	$V_{EN} = V_{IN} = V_{BIAS} = 5\text{V}$ , $I_{OUT} = 0\text{A}$	-	60	110	$\mu\text{A}$	
I <sub>BIAS_Q</sub>	VBIAS Quiescent Current (single channels)	$V_{EN1} = V_{IN} = V_{BIAS} = 5\text{V}$ , $V_{EN2} = 0\text{V}$ , $I_{OUT} = 0\text{A}$	-	45	-	$\mu\text{A}$	
I <sub>BIAS_OFF</sub>	VBIAS Off Supply Current	$V_{EN} = 0\text{V}$ , $V_{OUT} = 0\text{V}$	-	-	2	$\mu\text{A}$	
I <sub>IN_SD</sub>	Input Shutdown Current (per channel)	$V_{EN} = 0\text{V}$ $V_{OUT} = 0\text{V}$	$V_{IN} = 5\text{V}$	-	0.5	17	$\mu\text{A}$
			$V_{IN} = 3.3\text{V}$	-	0.1	6	$\mu\text{A}$
			$V_{IN} = 1.8\text{V}$	-	0.07	3	$\mu\text{A}$
			$V_{IN} = 0.8\text{V}$	-	0.04	2	$\mu\text{A}$
R <sub>ON</sub>	Load Switch On-Resistance	$V_{EN} = V_{BIAS}$ , $I_{OUT} = 200\text{mA}$ $T_A = +25^{\circ}\text{C}$	$V_{IN} = 5\text{V}$	-	17	24	m $\Omega$
			$V_{IN} = 3.3\text{V}$	-	17	24	m $\Omega$
			$V_{IN} = 1.8\text{V}$	-	17	24	m $\Omega$
			$V_{IN} = 1.5\text{V}$	-	17	24	m $\Omega$
			$V_{IN} = 1.2\text{V}$	-	17	24	m $\Omega$
R <sub>ON</sub>	Load Switch On-Resistance	$V_{EN} = V_{BIAS}$ , $I_{OUT} = 200\text{mA}$ $T_A = -40^{\circ}\text{C}$ to $+85^{\circ}\text{C}$	$V_{IN} = 5\text{V}$	-	-	26	m $\Omega$
			$V_{IN} = 3.3\text{V}$	-	-	26	m $\Omega$
			$V_{IN} = 1.8\text{V}$	-	-	26	m $\Omega$
			$V_{IN} = 1.5\text{V}$	-	-	26	m $\Omega$
			$V_{IN} = 1.2\text{V}$	-	-	26	m $\Omega$
			$V_{IN} = 0.8\text{V}$	-	-	26	m $\Omega$
I <sub>LEAK_EN</sub>	EN Input Leakage	$V_{EN} = 5.5\text{V}$	-	-	1	$\mu\text{A}$	
R <sub>DIS</sub>	Discharge FET On-Resistance	$V_{EN} = 0\text{V}$ , $I_{DIS} = 10\text{mA}$ , $T_A = +25^{\circ}\text{C}$	-	220	300	$\Omega$	

**Electrical Characteristics** (For each channel @  $T_A = -40^{\circ}\text{C}$  to  $+85^{\circ}\text{C}$ ,  $V_{IN} = 0.8\text{V}$  to  $5.5\text{V}$ ,  $V_{BIAS} = 2.5\text{V}$ ,  $C_{IN} = 1\mu\text{F}$ ,  $C_L = 100\text{nF}$ , typical values are at  $T_A = +25^{\circ}\text{C}$ , unless otherwise specified.)

Symbol	Parameters	Conditions	Min	Typ	Max	Unit	
I <sub>BIAS_Q</sub>	VBIAS Quiescent Current (both channels)	$V_{EN} = V_{IN} = V_{BIAS} = 2.5\text{V}$ , $I_{OUT} = 0\text{A}$	-	28	46	$\mu\text{A}$	
I <sub>BIAS_Q</sub>	VBIAS Quiescent Current (single channels)	$V_{EN1} = V_{IN} = V_{BIAS} = 2.5\text{V}$ , $V_{EN2} = 0\text{V}$ , $I_{OUT} = 0\text{A}$	-	20	-	$\mu\text{A}$	
I <sub>BIAS_OFF</sub>	VBIAS Off Supply Current	$V_{EN} = 0\text{V}$ , $V_{OUT} = 0\text{V}$	-	-	2	$\mu\text{A}$	
I <sub>IN_SD</sub>	Input Shutdown Current	$V_{EN} = 0\text{V}$ $V_{OUT} = 0\text{V}$	$V_{IN} = 2.5\text{V}$	-	0.13	4	$\mu\text{A}$
			$V_{IN} = 1.8\text{V}$	-	0.07	3	$\mu\text{A}$
			$V_{IN} = 1.2\text{V}$	-	0.05	2	$\mu\text{A}$
			$V_{IN} = 0.8\text{V}$	-	0.04	2	$\mu\text{A}$
R <sub>ON</sub>	Load Switch On-Resistance	$V_{EN} = V_{BIAS}$ , $I_{OUT} = 200\text{mA}$ $T_A = +25^{\circ}\text{C}$	$V_{IN} = 2.5\text{V}$	-	19	25	m $\Omega$
			$V_{IN} = 1.8\text{V}$	-	18	25	m $\Omega$
			$V_{IN} = 1.5\text{V}$	-	18	25	m $\Omega$
			$V_{IN} = 1.2\text{V}$	-	18	25	m $\Omega$
			$V_{IN} = 0.8\text{V}$	-	18	25	m $\Omega$
R <sub>ON</sub>	Load Switch On-Resistance	$V_{EN} = V_{BIAS}$ , $I_{OUT} = 200\text{mA}$ $T_A = -40^{\circ}\text{C}$ to $+85^{\circ}\text{C}$	$V_{IN} = 2.5\text{V}$	-	-	27	m $\Omega$
			$V_{IN} = 1.8\text{V}$	-	-	27	m $\Omega$
			$V_{IN} = 1.5\text{V}$	-	-	27	m $\Omega$
			$V_{IN} = 1.2\text{V}$	-	-	27	m $\Omega$
			$V_{IN} = 0.8\text{V}$	-	-	27	m $\Omega$
I <sub>LEAK_EN</sub>	EN Input Leakage	$V_{EN} = 5.5\text{V}$	-	-	1	$\mu\text{A}$	
R <sub>DIS</sub>	Discharge FET On-Resistance	$V_{EN} = 0\text{V}$ , $I_{DIS} = 10\text{mA}$ , $T_A = +25^{\circ}\text{C}$	-	220	300	$\Omega$	

**Test Circuit and  $t_{ON}/t_{OFF}$  Waveforms**

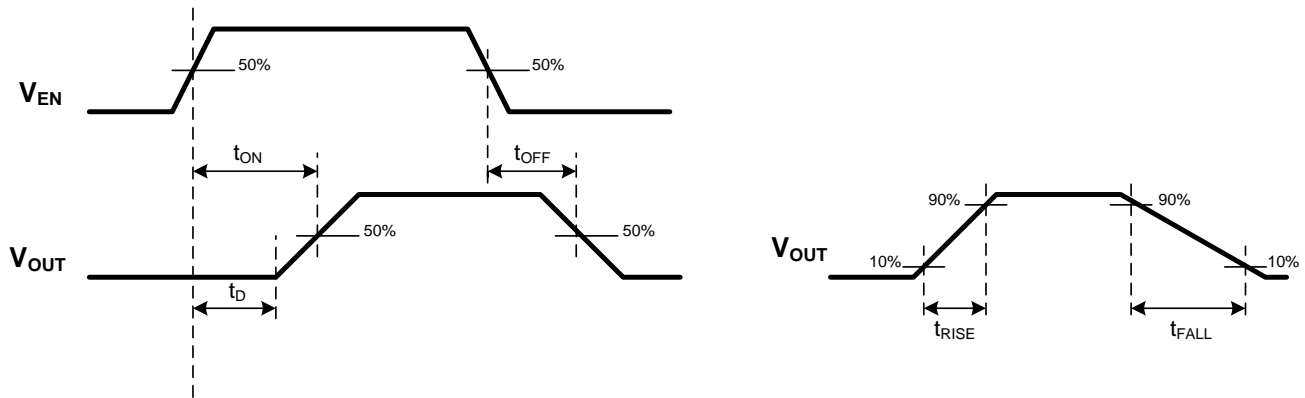

NEW PRODUCT

**Switching Characteristics**

Symbol	Parameters	Conditions	Min	Typ	Max	Unit
<b><math>V_{IN} = V_{EN} = V_{BIAS} = 5V, T_A = +25^{\circ}C</math></b>						
$t_{RISE}$	Output Rise-time	$R_L = 10\Omega, C_{SS} = 1000pF, C_L = 0.1\mu F$	-	1720	-	$\mu s$
$t_{ON}$	Output Turn-ON Delay Time	$R_L = 10\Omega, C_{SS} = 1000pF, C_L = 0.1\mu F$	-	1270	-	$\mu s$
$t_{FALL}$	Output Fall-time	$R_L = 10\Omega, C_{SS} = 1000pF, C_L = 0.1\mu F$	-	2.3	-	$\mu s$
$t_{OFF}$	Output Turn-OFF Delay Time	$R_L = 10\Omega, C_{SS} = 1000pF, C_L = 0.1\mu F$	-	9.6	-	$\mu s$
$t_D$	Output Start Delay	$R_L = 10\Omega, C_{SS} = 1000pF, C_L = 0.1\mu F$	-	160	-	$\mu s$
<b><math>V_{IN} = 0.8V, V_{EN} = V_{BIAS} = 5V, T_A = +25^{\circ}C</math></b>						
$t_{RISE}$	Output Rise-time	$R_L = 10\Omega, C_{SS} = 1000pF, C_L = 0.1\mu F$	-	330	-	$\mu s$
$t_{ON}$	Output Turn-ON Delay Time	$R_L = 10\Omega, C_{SS} = 1000pF, C_L = 0.1\mu F$	-	428	-	$\mu s$
$t_{FALL}$	Output Fall-time	$R_L = 10\Omega, C_{SS} = 1000pF, C_L = 0.1\mu F$	-	11	-	$\mu s$
$t_{OFF}$	Output Turn-OFF Delay Time	$R_L = 10\Omega, C_{SS} = 1000pF, C_L = 0.1\mu F$	-	146	-	$\mu s$
$t_D$	Output Start Delay	$R_L = 10\Omega, C_{SS} = 1000pF, C_L = 0.1\mu F$	-	253	-	$\mu s$
<b><math>V_{IN} = 2.5V, V_{EN} = 5V, V_{BIAS} = 2.5V, T_A = +25^{\circ}C</math></b>						
$t_{RISE}$	Output Rise-time	$R_L = 10\Omega, C_{SS} = 1000pF, C_L = 0.1\mu F$	-	1488	-	$\mu s$
$t_{ON}$	Output Turn-ON Delay Time	$R_L = 10\Omega, C_{SS} = 1000pF, C_L = 0.1\mu F$	-	1381	-	$\mu s$
$t_{FALL}$	Output Fall-time	$R_L = 10\Omega, C_{SS} = 1000pF, C_L = 0.1\mu F$	-	3	-	$\mu s$
$t_{OFF}$	Output Turn-OFF Delay Time	$R_L = 10\Omega, C_{SS} = 1000pF, C_L = 0.1\mu F$	-	11	-	$\mu s$
$t_D$	Output Start Delay	$R_L = 10\Omega, C_{SS} = 1000pF, C_L = 0.1\mu F$	-	359	-	$\mu s$
<b><math>V_{IN} = 0.8V, V_{EN} = 5V, V_{BIAS} = 2.5V, T_A = +25^{\circ}C</math></b>						
$t_{RISE}$	Output Rise-time	$R_L = 10\Omega, C_{SS} = 1000pF, C_L = 0.1\mu F$	-	561	-	$\mu s$
$t_{ON}$	Output Turn-ON Delay Time	$R_L = 10\Omega, C_{SS} = 1000pF, C_L = 0.1\mu F$	-	748	-	$\mu s$
$t_{FALL}$	Output Fall-time	$R_L = 10\Omega, C_{SS} = 1000pF, C_L = 0.1\mu F$	-	11	-	$\mu s$
$t_{OFF}$	Output Turn-OFF Delay Time	$R_L = 10\Omega, C_{SS} = 1000pF, C_L = 0.1\mu F$	-	123	-	$\mu s$
$t_D$	Output Start Delay	$R_L = 10\Omega, C_{SS} = 1000pF, C_L = 0.1\mu F$	-	415	-	$\mu s$

**Performance Characteristics** (@ $T_A = +25^\circ\text{C}$ ,  $V_{BIAS} = 5\text{V}$ , unless otherwise specified.)

NEW PRODUCT

**$V_{BIAS}$  vs. QUIESCENT CURRENT (BOTH CHANNELS)**

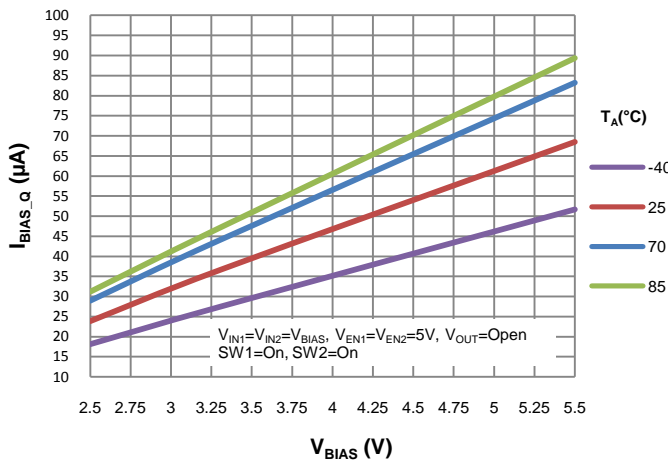

**$V_{BIAS}$  vs. QUIESCENT CURRENT (SINGLE CHANNEL)**

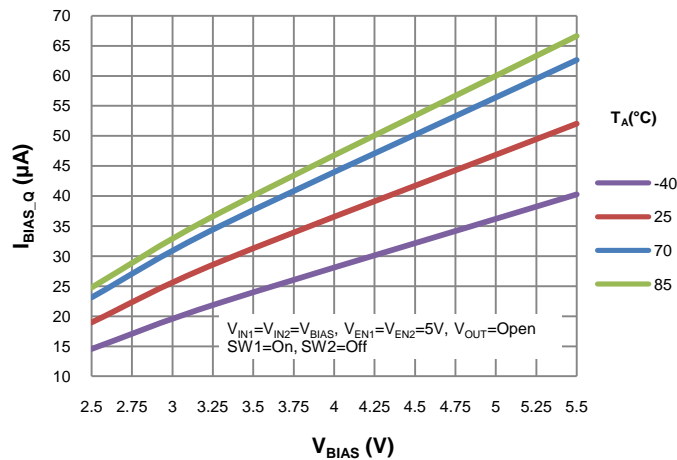

**$V_{BIAS}$  vs. SHUTDOWN CURRENT (BOTH CHANNELS)**

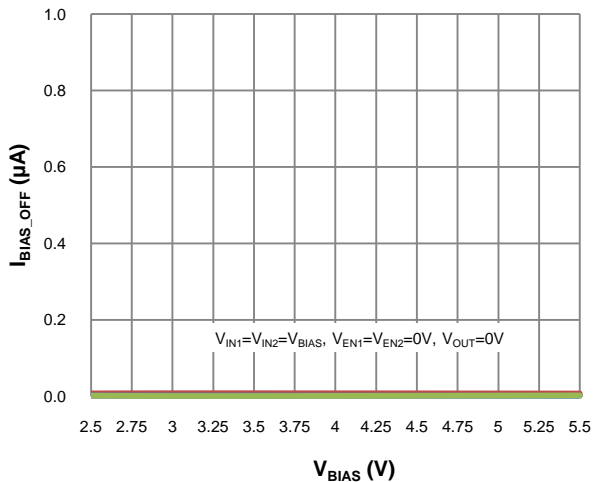

**$V_{IN}$  vs. OFF-STATE  $V_{IN}$  CURRENT (SINGLE CHANNEL)**

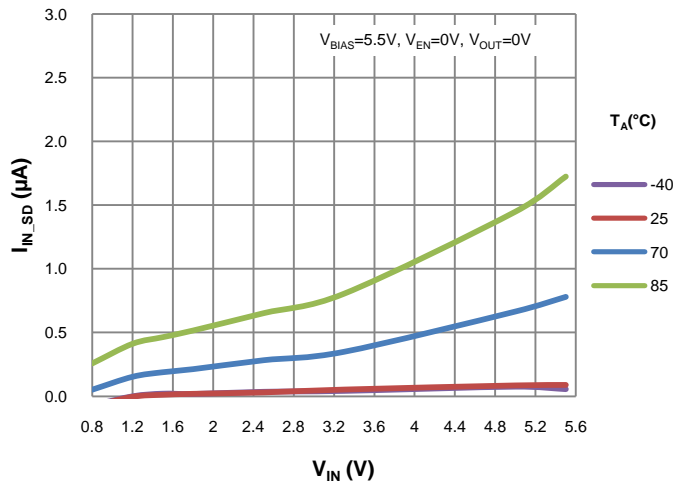

**TEMPERATURE vs.  $R_{ON}$  ( $V_{BIAS}=2.5\text{V}$ , SINGLE CHANNEL)**

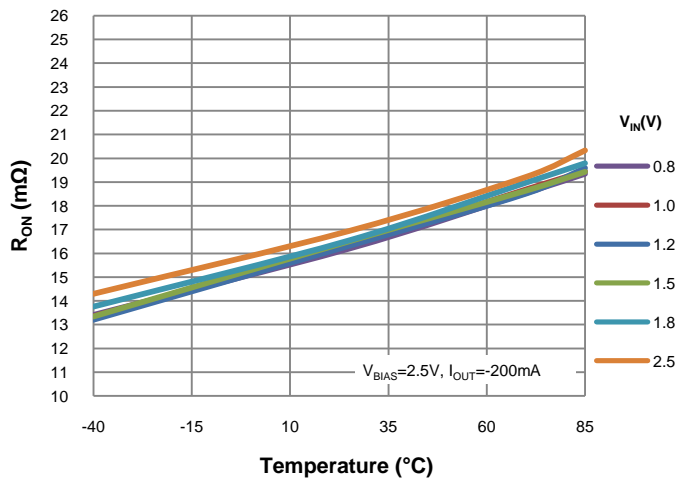

**TEMPERATURE vs.  $R_{ON}$  ( $V_{BIAS}=5.5\text{V}$ , SINGLE CHANNEL)**

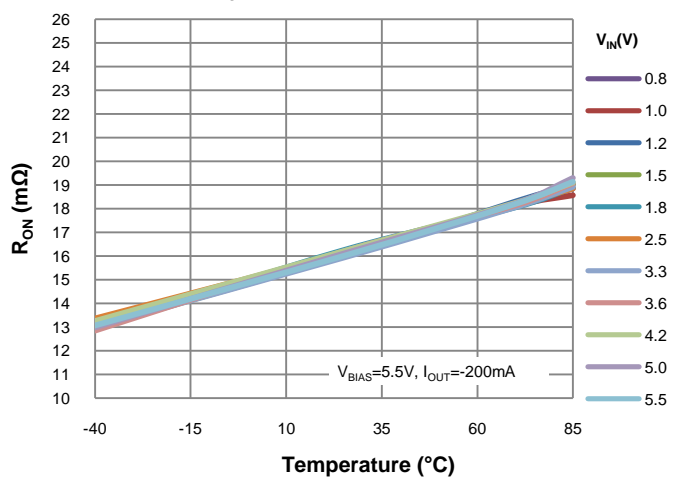

**Performance Characteristics** (cont.) (@ $T_A = +25^\circ\text{C}$ ,  $V_{BIAS} = 5\text{V}$ , unless otherwise specified.)

NEW PRODUCT

$V_{IN}$  vs.  $R_{ON}$  ( $V_{BIAS}=2.5\text{V}$ , SINGLE CHANNEL)

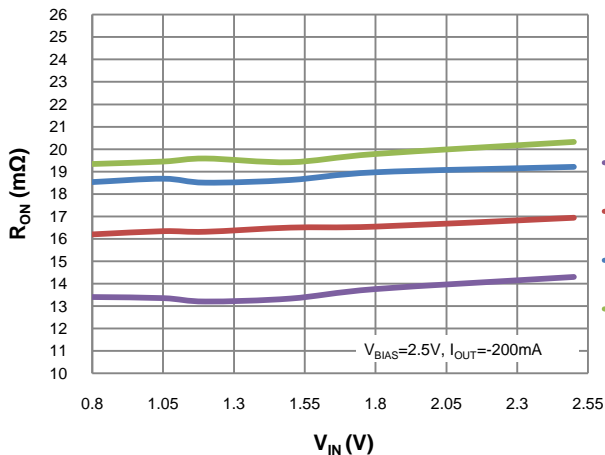

$V_{IN}$  vs.  $R_{ON}$  ( $V_{BIAS}=5.5\text{V}$ , SINGLE CHANNEL)

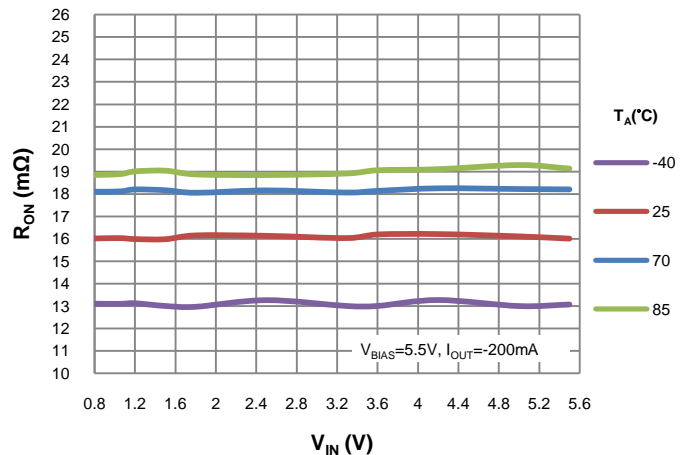

$V_{IN}$  vs.  $R_{ON}$  ( $T_A=25^\circ\text{C}$ , SINGLE CHANNEL)

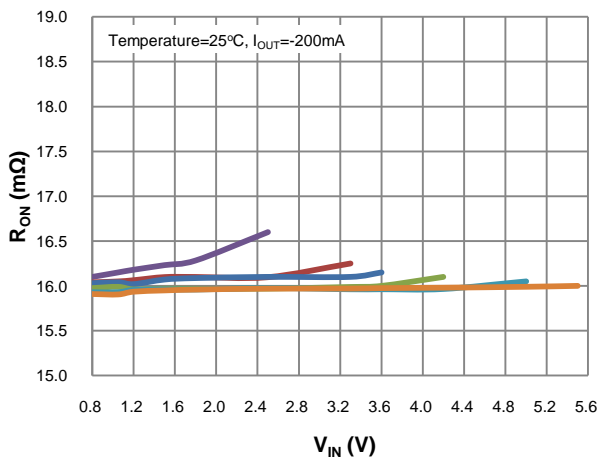

$V_{IN}$  vs.  $R_{DIS}$  ( $V_{BIAS}=5.5\text{V}$ , SINGLE CHANNEL)

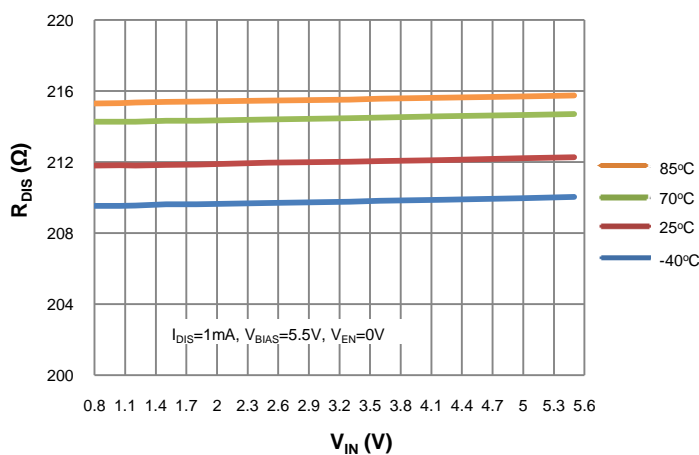

$V_{EN}$  vs.  $V_{OUT}$  ( $T_A=25^\circ\text{C}$ , SINGLE CHANNEL)

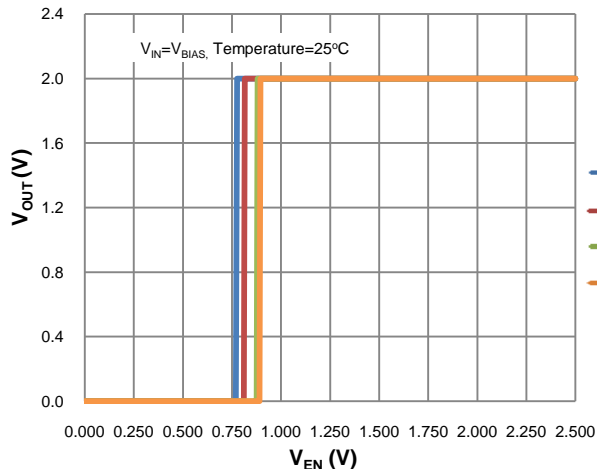

$t_D$  vs  $V_{IN}$ ,  $V_{BIAS}=2.5\text{V}$   
( $C_{IN}=1\mu\text{F}$ ,  $C_{SS}=1\text{nF}$ ,  $R_L=10\Omega$ ,  $C_L=0.1\mu\text{F}$ )

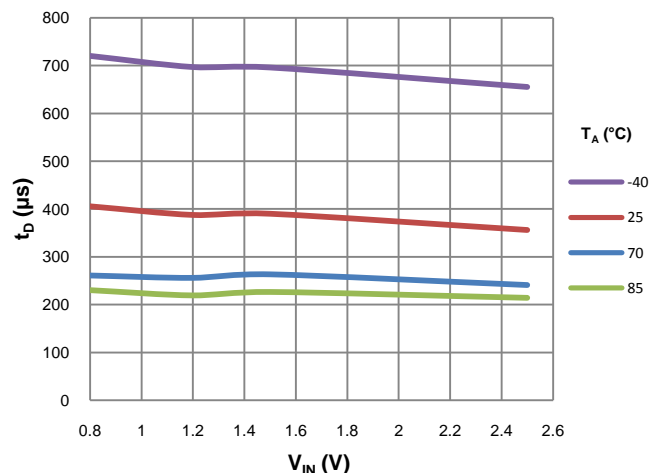

**Performance Characteristics** (cont.) (@ $T_A = +25^\circ\text{C}$ ,  $V_{BIAS} = 5\text{V}$ , unless otherwise specified.)

NEW PRODUCT

$t_D$  vs  $V_{IN}$ ,  $V_{BIAS}=5.5\text{V}$   
( $C_{IN}=1\mu\text{F}$ ,  $C_{SS}=1\text{nF}$ ,  $R_L=10\Omega$ ,  $C_L=0.1\mu\text{F}$ )

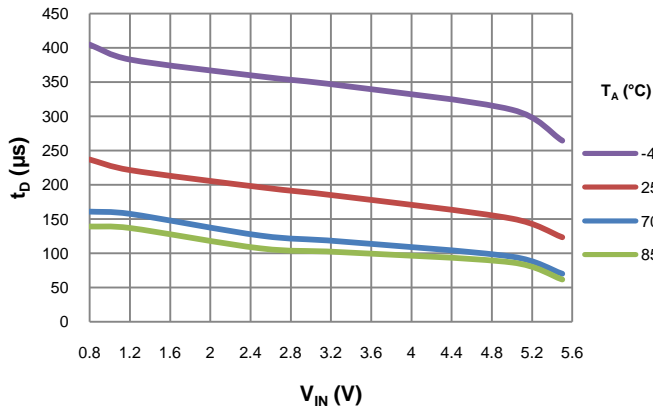

$t_F$  vs  $V_{IN}$ ,  $V_{BIAS}=2.5\text{V}$   
( $C_{IN}=1\mu\text{F}$ ,  $C_{SS}=1\text{nF}$ ,  $R_L=10\Omega$ ,  $C_L=0.1\mu\text{F}$ )

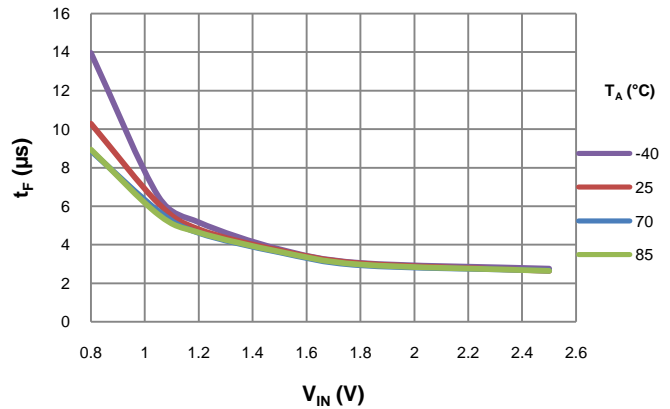

$t_F$  vs  $V_{IN}$ ,  $V_{BIAS}=5.5\text{V}$   
( $C_{IN}=1\mu\text{F}$ ,  $C_{SS}=1\text{nF}$ ,  $R_L=10\Omega$ ,  $C_L=0.1\mu\text{F}$ )

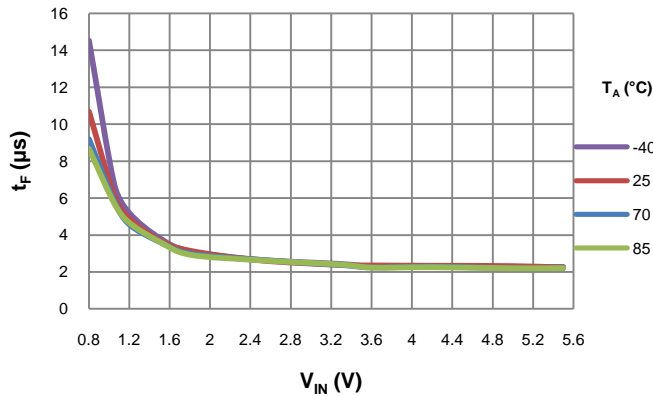

$t_{OFF}$  vs  $V_{IN}$ ,  $V_{BIAS}=2.5\text{V}$   
( $C_{IN}=1\mu\text{F}$ ,  $C_{SS}=1\text{nF}$ ,  $R_L=10\Omega$ ,  $C_L=0.1\mu\text{F}$ )

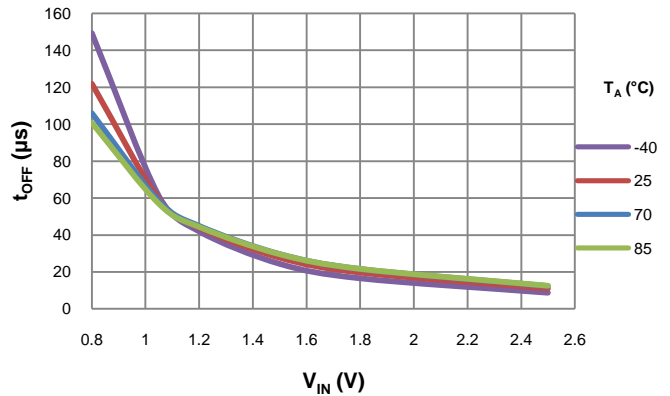

$t_{OFF}$  vs  $V_{IN}$ ,  $V_{BIAS}=5.5\text{V}$   
( $C_{IN}=1\mu\text{F}$ ,  $C_{SS}=1\text{nF}$ ,  $R_L=10\Omega$ ,  $C_L=0.1\mu\text{F}$ )

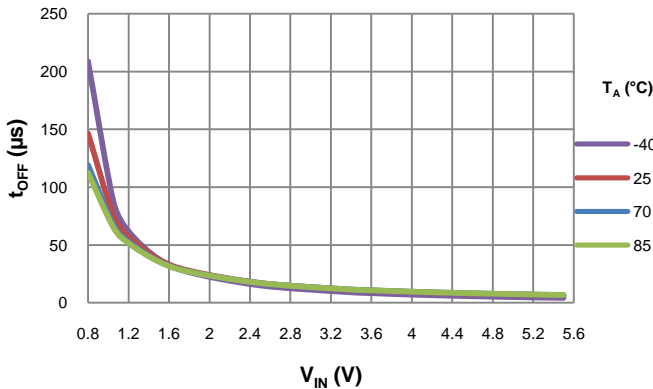

$t_{ON}$  vs  $V_{IN}$ ,  $V_{BIAS}=2.5\text{V}$   
( $C_{IN}=1\mu\text{F}$ ,  $C_{SS}=1\text{nF}$ ,  $R_L=10\Omega$ ,  $C_L=0.1\mu\text{F}$ )

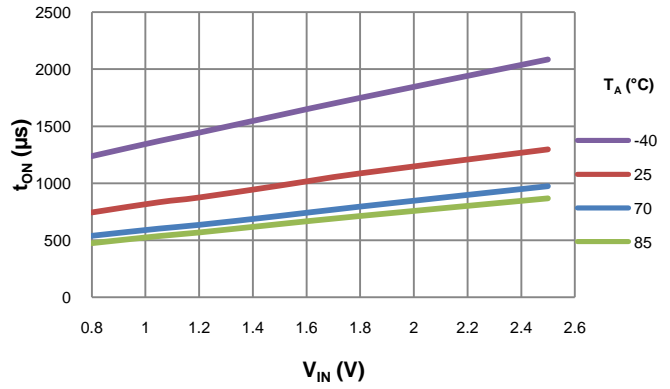



**Performance Characteristics** (cont.) (@ $T_A = +25^\circ\text{C}$ ,  $V_{\text{BIAS}} = 5\text{V}$ , unless otherwise specified.)

NEW PRODUCT

$t_{\text{ON}}$  vs  $V_{\text{IN}}$ ,  $V_{\text{BIAS}}=5.5\text{V}$   
( $C_{\text{IN}}=1\mu\text{F}$ ,  $C_{\text{SS}}=1\text{nF}$ ,  $R_L=10\Omega$ ,  $C_L=0.1\mu\text{F}$ )

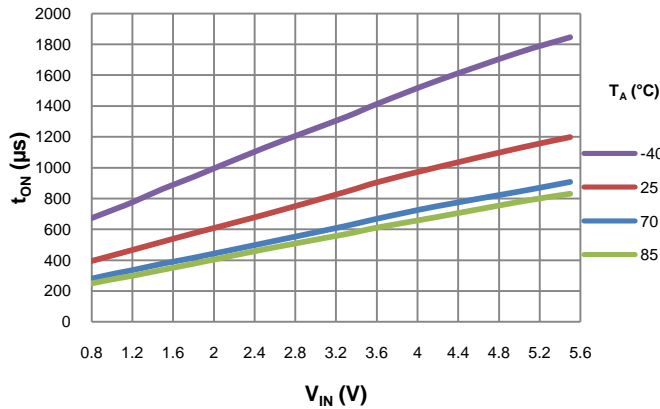

$t_{\text{R}}$  vs  $V_{\text{IN}}$ ,  $V_{\text{BIAS}}=2.5\text{V}$   
( $C_{\text{IN}}=1\mu\text{F}$ ,  $C_{\text{SS}}=1\text{nF}$ ,  $R_L=10\Omega$ ,  $C_L=0.1\mu\text{F}$ )

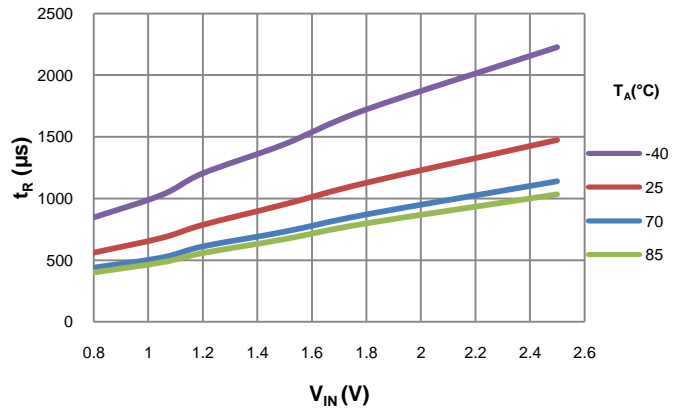

$t_{\text{R}}$  vs  $V_{\text{IN}}$ ,  $V_{\text{BIAS}}=5.5\text{V}$   
( $C_{\text{IN}}=1\mu\text{F}$ ,  $C_{\text{SS}}=1\text{nF}$ ,  $R_L=10\Omega$ ,  $C_L=0.1\mu\text{F}$ )

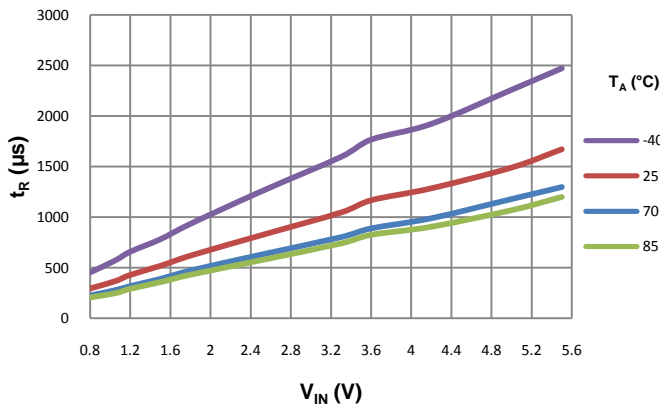

$t_{\text{R}}$  vs  $V_{\text{BIAS}}$ ,  $V_{\text{IN}}=2.5\text{V}$   
( $C_{\text{IN}}=1\mu\text{F}$ ,  $C_{\text{SS}}=1\text{nF}$ ,  $R_L=10\Omega$ ,  $C_L=0.1\mu\text{F}$ )

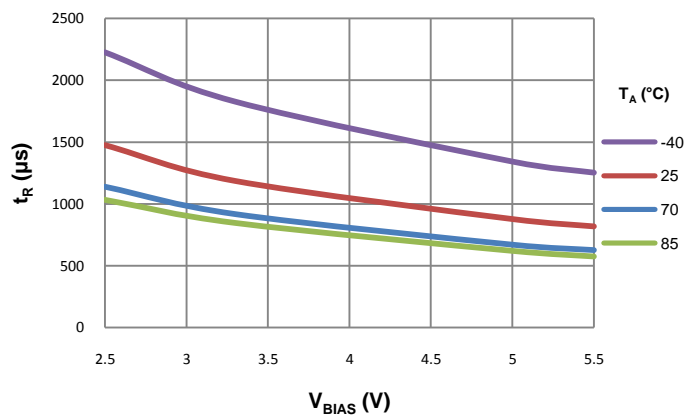

**Turn ON Response Time**  
 $V_{\text{IN}}=0.8\text{V}$ ,  $V_{\text{BIAS}}=2.5\text{V}$ ,  $C_{\text{IN}}=1\mu\text{F}$ ,  $C_L=0.1\mu\text{F}$ ,  $C_{\text{SS}}=1\text{nF}$ ,  $R_L=10\Omega$

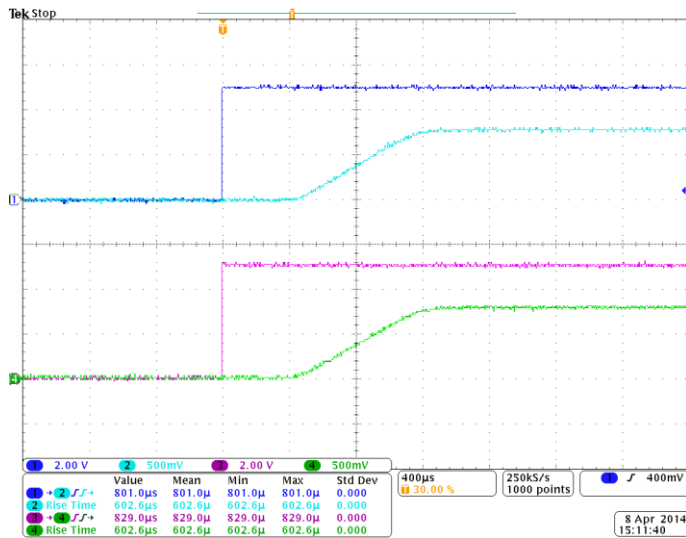

**Turn ON Response Time**  
 $V_{\text{IN}}=0.8\text{V}$ ,  $V_{\text{BIAS}}=5\text{V}$ ,  $C_{\text{IN}}=1\mu\text{F}$ ,  $C_L=0.1\mu\text{F}$ ,  $C_{\text{SS}}=1\text{nF}$ ,  $R_L=10\Omega$

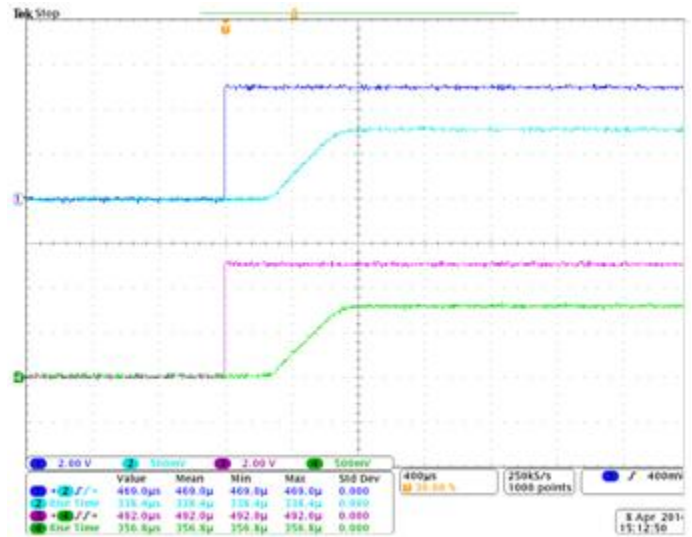

**Performance Characteristics** (cont.) (@ $T_A = +25^\circ\text{C}$ ,  $V_{BIAS} = 5\text{V}$ , unless otherwise specified.)

NEW PRODUCT

**Turn ON Response Time**  
 $V_{IN}=2.5\text{V}$ ,  $V_{BIAS}=2.5\text{V}$ ,  $C_{IN}=1\mu\text{F}$ ,  $C_L=0.1\mu\text{F}$ ,  $C_{SS}=1\text{nF}$ ,  $R_L=10\Omega$

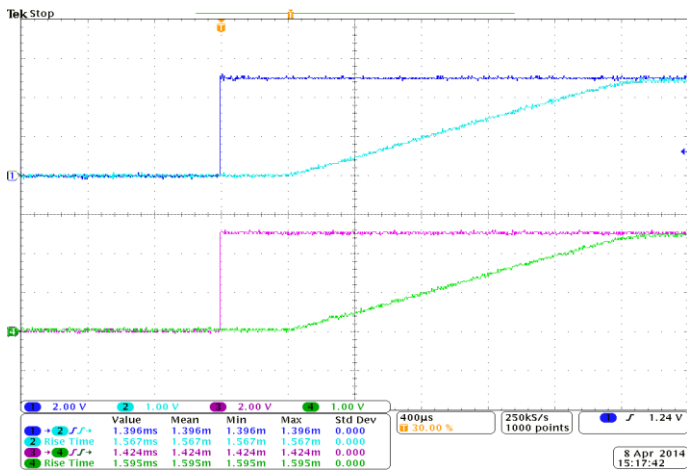

**Turn ON Response Time**  
 $V_{IN}=5\text{V}$ ,  $V_{BIAS}=5\text{V}$ ,  $C_{IN}=1\mu\text{F}$ ,  $C_L=0.1\mu\text{F}$ ,  $C_{SS}=1\text{nF}$ ,  $R_L=10\Omega$

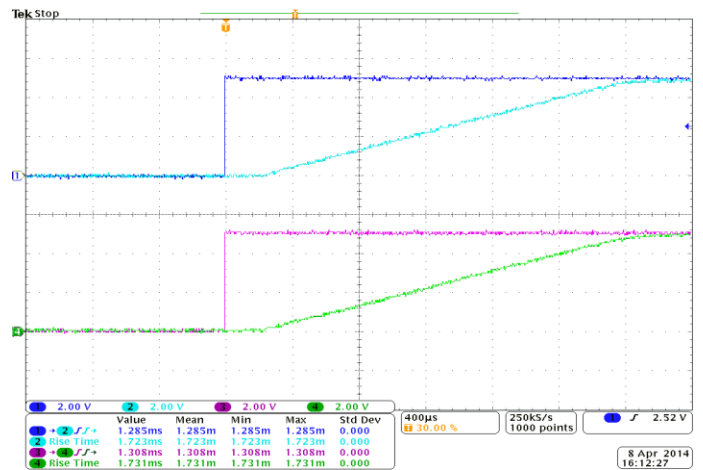

**Turn OFF Response Time**  
 $V_{IN}=0.8\text{V}$ ,  $V_{BIAS}=2.5\text{V}$ ,  $C_{IN}=1\mu\text{F}$ ,  $C_L=0.1\mu\text{F}$ ,  $C_{SS}=1\text{nF}$ ,  $R_L=10\Omega$

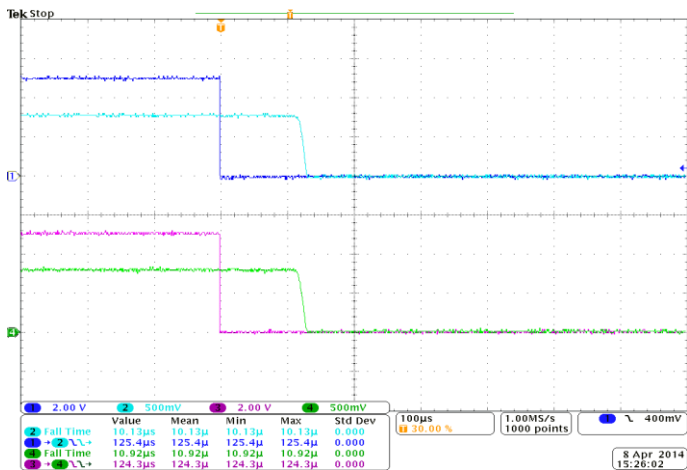

**Turn OFF Response Time**  
 $V_{IN}=0.8\text{V}$ ,  $V_{BIAS}=5\text{V}$ ,  $C_{IN}=1\mu\text{F}$ ,  $C_L=0.1\mu\text{F}$ ,  $C_{SS}=1\text{nF}$ ,  $R_L=10\Omega$

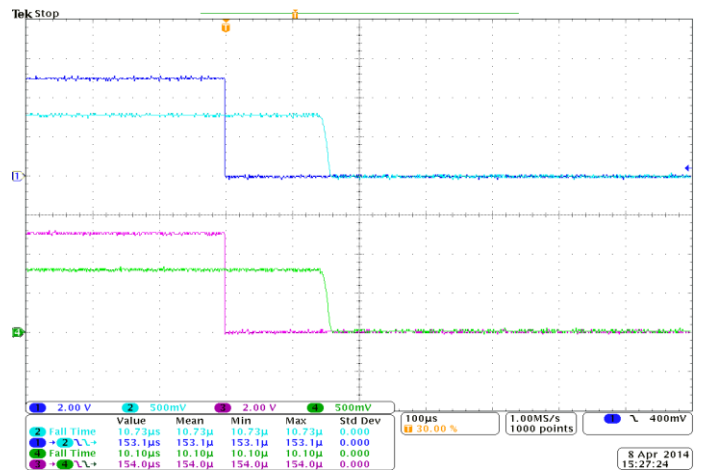

**Turn OFF Response Time**  
 $V_{IN}=2.5\text{V}$ ,  $V_{BIAS}=2.5\text{V}$ ,  $C_{IN}=1\mu\text{F}$ ,  $C_L=0.1\mu\text{F}$ ,  $C_{SS}=1\text{nF}$ ,  $R_L=10\Omega$

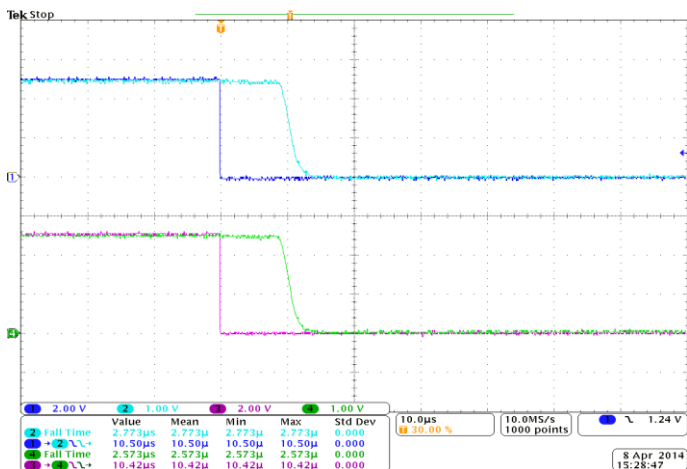

**Turn OFF Response Time**  
 $V_{IN}=5\text{V}$ ,  $V_{BIAS}=5\text{V}$ ,  $C_{IN}=1\mu\text{F}$ ,  $C_L=0.1\mu\text{F}$ ,  $C_{SS}=1\text{nF}$ ,  $R_L=10\Omega$

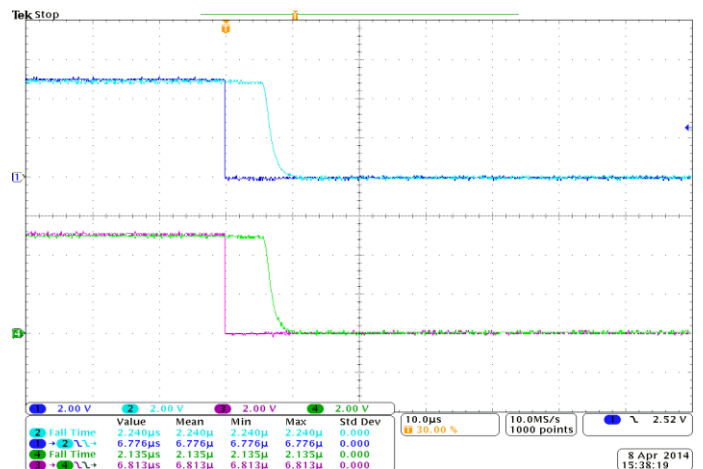

## Application Information

### Enable/Disable CONTROL

The EN pins control the state of the two switches. AP22966 is enabled when the EN pins are asserted high, and, the device is disabled when EN pins are asserted low. The EN input is compatible with both TTL and CMOS logic. This pin cannot be left floating and must be tied either high or low for proper functionality.

### INPUT CAPACITOR

To limit the voltage drop on the input supply when the switch turns on into a discharged load capacitor resulting in a transient inrush current, a capacitor needs to be placed between VIN and GND. Use 1µF capacitor or a larger value for high-current applications. Place the capacitor close to the VIN pins.

### OUTPUT CAPACITOR

The recommended output capacitor value is 0.1µF when switching lighter loads. For heavier loads close to 6A, it is recommended that the VIN and VOUT trace lengths be kept to a minimum. In addition, a bulk capacitor (≥ 10µF) may also be placed close to the VOUT pins. If using a bulk capacitor on VOUT, it is important to control the inrush current by choosing an appropriate soft-start time in order to minimize the droop on the input supply.

### SOFT-START TIME

A capacitor on the SS pins (to GND) sets the slew rate for each channel. To ensure desired performance, a capacitor with a minimum voltage rating of 25V should be placed on the SS pins. The input inrush current can be controlled by choosing an appropriate soft-start time. The table below shows the rise-time (10% to 90%) on VOUT for a variety of VIN and CSS conditions.

C <sub>SS</sub> (pF)	Soft-start Time (µs) 10% - 90%, V <sub>BIAS</sub> = 5V, C <sub>L</sub> = 0.1µF, C <sub>IN</sub> = 1µF, R <sub>L</sub> = 10Ω, Typical Values are at T <sub>A</sub> =+25°C						
	5V	3.3V	1.8V	1.5V	1.2V	1.05V	0.8V
0	129	93	67	61	59	57	47
220	452	310	177	148	125	112	96
470	898	610	351	290	241	210	166
1000	1609	1130	661	557	454	397	315
2200	3453	2371	1483	1224	1019	870	710
4700	7202	4978	2900	2394	2014	1728	1430
10000	13673	9774	5728	4778	3982	3370	2762

### THERMAL CONSIDERATION

The maximum junction temperature should be restricted to +125°C under normal operating conditions. The maximum allowable power dissipation P<sub>D(MAX)</sub> can be calculated as:

$$P_{D(MAX)} = (T_{J(MAX)} - T_A) / \theta_{JA}$$

where,

T<sub>J(MAX)</sub> is the maximum operating junction temperature. For AP22966, T<sub>J(MAX)</sub> = 125°C

T<sub>A</sub> is the ambient temperature of the device

θ<sub>JA</sub> is the junction-to-air thermal impedance

### BOARD LAYOUT

Good PCB layout is important for improving the thermal performance of the device. All trace lengths should be kept as short as possible. Place input and output capacitors close to the device to minimize the effects of parasitic inductance. The input and output PCB traces should be as wide as possible. Use a ground plane to enhance the power dissipation capability of the device.

**Ordering Information**

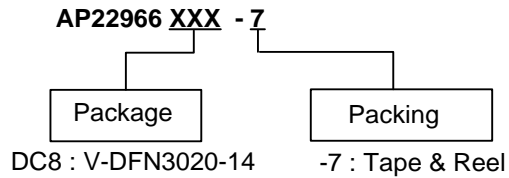

Part Number	Package Code	Packaging	7" Tape and Reel	
			Quantity	Part Number Suffix
AP22966DC8-7	DC8	V-DFN3020-14	3000/Tape & Reel	-7

**Marking Information**

V-DFN3020-14

( Top View )

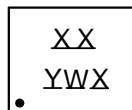

- XX : Identification Code
- Y : Year : 0~9
- W : Week : A~Z : 1~26 week;  
a~z : 27~52 week; z represents 52 and 53 week
- X : Internal Code

Part Number	Package	Identification Code
AP22966DC8-7	V-DFN3020-14	WE

**Package Outline Dimensions**

Please see AP02002 at <http://www.diodes.com/datasheets/ap02002.pdf> for latest version.

V-DFN3020-14

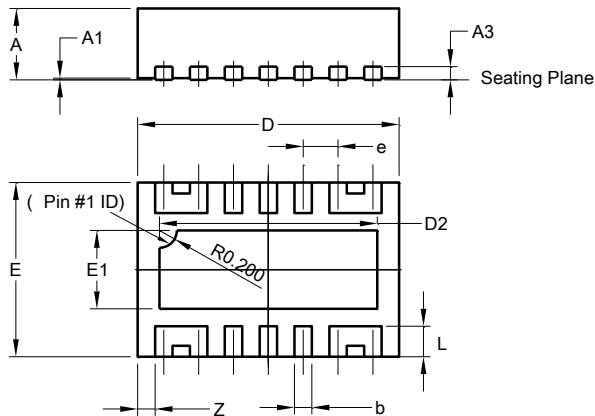

V-DFN3020-14			
Dim	Min	Max	Typ
A	0.77	0.83	0.80
A1	0	0.05	0.02
A3	-	-	0.15
b	0.15	0.25	0.20
D	2.95	3.05	3.00
D2	2.40	2.60	2.50
E	1.95	2.05	2.00
E1	0.80	1.00	0.90
e	-	-	0.40
L	0.30	0.40	0.35
Z	-	-	0.20
All Dimensions in mm			

**Suggested Pad Layout**

Please see AP02001 at <http://www.diodes.com/datasheets/ap02001.pdf> for the latest version.

V-DFN3020-14

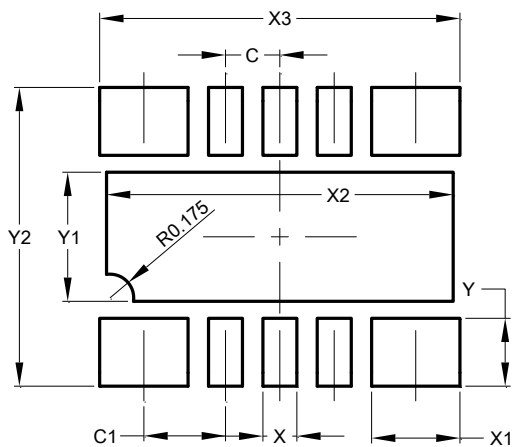

Dimensions	Value (in mm)
C	0.400
C1	0.600
X	0.250
X1	0.650
X2	2.550
X3	2.650
Y	0.500
Y1	0.950
Y2	2.200

**IMPORTANT NOTICE**

DIODES INCORPORATED MAKES NO WARRANTY OF ANY KIND, EXPRESS OR IMPLIED, WITH REGARDS TO THIS DOCUMENT, INCLUDING, BUT NOT LIMITED TO, THE IMPLIED WARRANTIES OF MERCHANTABILITY AND FITNESS FOR A PARTICULAR PURPOSE (AND THEIR EQUIVALENTS UNDER THE LAWS OF ANY JURISDICTION).

Diodes Incorporated and its subsidiaries reserve the right to make modifications, enhancements, improvements, corrections or other changes without further notice to this document and any product described herein. Diodes Incorporated does not assume any liability arising out of the application or use of this document or any product described herein; neither does Diodes Incorporated convey any license under its patent or trademark rights, nor the rights of others. Any Customer or user of this document or products described herein in such applications shall assume all risks of such use and will agree to hold Diodes Incorporated and all the companies whose products are represented on Diodes Incorporated website, harmless against all damages.

Diodes Incorporated does not warrant or accept any liability whatsoever in respect of any products purchased through unauthorized sales channel. Should Customers purchase or use Diodes Incorporated products for any unintended or unauthorized application, Customers shall indemnify and hold Diodes Incorporated and its representatives harmless against all claims, damages, expenses, and attorney fees arising out of, directly or indirectly, any claim of personal injury or death associated with such unintended or unauthorized application.

Products described herein may be covered by one or more United States, international or foreign patents pending. Product names and markings noted herein may also be covered by one or more United States, international or foreign trademarks.

This document is written in English but may be translated into multiple languages for reference. Only the English version of this document is the final and determinative format released by Diodes Incorporated.

**LIFE SUPPORT**

Diodes Incorporated products are specifically not authorized for use as critical components in life support devices or systems without the express written approval of the Chief Executive Officer of Diodes Incorporated. As used herein:

A. Life support devices or systems are devices or systems which:

1. are intended to implant into the body, or
2. support or sustain life and whose failure to perform when properly used in accordance with instructions for use provided in the labeling can be reasonably expected to result in significant injury to the user.

B. A critical component is any component in a life support device or system whose failure to perform can be reasonably expected to cause the failure of the life support device or to affect its safety or effectiveness.

Customers represent that they have all necessary expertise in the safety and regulatory ramifications of their life support devices or systems, and acknowledge and agree that they are solely responsible for all legal, regulatory and safety-related requirements concerning their products and any use of Diodes Incorporated products in such safety-critical, life support devices or systems, notwithstanding any devices- or systems-related information or support that may be provided by Diodes Incorporated. Further, Customers must fully indemnify Diodes Incorporated and its representatives against any damages arising out of the use of Diodes Incorporated products in such safety-critical, life support devices or systems.

Copyright © 2014, Diodes Incorporated

[www.diodes.com](http://www.diodes.com)