

Applications

- WiFi/ ISM notch filter to enable coexistence between WiMAX/LTE/TD-LTE & WiFi/BT/ISM radios
- Applicable passbands: 2.6 GHz WiMAX/LTE, 2.3 GHz WiMAX/LTE, LTE Bands 7 & 38, TD-LTE Band 40, WCS, WiBro, Indian 2.3 GHz 4 G band
- Handsets
- Portable Hotspots
- Mobile Routers
- Smart Meters

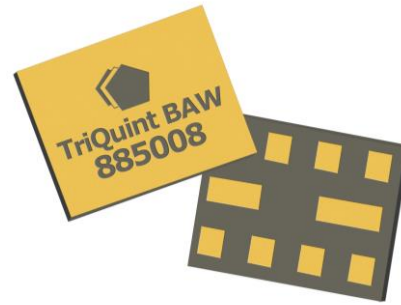

CSP-1713BT package: 1.7 x 1.3 x 0.46 mm

Product Features

- Rejects 2.4 GHz WiFi/ ISM bands
- Low Loss in 2496-2690 MHz bands: WiMAX/LTE/TD-LTE/Bands 7 & 38
- Low Loss in 2300-2370 MHz bands: WiMAX/WCS/WiBro/Band 40/Indian 4G band
- Industry-leading small size: 1.7 x 1.3 x .46 mm
- Power Handling: +28 dBm (ave), +37.5 dBm (peak)
- Performance -30 °C to +85 °C
- Ceramic chip-scale Package (CSP)
- Hermetically Sealed
- RoHS compliant, Pb-free

Functional Block Diagram

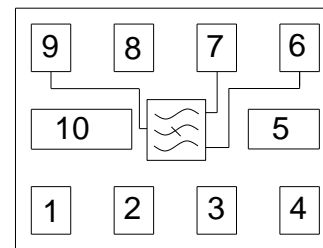

General Description

885008 is a high-performance Bulk Acoustic Wave (BAW) notch filter designed to reject emissions in the WiFi bands, while passing both the 2.3 GHz & 2.6 GHz WiMAX/LTE/TD-LTE bands.

885008 is specifically designed to enable coexistence of WiFi and 4 G signals within the same device or in close proximity to one another. The part is specified to provide

Low loss in the entire USA WiMAX band (2496-2690 MHz) as well as LTE Bands 7 & 38. The filter also passes the 2.3 GHz band: WiBro, WCS, Band 40 & the Indian 4 G band.

885008 uses inexpensive packaging techniques to achieve an industry-leading 1.7 x 1.3 x .46 mm package. The filter exhibits excellent power handling capabilities.

885008 is referenced on multiple designs with the leading WiMAX chipset makers.

Pin Configuration

Pin No.	Label
9	Input
6	Output
7	AUX1
8	N/C
1-5, 10	Ground

Ordering Information

Part No.	Description
885008	Packaged part
885008-EVB	Evaluation board

Standard T/R size = 10,000 units/reel

Absolute Maximum Ratings

Parameter	Rating
Storage Temperature ⁽¹⁾	-40 °C to +85 °C
Operating Temperature ⁽²⁾	-30 °C to +85 °C
Input Power ^{(in passband, CW signal) (3)}	+28 dBm

1. Operation of this device outside the parameter ranges given may cause permanent damage.
2. Specifications are not guaranteed over operating conditions.
3. Power handling capability supports WiMAX/OFDM applications

Electrical Specifications ⁽¹⁾

Conditions unless otherwise noted: Device Temperature = +25 °C

Parameter ⁽²⁾	Conditions	Min	Typ (+25 °C)	Max	Units
Center Frequency		-	2440	-	MHz
Maximum Insertion Loss	2496 – 2700 MHz (T > 0 °C)	-	2.0	2.8	dB
Absolute Attenuation ⁽⁴⁾	2401 – 2472 MHz	20	25	-	dB

Conditions unless otherwise noted: Device Temperature = -30 °C to +85 °C.

Parameter ⁽²⁾	Conditions	Min	Typ (+25 °C)	Max	Units
Maximum Insertion Loss	2496 – 2700 MHz	-	2.5	3.2	dB
Absolute attenuation ⁽⁴⁾	2401 – 2472 MHz	14	25	-	dB
Input / Output Return Loss	2496 – 2700 MHz	6	12	-	dB
Amplitude Ripple	2496 – 2700 MHz	-	1.5	-	dB p-p
Source Impedance ⁽⁵⁾	(single-ended)	-	50	-	Ω
Load Impedance ⁽⁵⁾	(single-ended)	-	50	-	Ω

Notes:

1. All specifications are based on the TriQuint schematic for the main reference design shown on page 3
2. In production, devices will be tested at room temperature to a guardbanded specification to ensure electrical compliance over temperature
3. Typical values are based on average measurements at room temperature, unless otherwise noted
4. Relative to zero dB
5. This is the optimum impedance in order to achieve the performance shown.

Reference Design - 50Ω SE input, 50Ω Output

Schematic (top view)

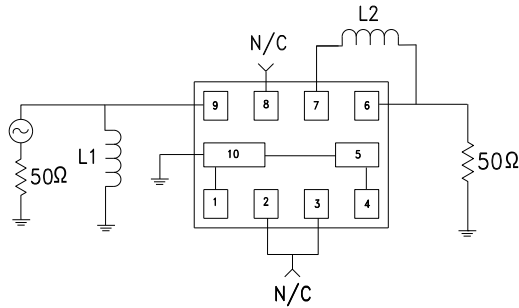

Pin Function

1	Input Ret Gnd – connect to 10
2,3	Ground – N/C
4	Output Ret Gnd – connect to 5
5	Ground – connect to 10
6	Output
7	Output 2 (AUX1)
8	N/C
9	Input
10	Ground

PC Board

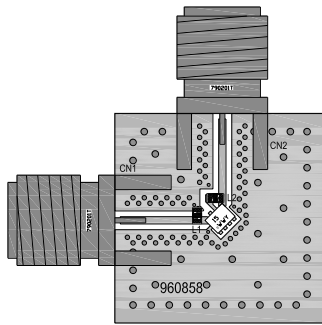

PCB routing detail

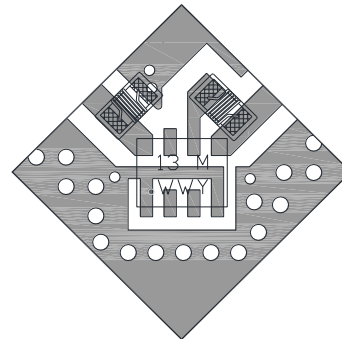

Notes:

1. Top, middle & bottom layers: 1 oz copper.
2. Substrates: FR4 dielectric, .031" thick.
3. Finish plating: Nickel: 3-8 μm thick, Gold: .03-.2 μm thick.
4. Hole plating: Copper min .0008 μm thick.

Notes:

1. Grey indicates metalized area.
2. This footprint represents a recommendation only.
3. For solder recommendation see mechanical information.

Bill of Material

Reference Des.	Value	Description	Manuf.	Part Number
L1	4.3 nH	Coil Wire-wound, 0402, ± 0.2 nH	MuRata	LQW15AN4N3C00
L2	3.9 nH	Coil Wire-wound, 0402, ± 0.2 nH	MuRata	LQW15AN3N9C00
SMA	N/A	SMA connector	Radiall USA	9602-1111-018
PCB	N/A	3-layer	Multiple	960858a

Notes:

1. Actual matching values may vary due to PCB layout and parasitics.
2. Ground paths are optimized for maximum attenuation in WLAN band.

Performance Plots

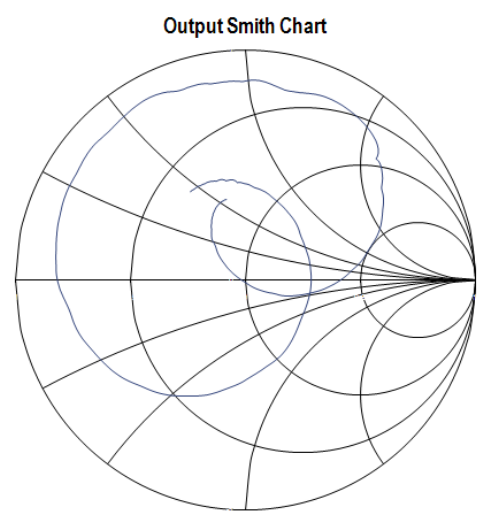
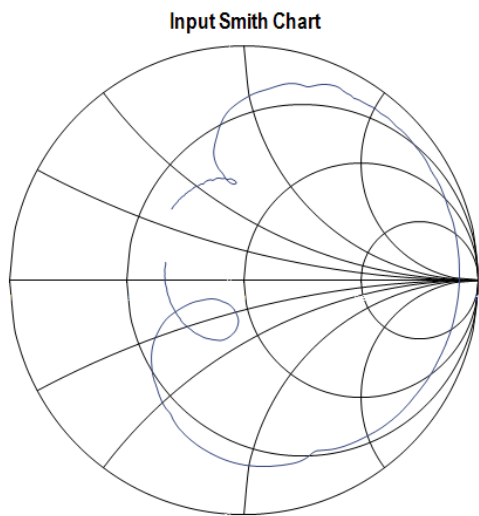
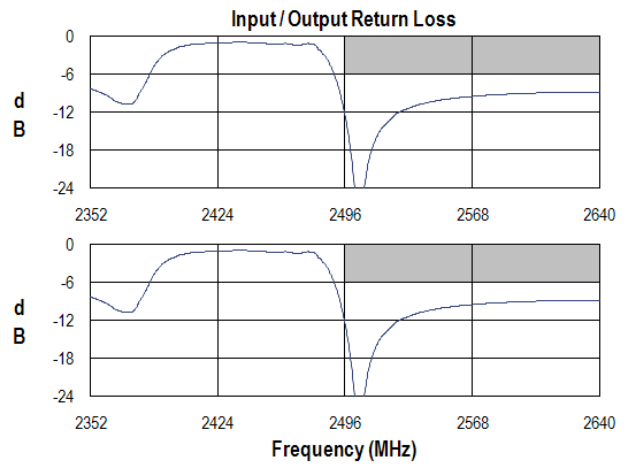
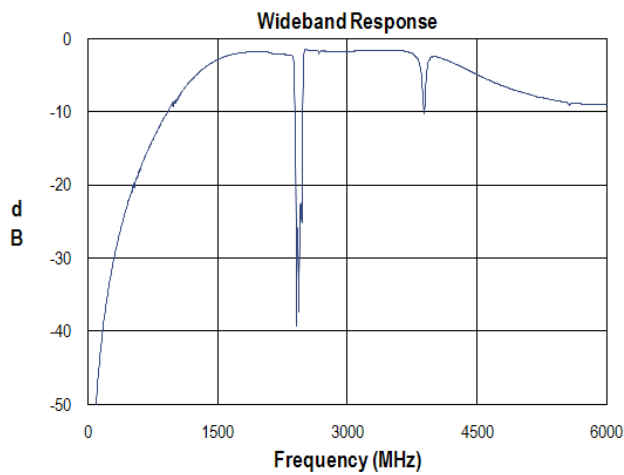
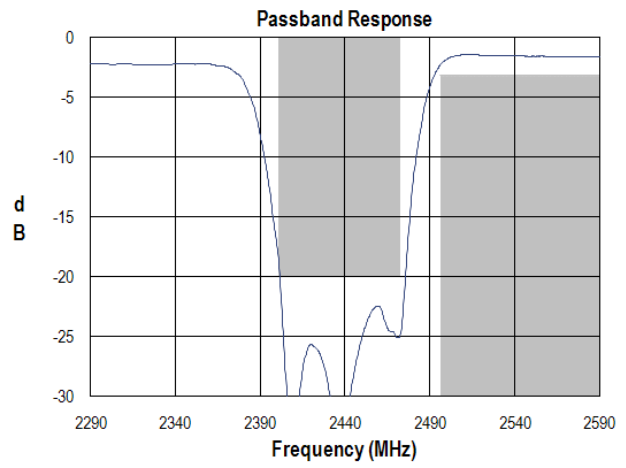
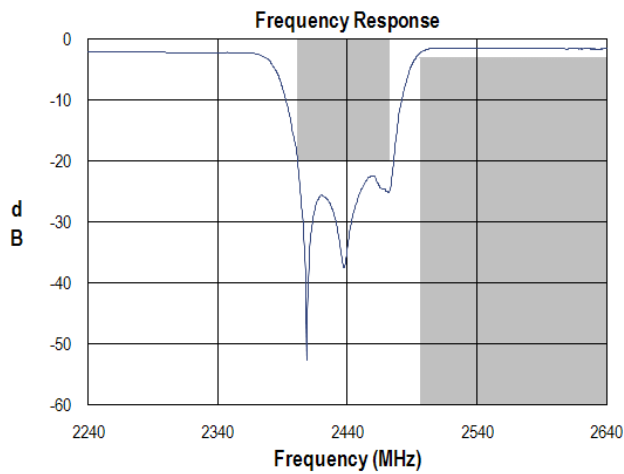

Package Information, Marking and Dimensions

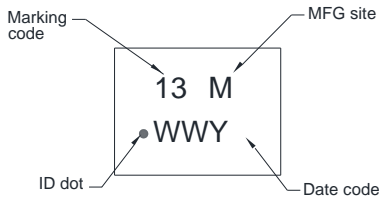

Package Style: CSP-1713
Dimensions: 1.70 x 1.30 x 0.46 mm

Body: Al_2O_3 ceramic
Lid: Kovar, or Alloy 42 over Ni plated.
Terminations: Au plating 0.5 - 1.0 μm , over a 2-6 μm Ni plating

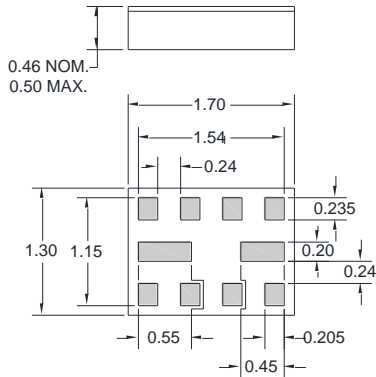

All dimensions shown are nominal in millimeters
All tolerances are ± 0.15 mm except overall length and width ± 0.10 mm

The date code consists of: WW = 2 digit week,
Y = last digit of year, M = manufacturing site code

Notes:

1. All dimensions shown are typical in millimeters
2. An asterisk (*) in front of the marking code indicates prototype.

PCB Mounting Pattern

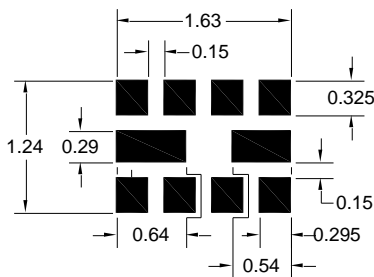

Notes:

1. All dimensions are in millimeters. Angles are in degrees.
2. This drawing specifies the mounting pattern used on the TriQuint evaluation board for this product. Some modification may be necessary to suit end user assembly materials and processes.

Tape and Reel information

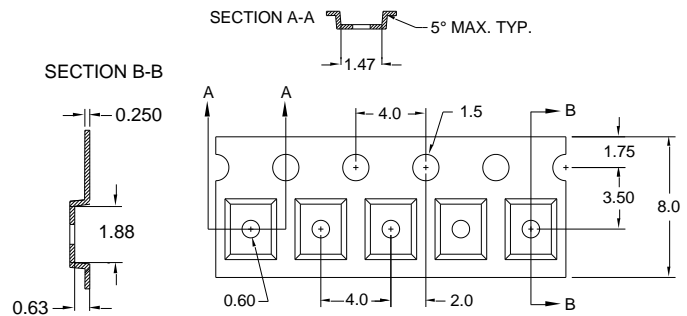
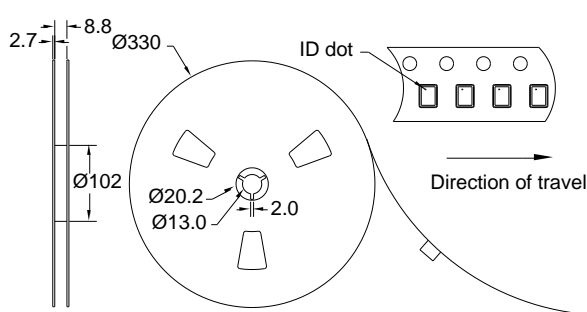

Standard T/R size=10,000 units/reel. All dimensions are in millimeters.

Product Compliance Information

ESD Sensitivity Ratings



Caution! ESD-Sensitive Device

ESD Rating: 3A

Value: Passes $\geq 4000V$ min.
Test: Human Body Model (HBM)
Standard: JEDEC Standard JESD22-A114

ESD Rating: C

Value: Passes $\geq 1700 V$ min.
Test: Machine Model (MM)
Standard: JEDEC Standard JESD22-A115

MSL Rating

Not applicable. Hermetic package.

Solderability

Compatible with the latest version of J-STD-020, lead free solder, 260°C

Refer to [Soldering Profile](#) for recommended guidelines.

RoHs Compliance

This part is compliant with EU 2002/95/EC RoHS directive (Restrictions on the Use of Certain Hazardous Substances in Electrical and Electronic Equipment).

This product also has the following attributes:

- Halogen Free (Chlorine, Bromine)
- Antimony Free
- TBBP-A (C₁₅H₁₂Br₄O₂) Free
- PFOS Free
- SVHC Free

Contact Information

For the latest specifications, additional product information, worldwide sales and distribution locations, and information about TriQuint:

Web: www.triquint.com
Email: info-sales@tqs.com

Tel: +1.407.886.8860
Fax: +1.407.886.7061

For technical questions and application information: Email: flapplication.engineering@tqs.com

Important Notice

The information contained herein is believed to be reliable. TriQuint makes no warranties regarding the information contained herein. TriQuint assumes no responsibility or liability whatsoever for any of the information contained herein. TriQuint assumes no responsibility or liability whatsoever for the use of the information contained herein. The information contained herein is provided "AS IS, WHERE IS" and with all faults, and the entire risk associated with such information is entirely with the user. All information contained herein is subject to change without notice. Customers should obtain and verify the latest relevant information before placing orders for TriQuint products. The information contained herein or any use of such information does not grant, explicitly or implicitly, to any party any patent rights, licenses, or any other intellectual property rights, whether with regard to such information itself or anything described by such information.

TriQuint products are not warranted or authorized for use as critical components in medical, life-saving, or life-sustaining applications, or other applications where a failure would reasonably be expected to cause severe personal injury or death.