

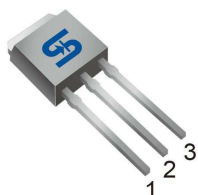

TO-251
(IPAK)



TO-252
(DPAK)



Pin Definition:

1. Base
2. Collector
3. Emitter

PRODUCT SUMMARY

BV_{CEO}	400V
BV_{CBO}	700V
I_C	3A
$V_{CE(SAT)}$	0.17V @ $I_C=1A, I_B=0.25A$

Features

- Build-in Free-wheeling Diode Makes Efficient Anti-saturation Operation
- No Need to Interest an hfe Value Because of Low Variable Storage-time Spread Even Though Corner Spirit Product.
- Low Base Drive Requirement
- Suitable for Half Bridge Light Ballast Application

Structure

- Silicon Triple Diffused Type
- NPN Silicon Transistor
- Integrated Anti-parallel Collector-Emitter Diode

Block Diagram

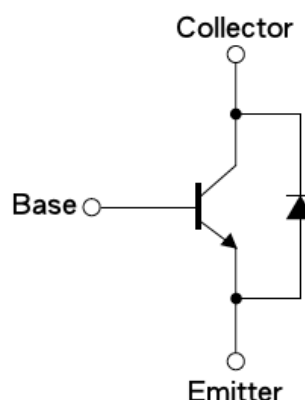

Ordering Information

Part No.	Package	Packing
TSC5303DCP RO	TO-252	2.5Kpcs / 13" Reel
TSC5303DCH C5	TO-251	75pcs / Tube

Absolute Maximum Rating ($T_a = 25^{\circ}C$ unless otherwise noted)

Parameter	Symbol	Limit	Unit
Collector-Base Voltage	V_{CBO}	700	V
Collector-Emitter Voltage @ $V_{BE}=0V$	V_{CES}	700	V
Collector-Emitter Voltage	V_{CEO}	400	V
Emitter-Base Voltage	V_{EBO}	9	V
Collector Current	I_C	3	A
Collector Peak Current ($t_p < 5ms$)	I_{CM}	6	A
Base Current	I_B	1.5	A
Base Peak Current ($t_p < 5ms$)	I_{BM}	3	A
Power Total Dissipation @ $T_c=25^{\circ}C$	P_{DTOT}	30	W
Maximum Operating Junction Temperature	T_J	+150	$^{\circ}C$
Storage Temperature Range	T_{STG}	-55 to +150	$^{\circ}C$

Thermal Performance

Parameter	Symbol	Limit	Unit
Thermal Resistance - Junction to Case	$R_{\theta_{JC}}$	4.15	$^{\circ}\text{C/W}$
Thermal Resistance - Junction to Ambient	$R_{\theta_{JA}}$	75	$^{\circ}\text{C/W}$

Electrical Specifications (Ta = 25 $^{\circ}\text{C}$ unless otherwise noted)

Parameter	Conditions	Symbol	Min	Typ	Max	Unit
Static						
Collector-Base Voltage	$I_C = 1\text{mA}, I_B = 0$	BV_{CBO}	700	--	--	V
Collector-Emitter Breakdown Voltage	$I_C = 10\text{mA}, I_E = 0$	BV_{CEO}	400	--	--	V
Emitter-Base Breakdown Voltage	$I_E = 1\text{mA}, I_C = 0$	BV_{EBO}	9	--	--	V
Collector Cutoff Current	$V_{CB} = 700\text{V}, I_E = 0$	I_{CBO}	--	--	10	μA
Collector Cutoff Current	$V_{CE} = 400\text{V}, I_B = 0$	I_{CEO}	--	--	10	μA
Emitter Cutoff Current	$V_{EB} = 7\text{V}, I_C = 0$	I_{EBO}	--	--	10	μA
Collector-Emitter Saturation Voltage	$I_C = 0.4\text{A}, I_B = 0.1\text{A}$	$V_{CE(SAT)1}$	--	0.10	0.7	V
	$I_C = 1\text{A}, I_B = 0.25\text{A}$	$V_{CE(SAT)2}$	--	0.17	1	
	$I_C = 2\text{A}, I_B = 0.5\text{A}$	$V_{CE(SAT)3}$	--	0.55	--	
Base-Emitter Saturation Voltage	$I_C = 1\text{A}, I_B = 0.25\text{A}$	$V_{BE(SAT)1}$	--	--	1.1	V
	$I_C = 2\text{A}, I_B = 0.5\text{A}$	$V_{BE(SAT)2}$	--	--	1.2	
DC Current Gain	$V_{CE} = 5\text{V}, I_C = 10\text{mA}$	Hfe	10	--	--	
	$V_{CE} = 5\text{V}, I_C = 1\text{A}$		15	--	30	
	$V_{CE} = 5\text{V}, I_C = 2\text{A}$		5	--	--	
Forward Voltage Drop	$I_F = 2\text{A}$	Vf	--	--	2	V
Turn On Time	$V_{CC} = 250\text{V}, I_C = 1\text{A},$	t_{ON}	--	0.2	0.6	μS
Storage Time	$I_{B1} = I_{B2} = 0.2\text{A}, t_p = 25\mu\text{S}$	t_{STG}	--	2.7	4.5	μS
Fall Time	Duty Cycle < 1%	t_f	--	0.16	0.3	μS

Notes: Pulsed duration = 380 μS , duty cycle $\leq 2\%$

Electrical Characteristics Curve (Ta = 25°C, unless otherwise noted)

Figure 1. Static Characteristics

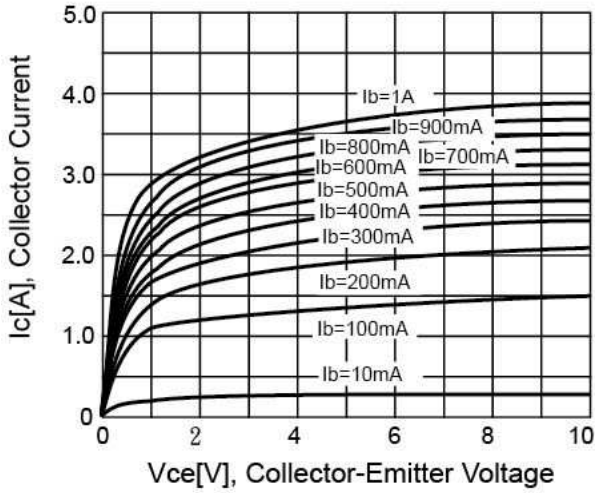

Figure 2. DC Current Gain

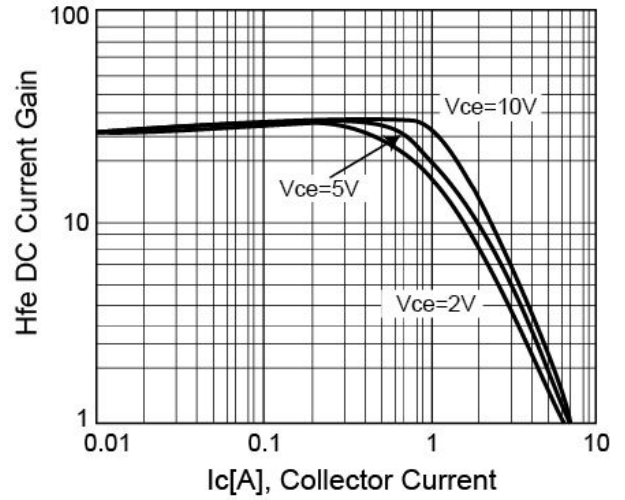

Figure 3. Vce(sat) v.s. Vbe(sat)

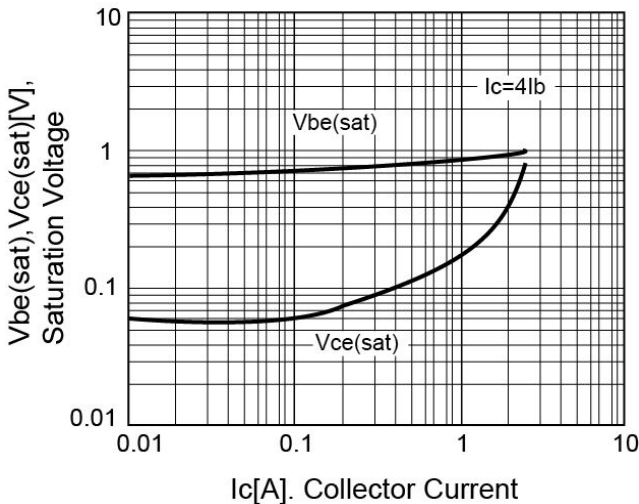

Figure 4. Power Derating

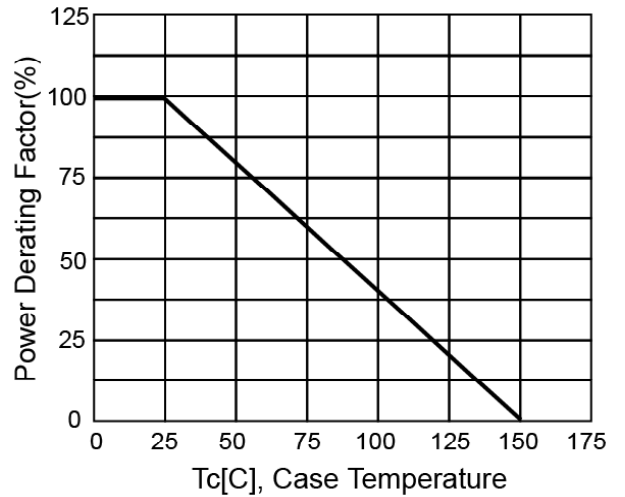

Figure 5. Reverse Bias SOA

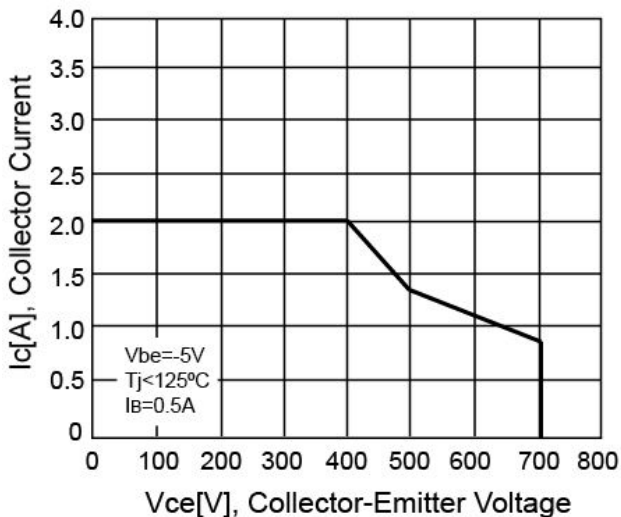
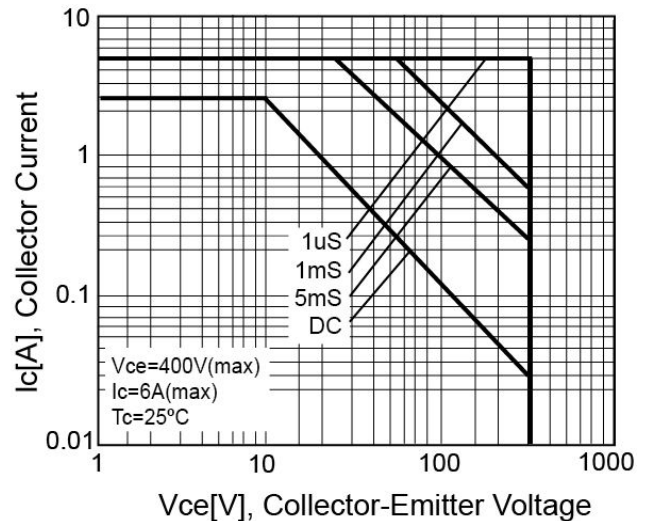
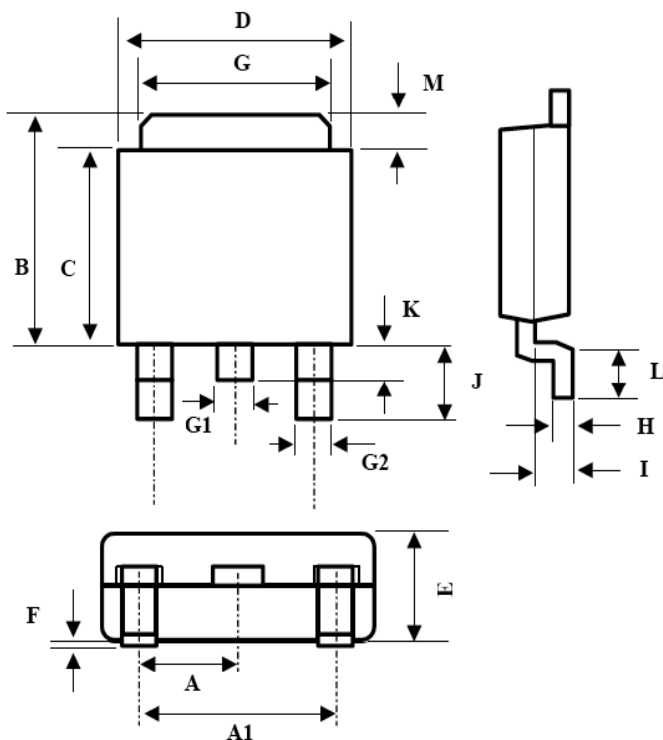

Figure 6. Safety Operating Area



TO-252 Mechanical Drawing



TO-252 DIMENSION				
DIM	MILLIMETERS		INCHES	
	MIN	MAX	MIN	MAX
A	2.290 BSC		0.090 BSC	
A1	4.600 BSC		0.180 BSC	
B	7.000	7.200	0.275	0.283
C	6.000	6.200	0.236	0.244
D	6.400	6.604	0.252	0.260
E	2.210	2.387	0.087	0.094
F	0.010	0.127	0.000	0.005
G	5.232	5.436	0.206	0.214
G1	0.666	0.889	0.026	0.035
G2	0.633	0.889	0.025	0.035
H	0.508 REF		0.020 REF	
I	0.900	1.500	0.035	0.059
J	2.743 REF		0.108 REF	
K	0.660	0.094	0.026	0.037
L	1.397	1.651	0.055	0.065
M	1.100 REF		0.043 REF	

Marking Diagram



- Y** = Year Code
- M** = Month Code
(**A**=Jan, **B**=Feb, **C**=Mar, **D**=Apr, **E**=May, **F**=Jun, **G**=Jul, **H**=Aug, **I**=Sep, **J**=Oct, **K**=Nov, **L**=Dec)
- L** = Lot Code

TO-251 Mechanical Drawing

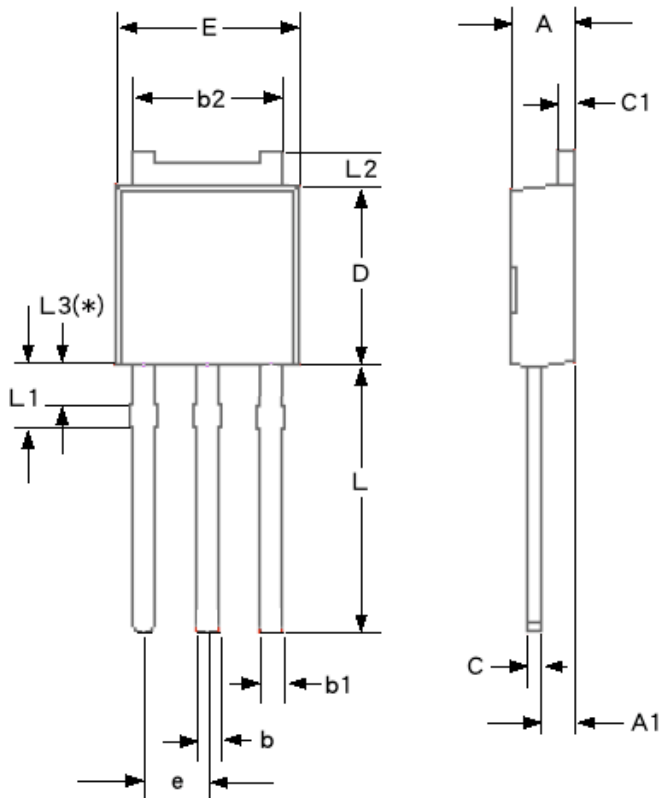

TO-251 DIMENSION				
DIM	MILLIMETERS		INCHES	
	MIN	MAX	MIN	MAX
A	2.190	2.380	0.0862	0.0937
A1	0.890	1.140	0.0350	0.0449
b	0.640	0.890	0.0252	0.0350
b1	0.760	1.140	0.0299	0.0449
b2	5.210	5.460	0.2051	0.2150
C	0.460	0.580	0.0181	0.0228
C1	0.460	0.580	0.0181	0.0228
D	5.970	6.100	0.2350	0.2402
E	6.350	6.730	0.2500	0.2650
e	2.280 BSC		0.0898 BSC	
L	8.890	9.650	0.3500	0.3799
L1	1.910	2.280	0.0752	0.0898
L2	0.890	1.270	0.0350	0.0500
L3	1.150	1.520	0.0453	0.0598

Marking Diagram

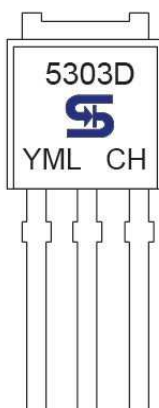

- Y** = Year Code
- M** = Month Code
(A=Jan, B=Feb, C=Mar, D=Apl, E=May, F=Jun, G=Jul, H=Aug, I=Sep, J=Oct, K=Nov, L=Dec)
- L** = Lot Code

Notice

Specifications of the products displayed herein are subject to change without notice. TSC or anyone on its behalf, assumes no responsibility or liability for any errors or inaccuracies.

Information contained herein is intended to provide a product description only. No license, express or implied, to any intellectual property rights is granted by this document. Except as provided in TSC's terms and conditions of sale for such products, TSC assumes no liability whatsoever, and disclaims any express or implied warranty, relating to sale and/or use of TSC products including liability or warranties relating to fitness for a particular purpose, merchantability, or infringement of any patent, copyright, or other intellectual property right.

The products shown herein are not designed for use in medical, life-saving, or life-sustaining applications. Customers using or selling these products for use in such applications do so at their own risk and agree to fully indemnify TSC for any damages resulting from such improper use or sale.