

Schottky Bridge Rectifiers

FEATURES

- Schottky technology
- Ideal for automated placement
- High surge current capability
- Moisture sensitivity: level 1, per J-STD-020
- Compliant to RoHS Directive 2011/65/EU and in accordance to WEEE 2002/96/EC
- Halogen-free according to IEC 61249-2-21 definition



ABS



MECHANICAL DATA

Case : Molded plastic body

Molding compound, UL flammability classification rating 94V-0
Base P/N with suffix "G" on packing code - halogen-free, RoHS compliant

Terminal : Matte tin plated leads, solderable per JESD22-B102
Meet JESD 201 class 1A whisker test

Polarity : Polarity as marked on the body

Weight : 0.09 gram (approximately)

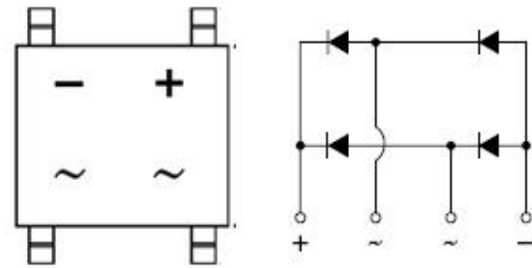

MAXIMUM RATINGS AND ELECTRICAL CHARACTERISTICS (T _A =25°C unless otherwise noted)			
PARAMETER	SYMBOL	SBS34	UNIT
Maximum repetitive peak reverse voltage	V _{RRM}	40	V
Maximum RMS voltage	V _{RMS}	28	V
Maximum DC blocking voltage	V _{DC}	40	V
Maximum average forward rectified current	I _{F(AV)}	3	A
Peak forward surge current, 8.3 ms single half sine-wave superimposed on rated load	I _{FSM}	80	A
Maximum instantaneous forward voltage (Note 1) IF= 3 A	V _F	0.50	V
Maximum DC reverse current at rated DC blocking voltage	I _R	0.5 10	mA
			T _A =25 °C T _A =100°C
Rating for fusing (t<8.3mS)	I ² T	26	A ² sec
Typical thermal resistance	R _{θJL} R _{θJA}	41 83	°C/W
Operating junction temperature range (Forward mode only)	T _J	- 55 to + 150	°C
Storage temperature range	T _{STG}	- 55 to + 150	°C

Note 1 : Pulse test with PW=300u sec, 1% duty cycle

ORDERING INFORMATION				
PART NO.	PACKING CODE	GREEN COMPOUND CODE	PACKAGE	PACKING
SBS34	RE	Suffix "G"	ABS	1000 / 7" Plastic reel
	RG		ABS	5000 / 13" Paper reel

Note : For ABS: Packing code (Whole series with green compound)

EXAMPLE				
PREFERRED P/N	PART NO.	PACKING CODE	GREEN COMPOUND CODE	DESCRIPTION
SBS34 REG	SBS34	RE	G	Green compound

RATINGS AND CHARACTERISTICS CURVES

(TA=25°C unless otherwise noted)

FIG.1 MAXIMUM FORWARD CURRENT DERATING CURVE

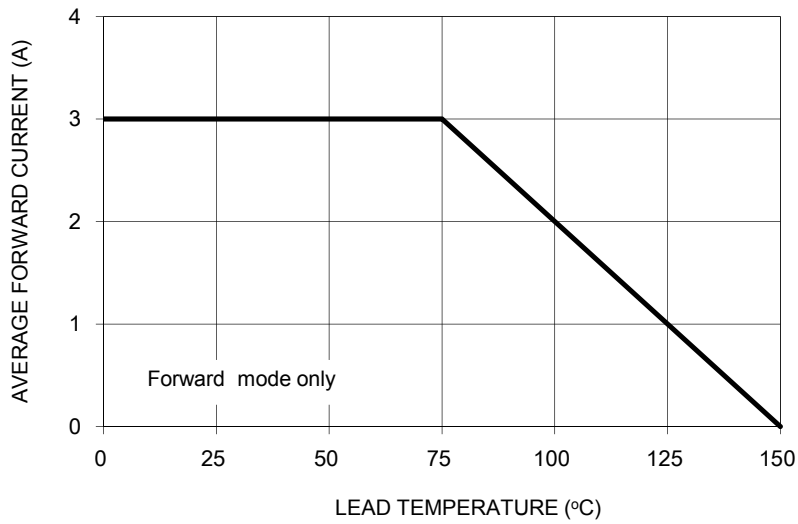

FIG. 2 TYPICAL REVERSE CHARACTERISTICS

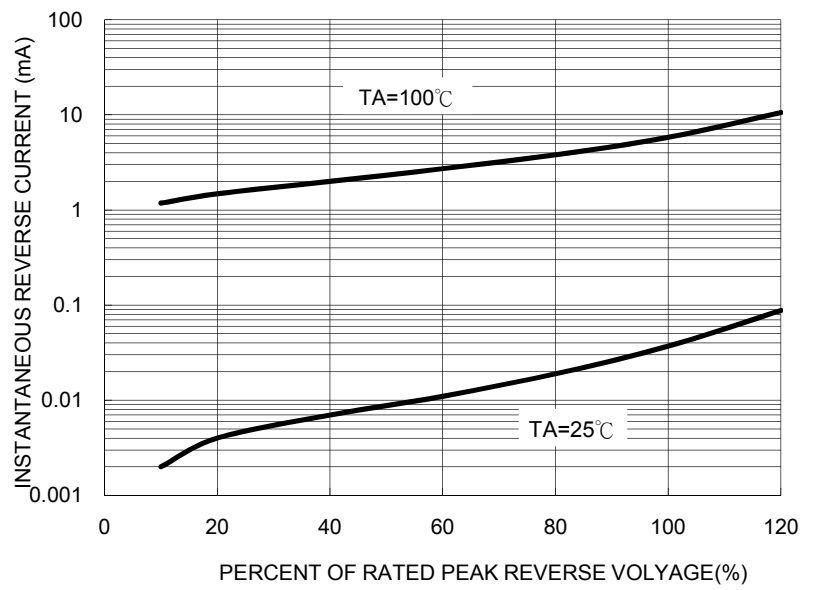

FIG. 3 MAXIMUM NON-REPETITIVE FORWARD SURGE CURRENT

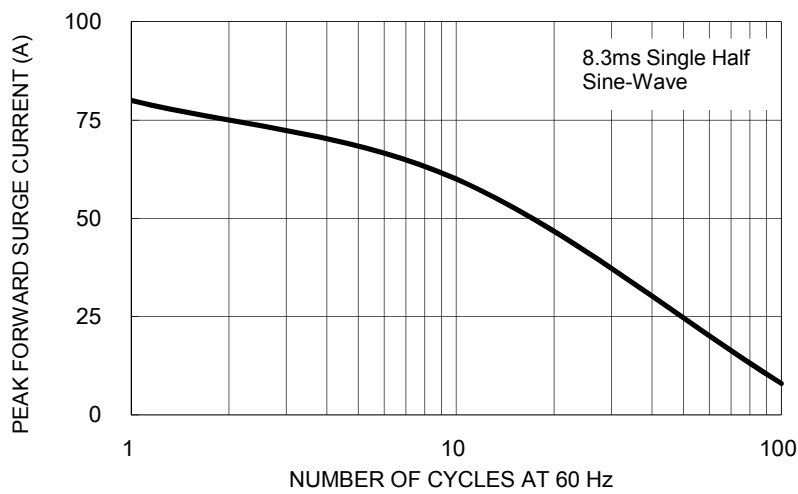

FIG. 4 TYPICAL JUNCTION CAPACITANCE

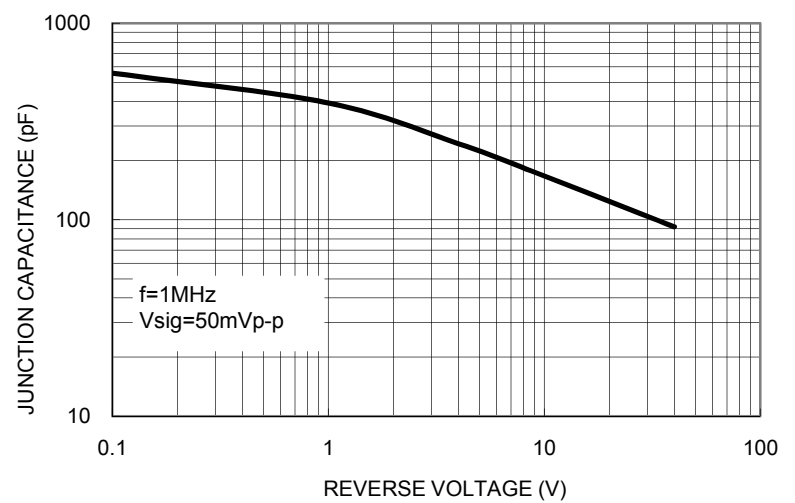
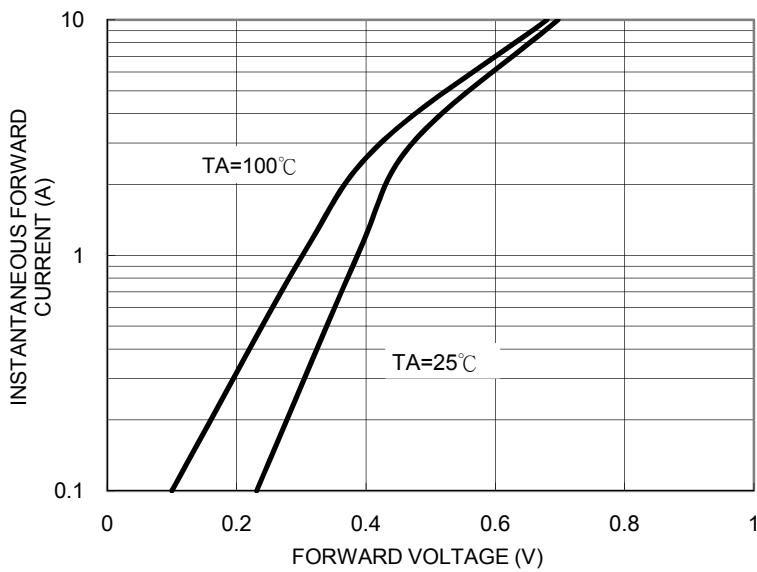
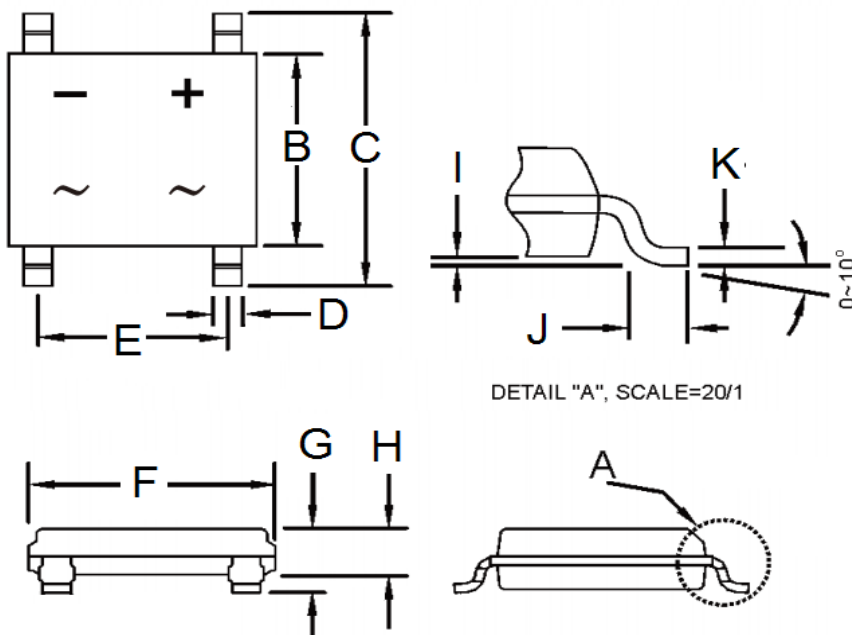

FIG. 5 TYPICAL FORWARD CHARACTERISTICS



PACKAGE OUTLINE DIMENSIONS



DIM.	Unit(mm)		Unit(inch)	
	Min	Max	Min	Max
B	4.30	4.50	0.169	0.177
C	6.25	6.65	0.246	0.262
D	0.60	0.70	0.024	0.028
E	3.90	4.10	0.154	0.161
F	4.90	5.10	0.193	0.200
G	1.40	1.60	0.055	0.063
H	1.35	1.45	0.053	0.057
I	0.05	0.15	0.002	0.006
J	0.30	0.70	0.012	0.028
K	0.15	0.25	0.006	0.010

SUGGESTED PAD LAYOUT

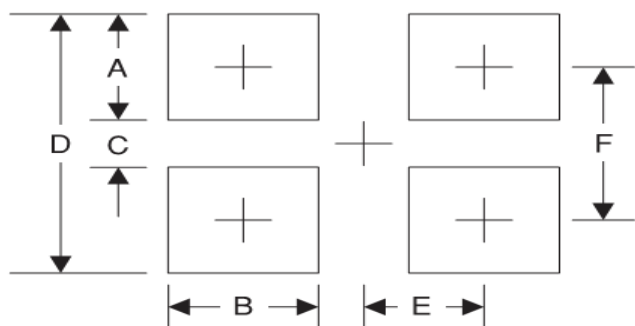

Symbol	Unit(mm)
A	1.5
B	0.9
C	4.22
D	7.22
E	2.05
F	5.72

MARKING DIAGRAM

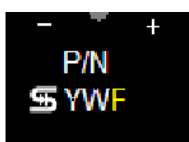

P/N = Specific Device Code
 YW = Date Code
 F = Factory Code