

Dual Differential Comparator

LM393Q8

Description

The LM393Q8 consists of two independent voltage comparators, designed specifically to operate from a single power over a wide voltage range.

Features

- Single or dual supply operation
- Wide operating supply range($V_{CC}=2V\sim 36V$ or $\pm 1V$ to $\pm 18V$)
- Input common-mode voltage includes ground
- Low supply current drain $I_{CC}=0.8mA$ (typical)
- Low input bias current $I_{bias}=25nA$ (typical)
- Output compatible with TTL, DTL and CMOS logic system

Pin Configurations

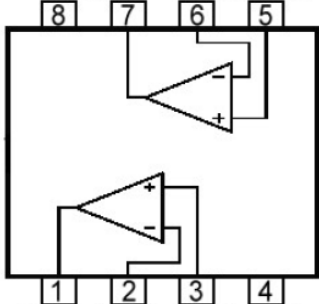
	Pin1: OUT 1	Pin5: IN 2 (+)
	Pin2: IN 1 (-)	Pin6: IN 2 (-)
	Pin3: IN 1 (+)	Pin7: OUT 2
	Pin4: Gnd	Pin8: VCC



Absolute Maximum Rating

Parameter	Symbol	Value	Unit
Supply Voltage	V _{CC}	±18 or 36	V
Differential Input Voltage	V _{IDiff}	36	V
Input Voltage	V _I	-0.3 ~ 36	V
Power Dissipation	P _D	570	mW
Operating Temperature	T _{opr}	-40 ~ +125	°C
Storage Temperature	T _{stg}	-65 ~ +150	°C

Electrical Characteristics (V_{CC}=5V, T_a=25°C, R_T=10k, all voltage referenced to ground unless otherwise specified.)

Parameter	Test Condition	Symbol	Min.	Typ.	Max.	Unit
Input Offset Voltage	V _{CM} =0 to V _{CC} -1.5 V _{O(p)} =1.4V, R _S =0	V _{IO}	-	±1	±5	mV
Input Offset Current		I _{IO}	-	±5	±50	nA
Input Bias Current		I _b	-	65	250	nA
Input Common-Mode Voltage Range		V _{I(R)}	0	-	V _{CC} -1.5	V
Supply Current	R _L =∞	I _{CC}	-	0.6	1.0	mA
	R _L =∞, V _{CC} =30V		-	0.8	2.5	mA
Large Signal Voltage Gain	V _{CC} =15V, R _L >15kΩ	G _v	50	200	-	V/mV
Large Signal Response Time	V _i =TTL logic wing V _{ref} =1.4V, V _{RL} =5V R _L =5.1kΩ	t _{res}	-	350	-	ns
Response Time	V _{RL} =5V, R _L =5.1kΩ	t _{res}	-	1400	-	ns
Output Sink Current	V _{i(-)} >1V, V _{i(+)} =0V, V _{O(p)} <1.5V	I _{sink}	6	18	-	mA
Output Saturation Voltage	V _{i(-)} >1V, V _{i(+)} =0V, I _{sink} =4mA	V _{sat}	-	160	400	mV
Output Leakage Current	V _{I(+)} =1V, V _{I(-)} =0, V _{O(p)} =5V V _{O(p)} =30V	I _{leakage}	-	0.1	-	nA
			-	-	1.0	μA

Block Diagram

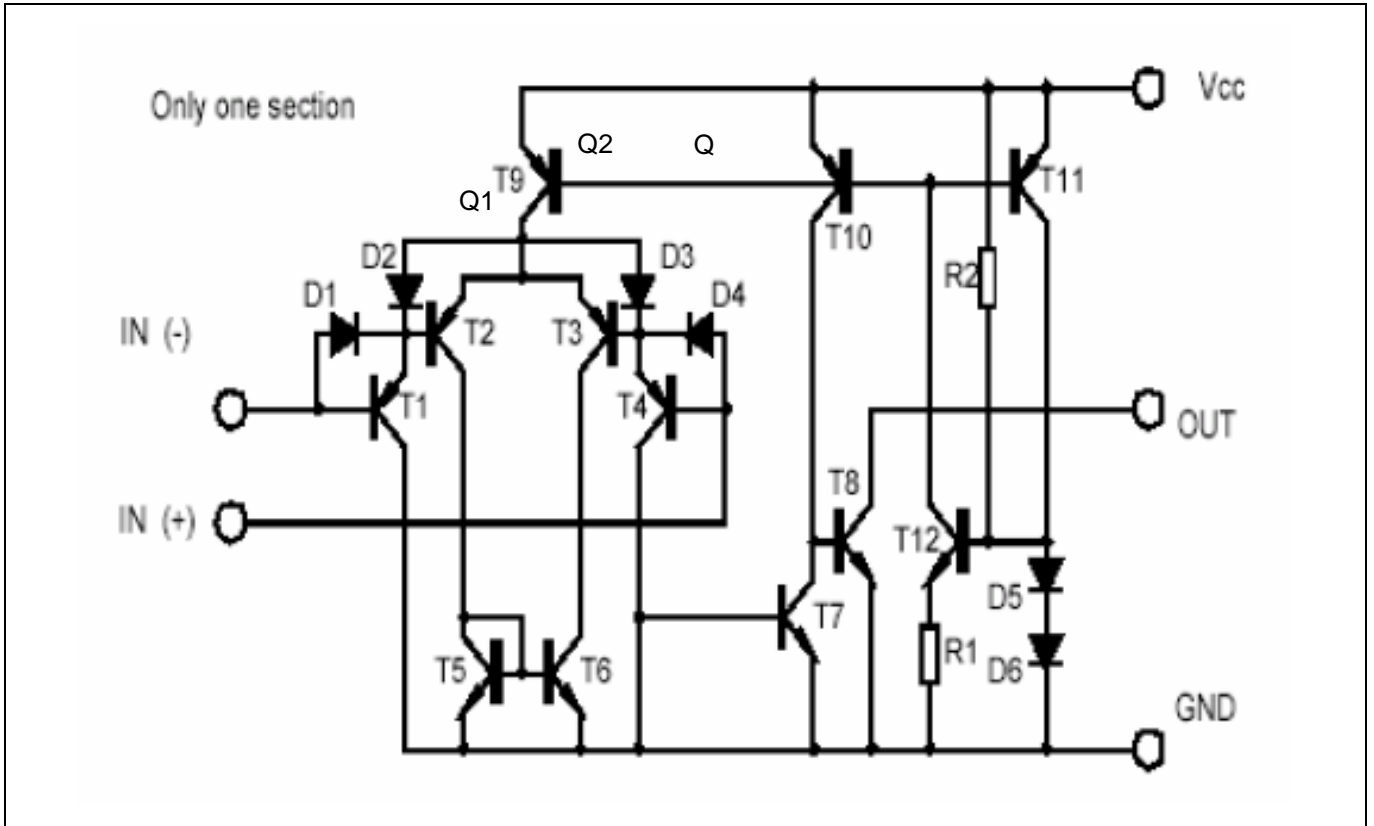

Characteristic Curves

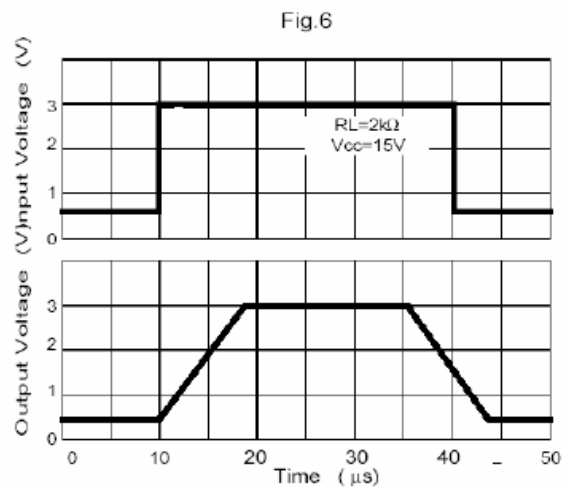
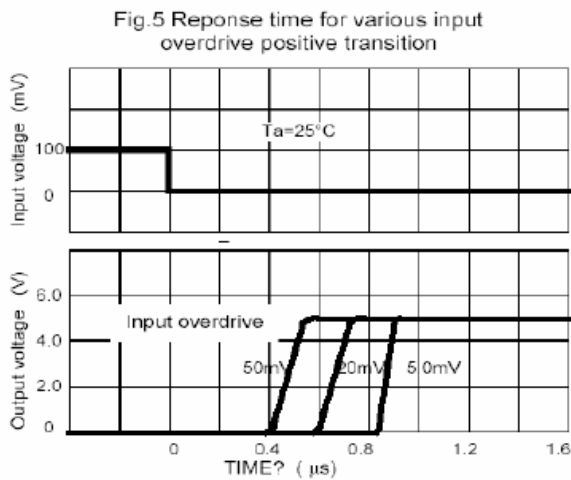
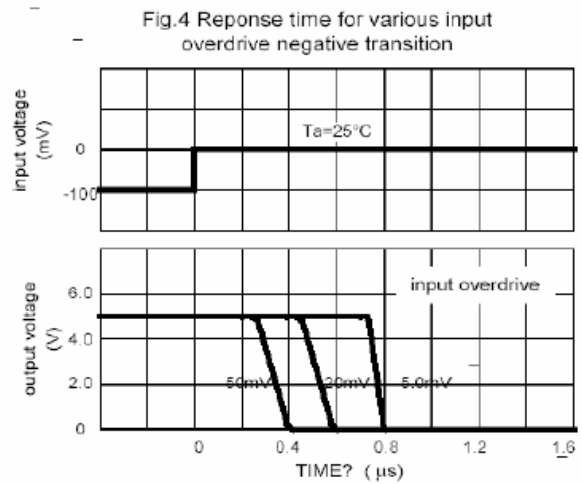
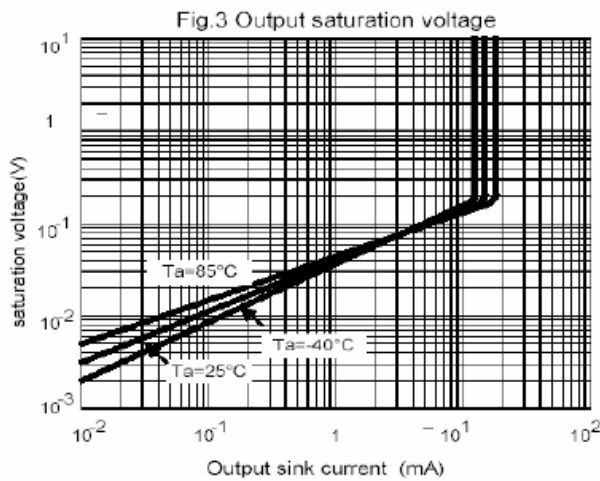
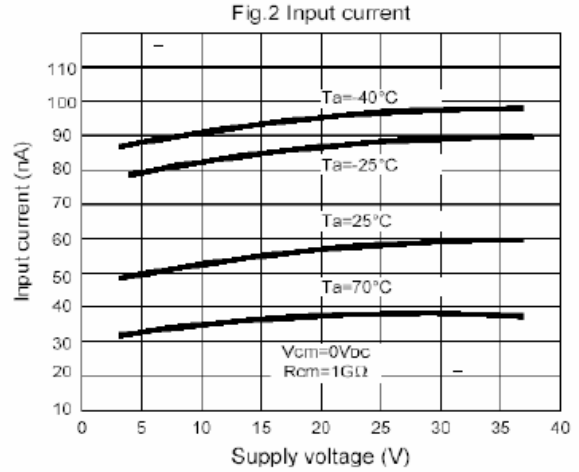
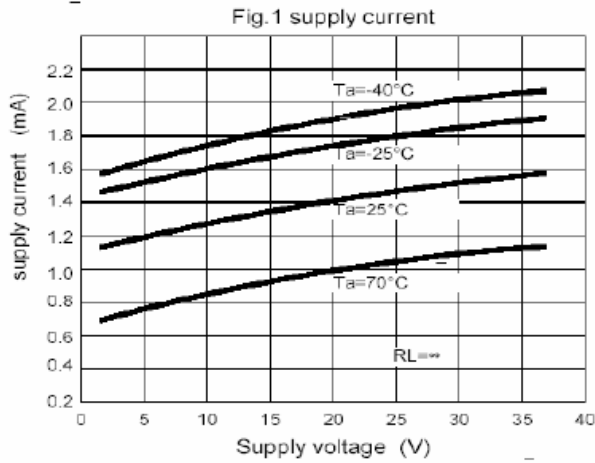

Characteristic Curves(Cont.)

Fig.7 voltage Follower pulse response (small signal)

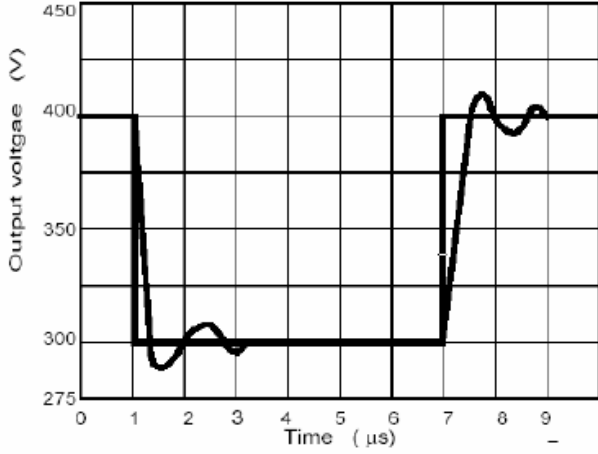

Fig.8 Large signal Frequency Response

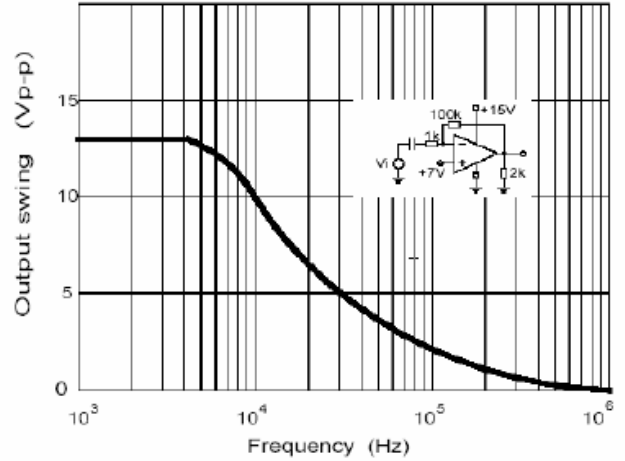

Fig.9 Output Characteristics current sourcing

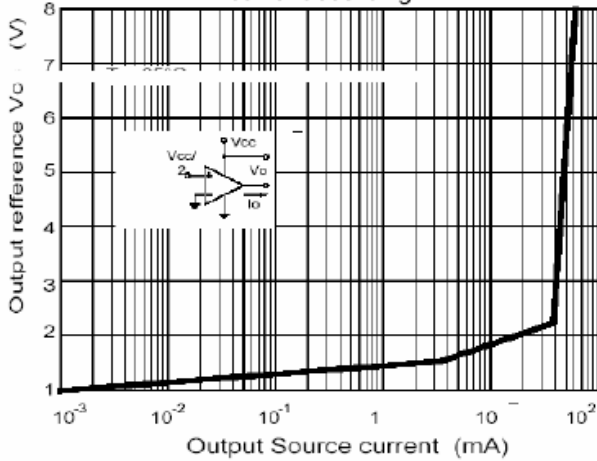

Fig.10 Output Characteristics Current sinking

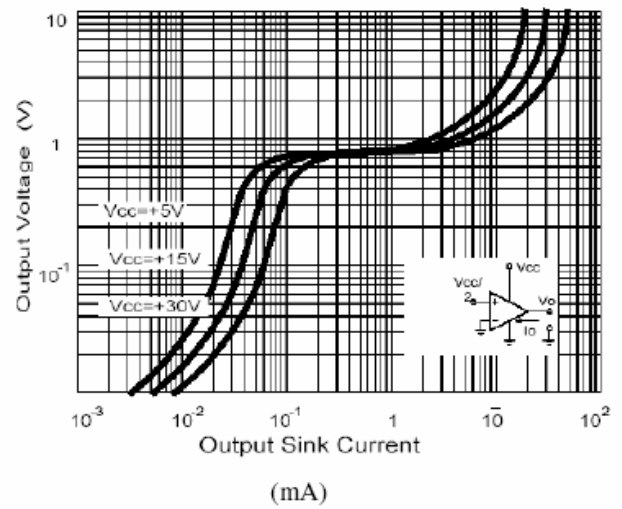
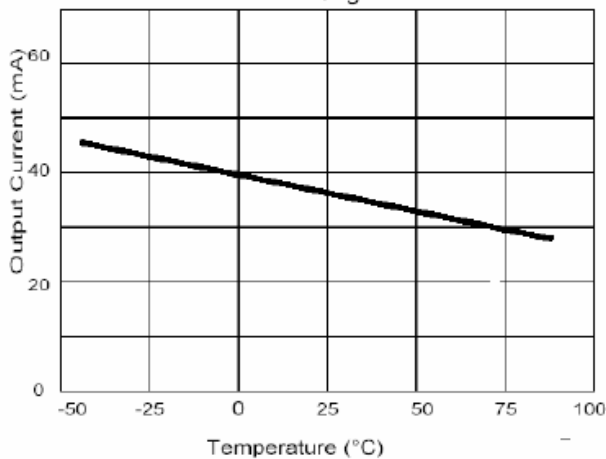
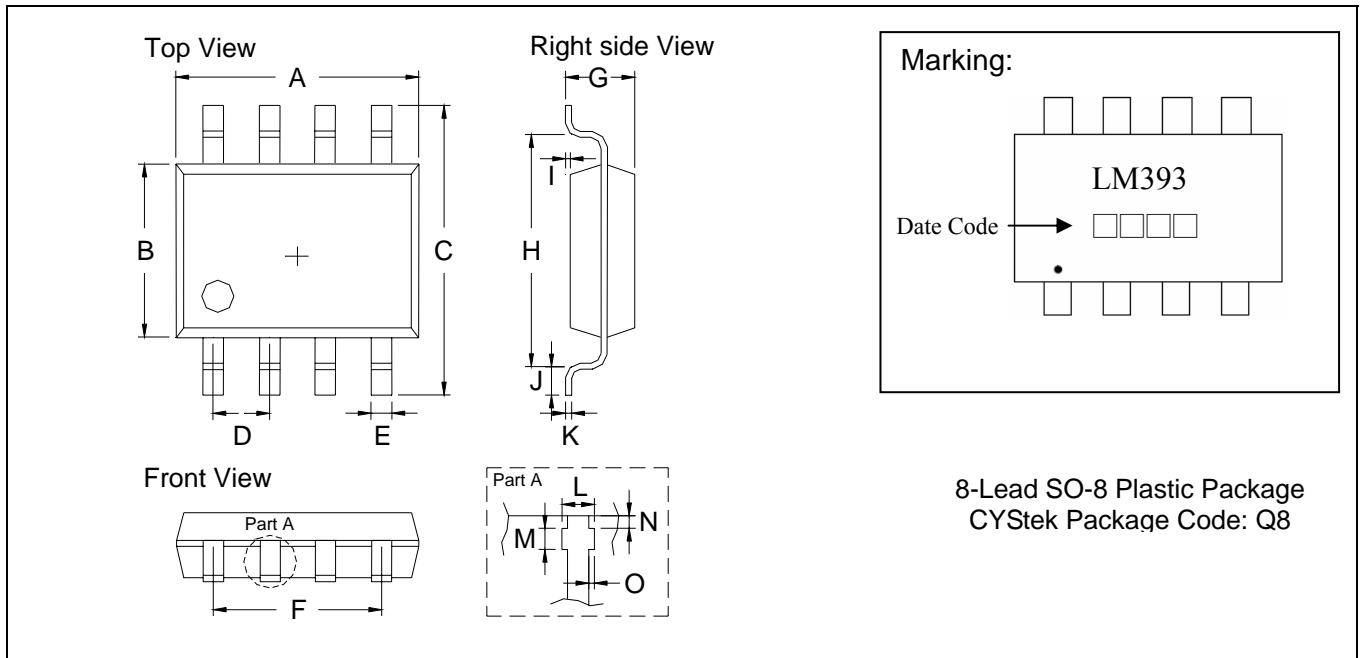

Fig.11 Current Limiting



SO-8 Dimension



*: Typical

DIM	Inches		Millimeters		DIM	Inches		Millimeters	
	Min.	Max.	Min.	Max.		Min.	Max.	Min.	Max.
A	0.1909	0.2007	4.85	5.10	I	0.0019	0.0078	0.05	0.20
B	0.1515	0.1555	3.85	3.95	J	0.0118	0.0275	0.30	0.70
C	0.2283	0.2441	5.80	6.20	K	0.0074	0.0098	0.19	0.25
D	0.0480	0.0519	1.22	1.32	L	0.0145	0.0204	0.37	0.52
E	0.0145	0.0185	0.37	0.47	M	0.0118	0.0197	0.30	0.50
F	0.1472	0.1527	3.74	3.88	N	0.0031	0.0051	0.08	0.13
G	0.0570	0.0649	1.45	1.65	O	0.0000	0.0059	0.00	0.15
H	0.1889	0.2007	4.80	5.10					

Notes: 1. Controlling dimension: millimeters.
 2. Maximum lead thickness includes lead finish thickness, and minimum lead thickness is the minimum thickness of base material.
 3. If there is any question with packing specification or packing method, please contact your local CYStek sales office.

Material:

- Lead: Pure tin plated.
- Mold Compound: Epoxy resin family, flammability solid burning class: UL94V-0.

Important Notice:

- All rights are reserved. Reproduction in whole or in part is prohibited without the prior written approval of CYStek.
- CYStek reserves the right to make changes to its products without notice.
- CYStek **semiconductor products are not warranted to be suitable for use in Life-Support Applications, or systems.**
- CYStek assumes no liability for any consequence of customer product design, infringement of patents, or application assistance.