

Dual Series Switching Diodes

Features

- We declare that the material of product compliance with RoHS requirements.
- S- Prefix for Automotive and Other Applications Requiring Unique Site and Control Change Requirements; AEC-Q101 Qualified and PPAP Capable.
- The LBAV99WT1G is a smaller package, equivalent to the LBAV99LT1G.

Suggested Applications

- ESD Protection
- Polarity Reversal Protection
- Data Line Protection
- Inductive Load Protection
- Steering Logic

ORDERING INFORMATION

Device	Package	Shipping
LBAV99WT1G S-LBAV99WT1G	SOT-323(SC-70)	3000/Tape & Reel
LBAV99RWT1G S-LBAV99RWT1G	SOT-323(SC-70)	3000/Tape & Reel
LBAV99WT3G S-LBAV99WT3G	SOT-323(SC-70)	10000/Tape & Reel
LBAV99RWT3G S-LBAV99RWT3G	SOT-323(SC-70)	10000/Tape & Reel

DEVICE MARKING

LBAV99WT1G = A7; LBAV99RWT1G = F7

MAXIMUM RATINGS (Each Diode)

Rating	Symbol	Value	Unit
Reverse Voltage	V_R	70	Vdc
Forward Current	I_F	215	mAdc
Peak Forward Surge Current	$I_{FM(surge)}$	500	mAdc
Repetitive Peak Reverse Voltage	V_{RRM}	70	V
Average Rectified Forward Current (Note 1.) (averaged over any 20 ms period)	$I_{F(AV)}$	715	mA
Repetitive Peak Forward Current	I_{FRM}	450	mA
Non-Repetitive Peak Forward Current	I_{FSM}		A
t = 1.0 μ s		2.0	
t = 1.0 ms		1.0	
t = 1.0 S		0.5	

1. FR-5 = 1.0 × 0.75 × 0.062 in.

LBAV99WT1G
S-LBAV99WT1G
LBAV99RWT1G
S-LBAV99RWT1G



LBAV99WT1G
SOT-323 (SC-70)

LBAV99RWT1G
SOT-323 (SC-70)

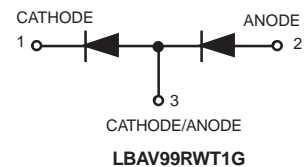
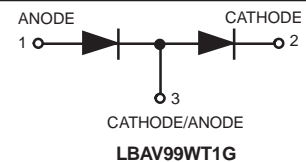

LBAV99WT1G,S-LBAV99WT1G LBAV99RWT1G,S-LBAV99RWT1G

THERMAL CHARACTERISTICS

3

Characteristic	Symbol	Max	Unit
Total Device Dissipation FR-5 Board, (Note 1.) $T_A = 25^\circ\text{C}$ Derate above 25°C	P_D	200	mW
Thermal Resistance Junction to Ambient	$R_{\theta JA}$	625	$^\circ\text{C/W}$
Total Device Dissipation Alumina Substrate, (Note 2.) $T_A = 25^\circ\text{C}$ Derate above 25°C	P_D	300	mW
Thermal Resistance Junction to Ambient	$R_{\theta JA}$	417	$^\circ\text{C/W}$
Junction and Storage Temperature	T_J, T_{stg}	-65 to +150	$^\circ\text{C}$

ELECTRICAL CHARACTERISTICS ($T_A = 25^\circ\text{C}$ unless otherwise noted) (Each Diode)

Characteristic	Symbol	Min	Max	Unit
----------------	--------	-----	-----	------

OFF CHARACTERISTICS

Reverse Breakdown Voltage ($I_{BR} = 100 \mu\text{A}$)	$V_{(BR)}$	70	—	Vdc
Reverse Voltage Leakage Current ($V_R = 70 \text{ Vdc}$) ($V_R = 25 \text{ Vdc}, T_J = 150^\circ\text{C}$) ($V_R = 70 \text{ Vdc}, T_J = 150^\circ\text{C}$)	I_R	—	2.5 30 50	μAdc
Diode Capacitance ($V_R = 0, f = 1.0 \text{ MHz}$)	C_D	—	1.5	pF
Forward Voltage ($I_F = 1.0 \text{ mAdc}$) ($I_F = 10 \text{ mAdc}$) ($I_F = 50 \text{ mAdc}$) ($I_F = 150 \text{ mAdc}$)	V_F	—	715 855 1000 1250	mVdc
Reverse Recovery Time ($I_F = I_R = 10 \text{ mAdc}, i_{R(REC)} = 1.0 \text{ mAdc}$) (Figure 1)	t_{rr}	—	6.0	ns
Forward Recovery Voltage ($I_F = 10 \text{ mA}, t_r = 20 \text{ ns}$)	V_{FR}	—	1.75	V

1. FR-5 = $1.0 \times 0.75 \times 0.062 \text{ in.}$

2. Alumina = $0.4 \times 0.3 \times 0.024 \text{ in.}$ 99.5% alumina.

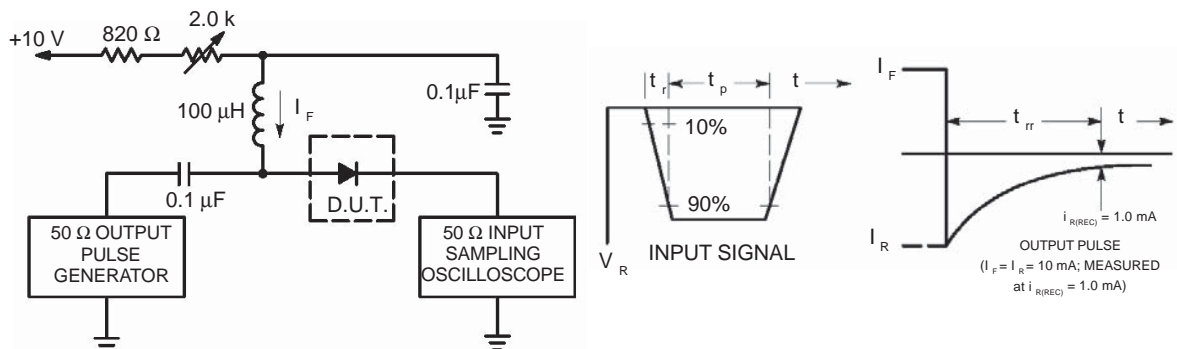

Notes: 1. A 2.0 kΩ variable resistor adjusted for a Forward Current (I_F) of 10mA.

2. Input pulse is adjusted so $I_{R(\text{peak})}$ is equal to 10mA.

3. $t_p \gg t_{rr}$

Figure 1. Recovery Time Equivalent Test Circuit

LBAV99WT1G,S-LBAV99WT1G
LBAV99RWT1G,S-LBAV99RWT1G

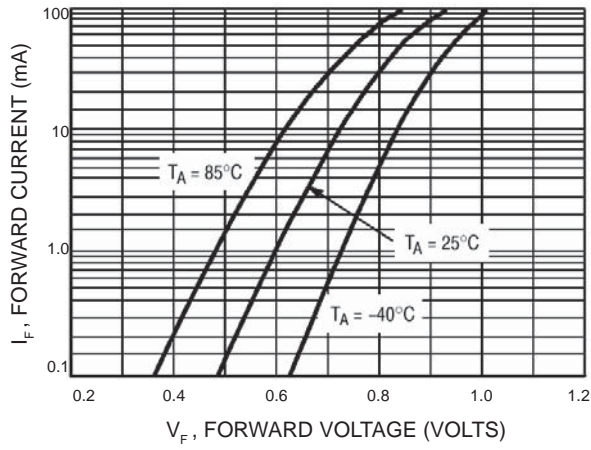

Figure 2. Forward Voltage

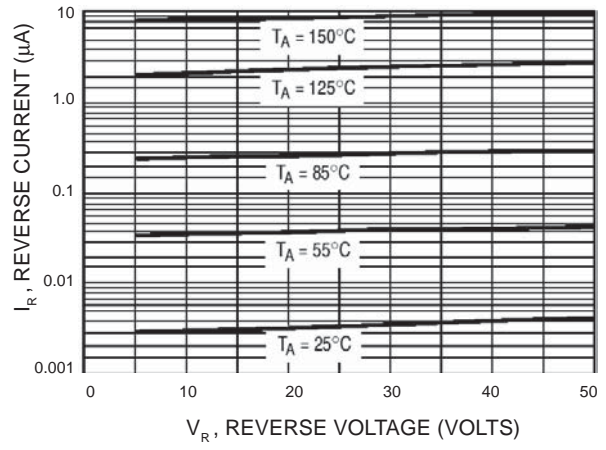

Figure 3. Leakage Current

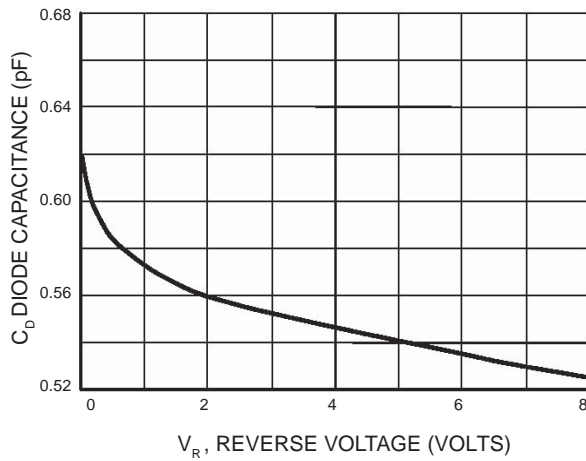
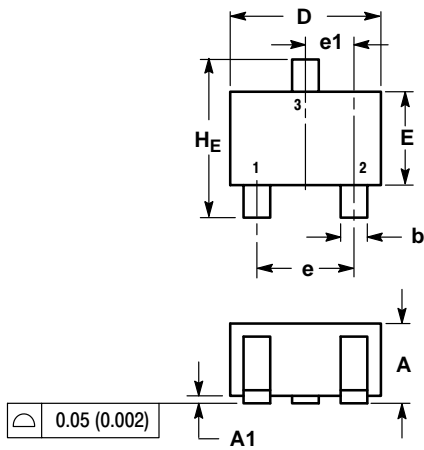

Figure 4. Capacitance

**LBAV99WT1G,S-LBAV99WT1G
LBAV99RWT1G,S-LBAV99RWT1G**
SC-70 (SOT-323)

DIM	MILLIMETERS			INCHES		
	MIN	NOM	MAX	MIN	NOM	MAX
A	0.80	0.90	1.00	0.032	0.035	0.040
A1	0.00	0.05	0.10	0.000	0.002	0.004
A2	0.7 REF			0.028 REF		
b	0.30	0.35	0.40	0.012	0.014	0.016
c	0.10	0.18	0.25	0.004	0.007	0.010
D	1.80	2.10	2.20	0.071	0.083	0.087
E	1.15	1.24	1.35	0.045	0.049	0.053
e	1.20	1.30	1.40	0.047	0.051	0.055
e1	0.65 BSC			0.026 BSC		
L	0.425 REF			0.017 REF		
HE	2.00	2.10	2.40	0.079	0.083	0.095

SOLDERING FOOTPRINT*
