

## SUPER FLUX LED LAMP, 4PIN LED

BL-FL7670xx

### Features:

- Ø 7.62\*7.62\*4.0MM, 3MM ROUND SUPER FLUX LED LAMP
- Ø Ultra brightness.
- Ø Wide Viewing Angles.
- Ø Ideal For Backlight and Indicator
- Ø RoHs Compliance



### Electrical-optical characteristics: (Ta=25°C) (Test Condition: IF=20mA)

Part Number	Chip			Lens Type	Forward Voltage(VF) Unit:V		Luminous Intensity (lv) Unit:mcd		Viewing Angle 2θ/2 (deg)
	Emitted Color	Material	λ <sub>p</sub> (nm)		Typ	Max	Min.	Typ.	
					BL-FL7670URC	Ultra Red	AlGaAs,DDH	660	
BL-FL7670UEC	Ultra Orange	AlGaInP	630	2.10	2.50	800	1600		
BL-FL7670UYC	Ultra Yellow	AlGaInP	590	2.10	2.50	600	1400		
BL-FL7670UGC	Ultra Green	AlGaInP	574	2.20	2.50	200	800		
BL-FL7670PGC	Ultra Pure Green	InGaN	525	3.80	4.50	1000	5200		
BL-FL7670BGC	Ultra Bluish Green	InGaN	505	3.80	4.50	800	4200		
BL-FL7670UBC	Ultra Blue	InGaN	470	2.70	4.20	800	2200		
BL-FL7670UWC	Ultra White	InGaN	/	2.70	4.20	1000	5200		

### Absolute maximum ratings (Ta=25°C)

Parameter	UR	UE	UY	UG	PG	BG	UB	W	Unit
Forward Current I <sub>F</sub>	25	30	30	30	30	30	30	30	mA
Power Dissipation P <sub>d</sub>	60	65	65	75	110	110	120	120	mW
Reverse Voltage V <sub>R</sub>	5	5	5	5	5	5	5	5	V
Peak Forward Current I <sub>PF</sub> (Duty 1/10 @1KHZ)	150	150	150	150	150	100	100	100	mA
Operation Temperature T <sub>OPR</sub>	-40 to +80								°C
Storage Temperature T <sub>STG</sub>	-40 to +85								°C
Lead Soldering Temperature T <sub>SOL</sub>	Max.260±5°C for 3 sec Max. (1.6mm from the base of the epoxy bulb)								°C

**SUPER FLUX LED LAMP, 4PIN LED**

BL-FL7670xx

**Package configuration & Internal circuit diagram**

**BL-LF7670 Series**

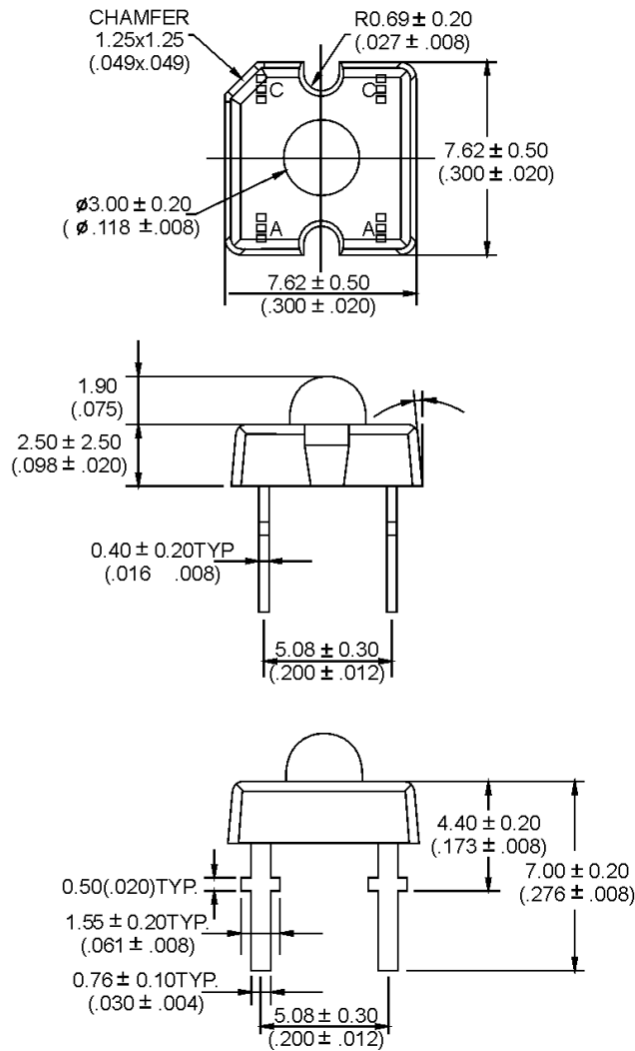

**Notes:**

1. All dimensions are in millimeters (inches)
2. Tolerance is ±0.25(0.01") unless otherwise noted.
3. Specifications are subject to change without notice.

# SUPER FLUX LED LAMP, 4PIN LED

BL-FL7670xx

## Typical electrical-optical characteristics curves:

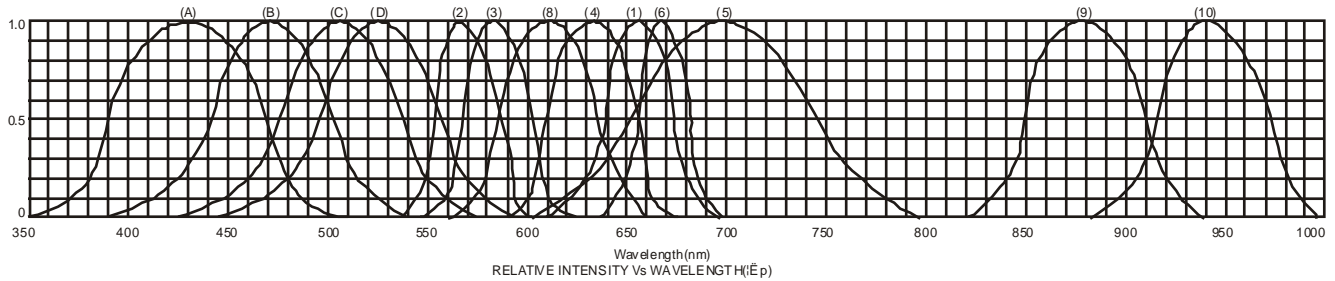

- (1) - GaAsP/GaAs 655nm/Red
- (2) - GaP 570nm/Yellow Green
- (3) - GaAsP/GaP 585nm/Yellow
- (4) - GaAsP/GaP 635nm/Orange & Hi-Eff Red
- (5) - GaP 700nm/Bright Red
- (6) - GaAlAs/GaAs 660nm/Super Red
- (8) - GaAsP/GaP 610nm/Super Red
- (9) - GaAlAs 880nm
- (10) - GaAs/GaAs & GaAlAs/GaAs 940nm
- (A) - GaN/SiC 430nm/Blue
- (B) - InGaN/SiC 470nm/Blue
- (C) - InGaN/SiC 505nm/Ultra Green
- (D) - InGaAlSiC 525nm/Ultra Green

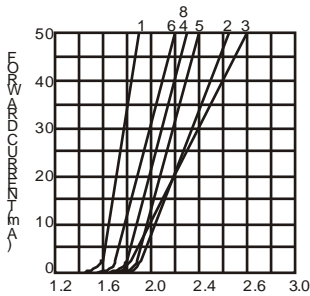

FORWARD VOLTAGE (Vf)  
FORWARD CURRENT VS.  
FORWARD VOLTAGE

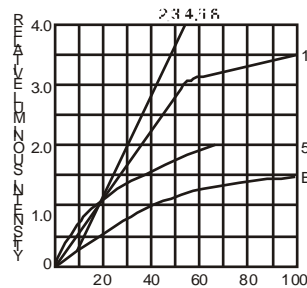

FORWARD CURRENT (mA)  
RELATIVE LUMINOUS  
INTENSITY VS. FORWARD  
CURRENT

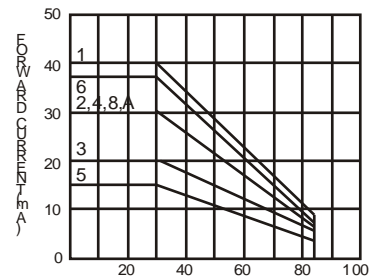

AMBIENT TEMPERATURE Ta( )  
FORWARD CURRENT VS. AMBIENT  
TEMPERATURE



AMBIENT TEMPERATURE Ta( )

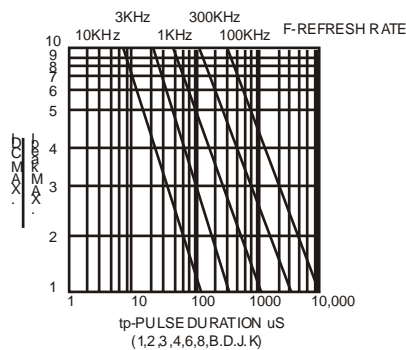

tp-PULSE DURATION µs  
(1,2,3,4,6,8,B,D,J,K)

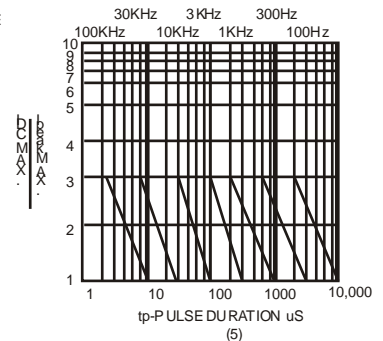

(5)

NOTE:25 free air temperature unless otherwise specified

**SUPER FLUX LED LAMP, 4PIN LED**

BL-FL7670xx

**Packing and weighting**

