



LED1450-series



TECHNICAL DATA

Infrared LED

InGaAsP

LED1450-series are InGaAsP LEDs mounted on a lead frame and encapsulated in various types of epoxy lens, which offers different design settings.

On forward bias, it emits a high power radiation of typical 2.5 mW at a peak wavelength at 1450 nm.

Specifications

- Structure: InGaAsP
- Peak Wavelength: typ. 1450 nm
- Optical Output Power: typ. 2.5 mW
- Resin Material: Epoxy resin
- Solder: Lead free



Absolute Maximum Ratings ($T_a=25^\circ\text{C}$)

Type	Symbol	Value	Unit
Power Dissipation	P_D	140	mW
Forward Current	I_F	100	mA
Pulse Forward Current	I_{FP}	1000	mA
Reverse Voltage	V_R	5	V
Operating Temperature	T_{OP}	-40 ... +85	$^\circ\text{C}$
Storage Temperature	T_{STG}	-40 ... +100	$^\circ\text{C}$
Soldering Temperature (for 5 sec.)	T_{SOL}	265	$^\circ\text{C}$

Electro-Optical Characteristics ($T_a=25^\circ\text{C}$)

Item	Symbol	Condition	Min.	Typ.	Max.	Unit
Forward Voltage	V_F	$I_F = 50 \text{ mA}$	-	1.0	1.5	V
Reverse Current	I_R	$V_R = 5 \text{ V}$	-	-	10	μA
Radiated Power	P_O	$I_F = 50 \text{ mA}$	1.3	2.5	-	mW
Peak Wavelength	λ_P	$I_F = 50 \text{ mA}$	1400	1450	1500	nm
Half Width	$\Delta\lambda$	$I_F = 50 \text{ mA}$	-	100	-	nm
Rise Time	t_r	$I_F = 50 \text{ mA}$	-	10	-	ns
Fall Time	t_f	$I_F = 50 \text{ mA}$	-	10	-	ns



Characteristics of Radiant Intensity ($T_a=25^\circ\text{C}$)

Type	Viewing Half Angle	Radiation Intensity ($I_F = 50 \text{ mA}$) [Unit: mW/sr]			Outer Dimension	Dimension Figure
		Min.	Typ.	Max.		
LED1450-01					Ø 5	1
LED1450-02					Ø 5	2
LED1450-03	±10°		18		Ø 5	3
LED1450-04					Ø 5	4
LED1450-05					Ø 5	5
LED1450-06	±7°		32		Ø 5	6
LED1450-09					Ø 5	7
					Oval	
LED1450-46					Ø 5	8
LED1450-41					Ø 4	9
LED1450-42					Ø 4	10
LED1450-31					Ø 3	11
LED1450-33	±18°		9		Ø 3	12
LED1450-34					Ø 3	13
LED1450-36	±33°		3		Ø 3	14

* Radiant Power is measured by G8370-85

* Brightness is measured by TekTronix J-16

Notes

- Do not view directly into the emitting area of the LED during operation!
- The above specifications are for reference purpose only and subjected to change without prior notice.



Outer Dimensions

<p>Figure-1 Ø 5Mold (Type 01)</p> <p>cup position 4.7 1.5max</p> <p>$\phi 5.8 \pm 0.2$ $\phi 5 \pm 0.2$</p> <p>9± 0.2 21 min.</p> <p>Cathode 1 typ.</p> <p>Anode 1.0± 0.2 2-0.5sq± 0.1</p>	<p>Figure-2 Ø 5Mold (Type 02)</p> <p>cup position 5.32 1.5max</p> <p>$\phi 5.8 \pm 0.2$ $\phi 5.2 \pm 0.2$</p> <p>8.5± 0.2 21 min.</p> <p>Cathode 1 typ.</p> <p>Anode 1.0± 0.2 2-0.5sq± 0.1</p>
<p>Figure-3 Ø 5Mold (Type 03)</p> <p>cup position 4.55 1.5max</p> <p>$\phi 5.8 \pm 0.2$ $\phi 5 \pm 0.2$</p> <p>8.25± 0.2 21 min.</p> <p>Cathode 1 typ.</p> <p>Anode 1.0± 0.2 2-0.5sq± 0.1</p>	<p>Figure-4 Ø 5Mold (Type 04)</p> <p>cup position 3.55 1.5max</p> <p>$\phi 5.8 \pm 0.2$ $\phi 5 \pm 0.2$</p> <p>7.7± 0.2 21 min.</p> <p>Cathode 1 typ.</p> <p>Anode 1.0± 0.2 2-0.5sq± 0.1</p>
<p>Figure-5 Ø 5Mold (Type 05)</p> <p>cup position 0.55 1.5max</p> <p>$\phi 5.4 \pm 0.2$ $\phi 4.8 \pm 0.2$</p> <p>20.25 21 min.</p> <p>Cathode 1 typ.</p> <p>Anode 1.0± 0.2 2-0.5sq± 0.1</p> <p>$\phi 4.45 \pm 0.2$</p>	<p>Figure-6 Ø 5Mold (Type 06)</p> <p>cup position 5.6 1.5max</p> <p>$\phi 5.5 \pm 0.2$ $\phi 4.8 \pm 0.2$</p> <p>8.7± 0.2 21 min.</p> <p>Cathode 1 typ.</p> <p>Anode 1.0± 0.2 2-0.5sq± 0.1</p>
<p>Figure-7 Ø 5Mold (Type 09)</p> <p>cup position 4.1 1.5max</p> <p>$\phi 5.5 \pm 0.2$ $\phi 4.7 \pm 0.2$</p> <p>7.7± 0.2 21 min.</p> <p>Cathode 1 typ.</p> <p>Anode 1.0± 0.2 2-0.5sq± 0.1</p>	<p>Figure-8 Ø 5Mold (Type 46)</p> <p>1.5max</p> <p>$\phi 5.8 \pm 0.2$ $\phi 4.8 \pm 0.2$</p> <p>4.4± 0.2 21 min.</p> <p>Cathode 1 typ.</p> <p>Anode 0.6 2-0.5sq± 0.1</p>
<p>Figure-9 Ø 4Mold (Type 41)</p> <p>cup position 3.05 1max</p> <p>$\phi 4.7 \pm 0.2$ $\phi 3.9 \pm 0.2$</p> <p>6.45± 0.2 21 min.</p> <p>Cathode 1 typ.</p> <p>Anode 1.5± 0.2 2-0.5sq± 0.1</p>	<p>Figure-10 Ø 4Mold (Type 42)</p> <p>cup position 3.05 1max</p> <p>$\phi 4.7 \pm 0.2$ $\phi 3.9 \pm 0.2$</p> <p>6.45± 0.2 21 min.</p> <p>Cathode 1 typ.</p> <p>Anode 1.5± 0.2 2-0.5sq± 0.1</p>

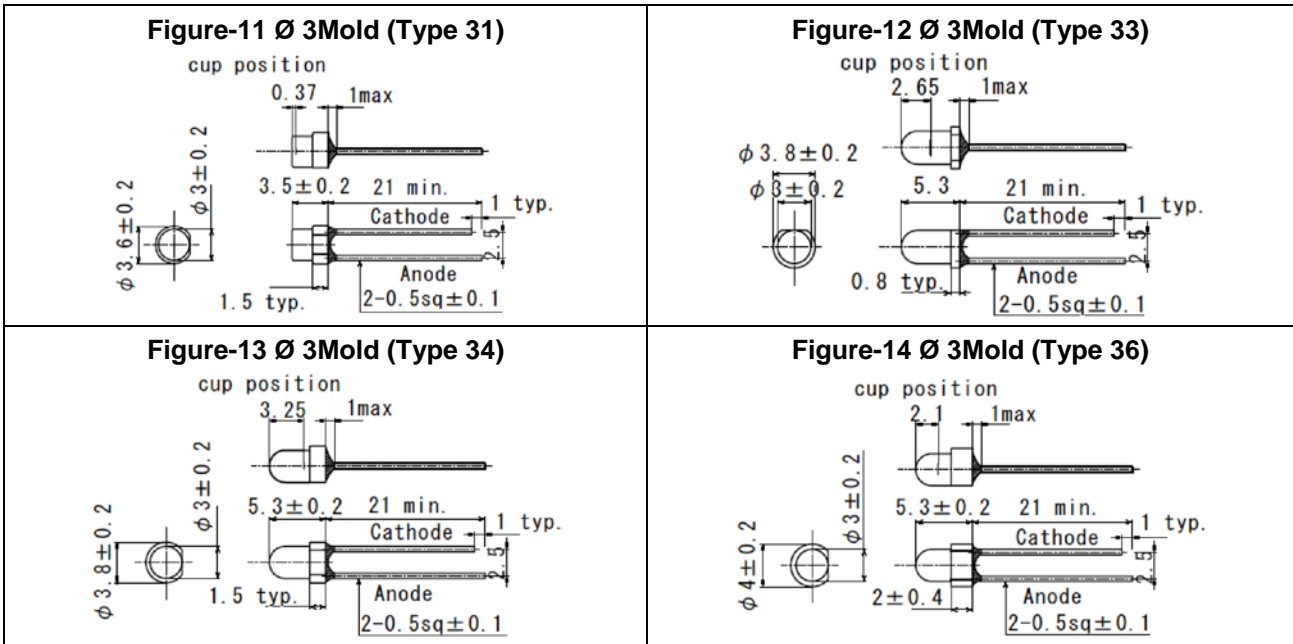

Viewing half angle

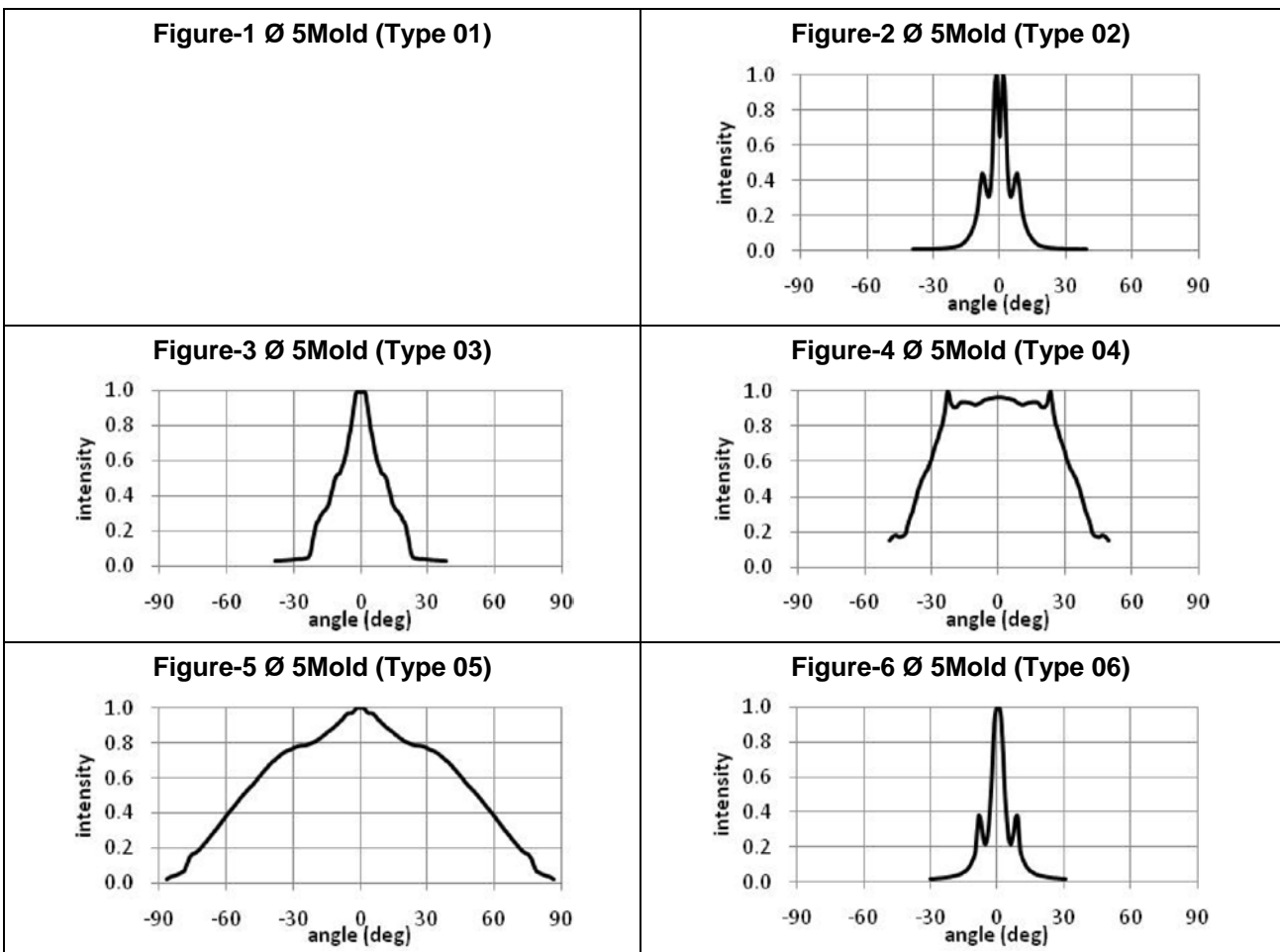
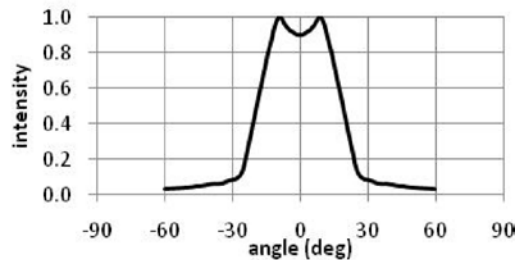
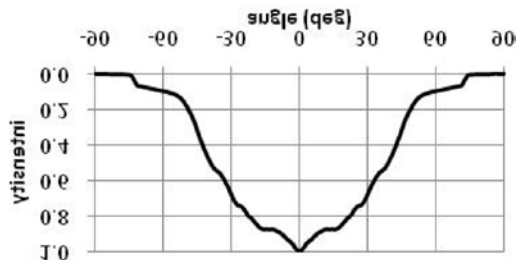
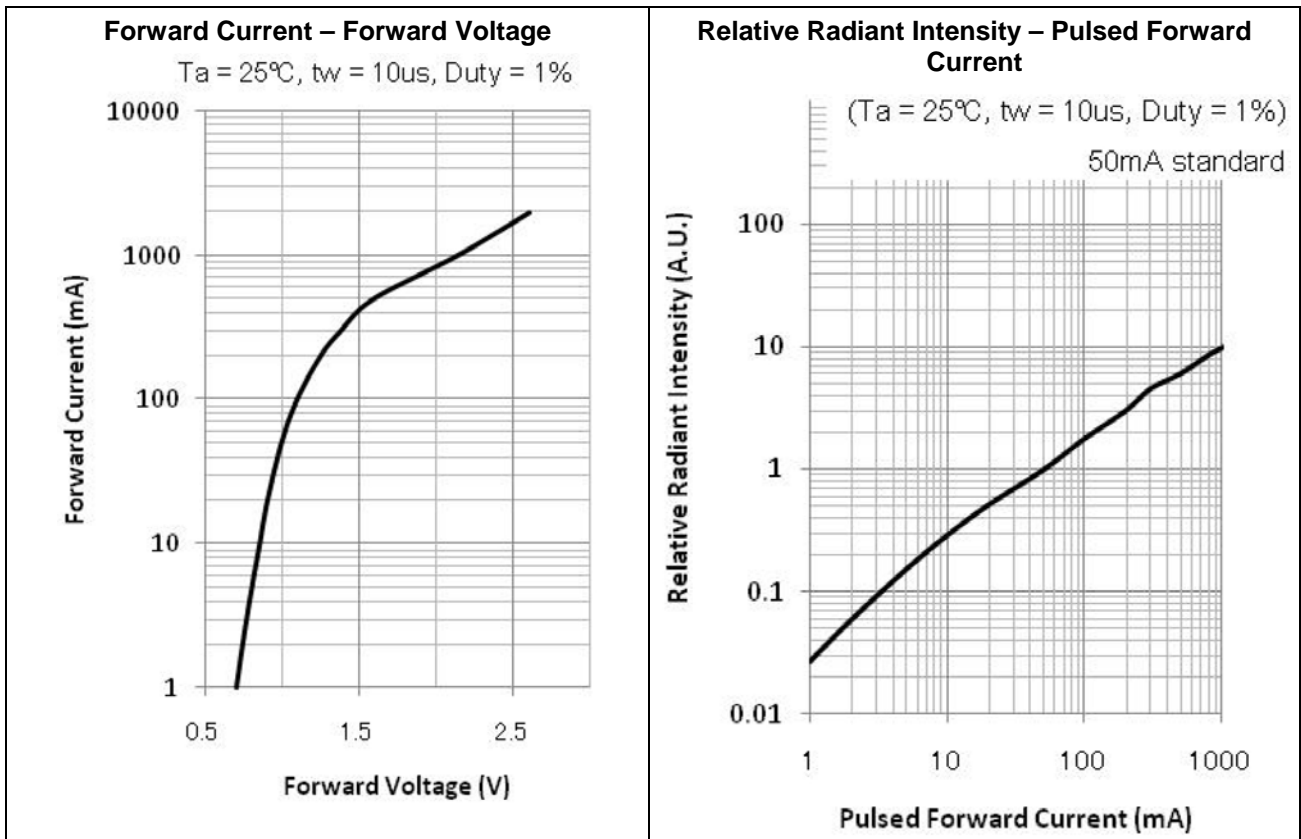
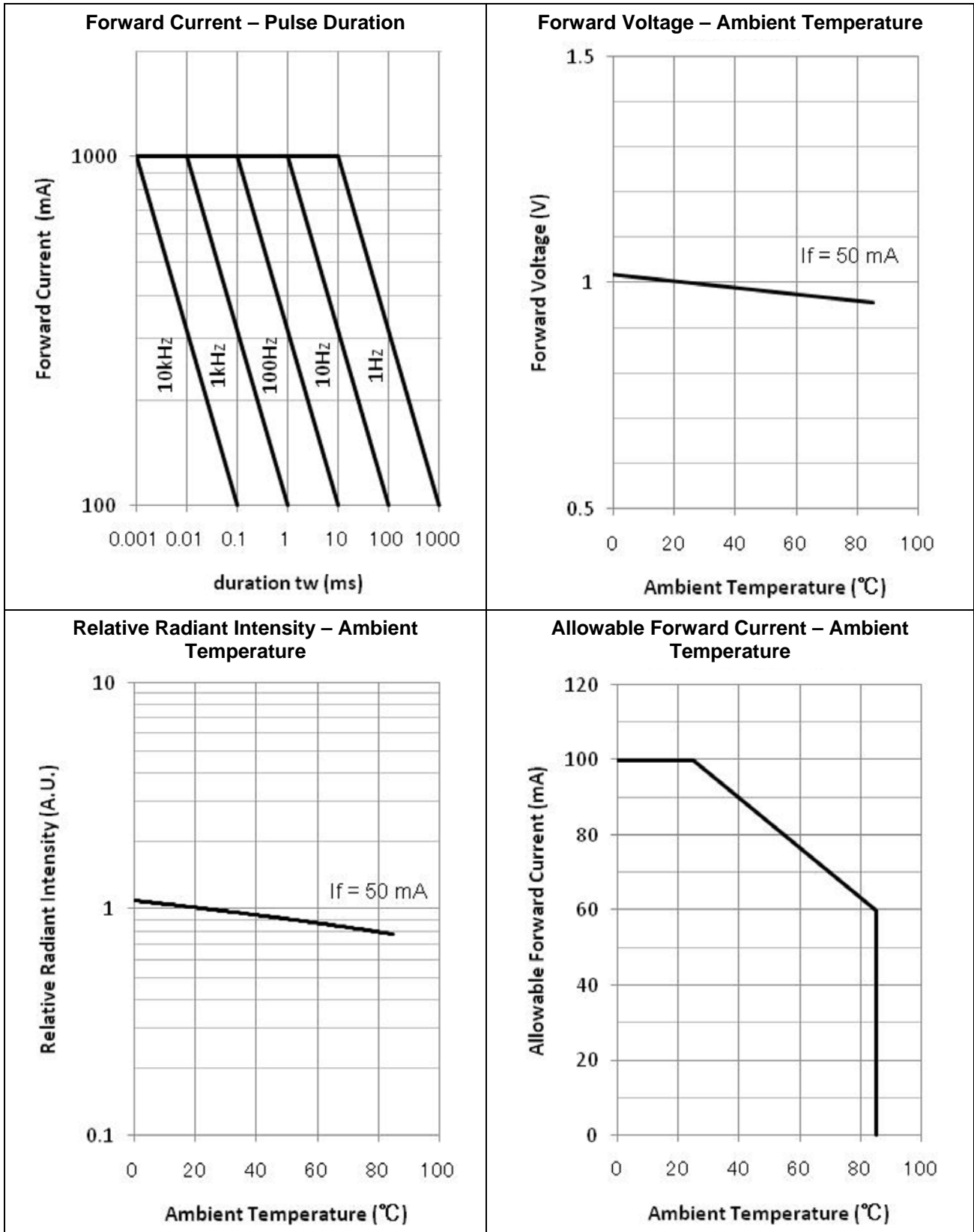

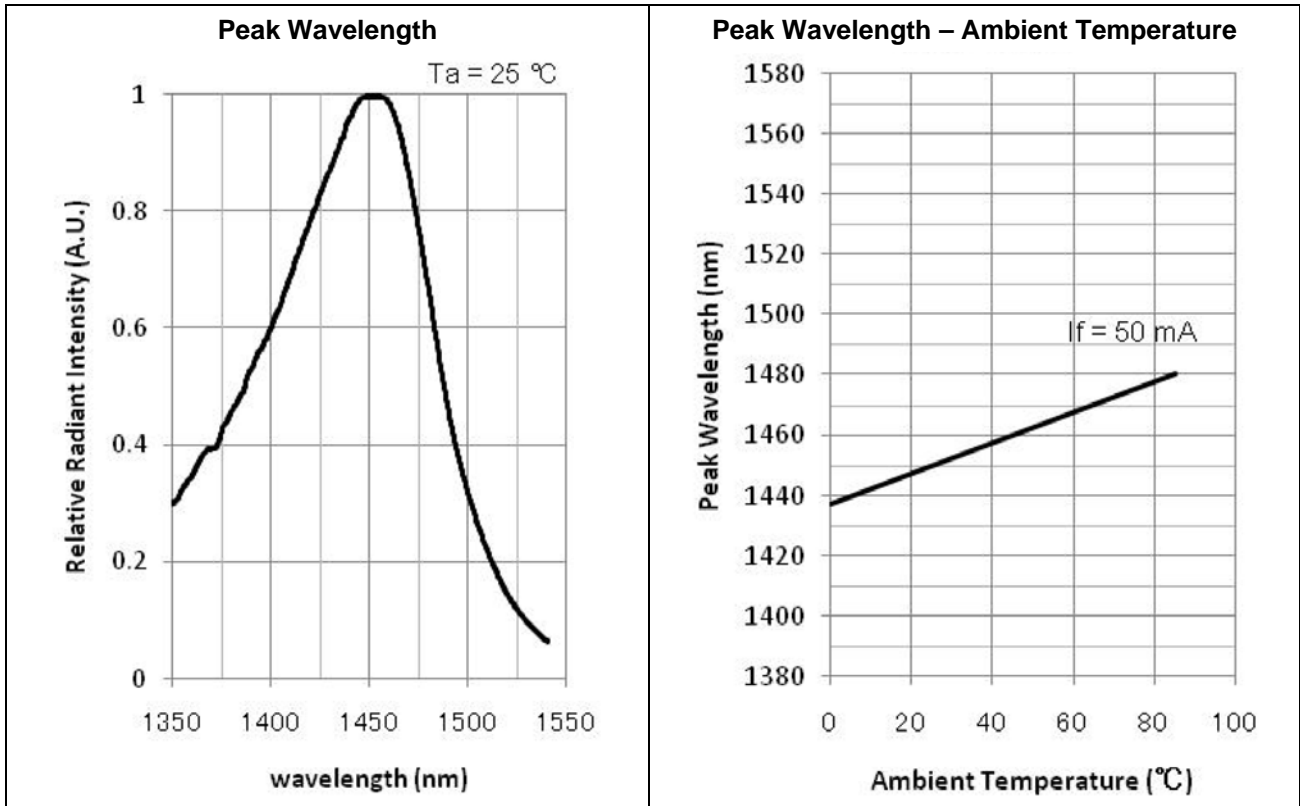

Figure-7 Ø 5Mold (Type 09)	Figure-8 Ø 5Mold (Type 46)
Figure-9 Ø 4Mold (Type 41)	Figure-10 Ø 4Mold (Type 42)
Figure-11 Ø 3Mold (Type 31)	Figure-12 Ø 3Mold (Type 33) 
Figure-13 Ø 3Mold (Type 34)	Figure-14 Ø 3Mold (Type 36) 

Typical Performance Curves







Precaution for Use

1. Cautions

- DO NOT look directly into the emitted light or look through the optical system. To prevent in adequate exposure of the radiation, wear protective glasses.
- The LEDs are emitting invisible light.

2. Lead Forming

- When forming leads, the leads should be bent at a point at least 3 mm from the base of the lead. DO NOT use the base of the leadframe as a fulcrum during lead forming.
- Lead forming should be done before soldering.
- DO NOT apply any bending stress to the base of the lead. The stress to the base may damage the LED's characteristics or it may break the LEDs.
- When mounted the LEDs onto the printed circuit board, the holes on the circuit board should be exactly aligned with the leads of LEDs. If the LEDs are mounted with stress at the leads, it causes deterioration of the lead and it will degrade the LEDs.



Recommended Land Layout (Unit: mm)

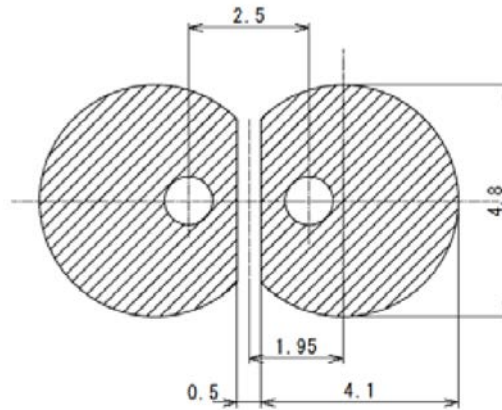

3. Soldering Conditions

- Solder the LEDs no closer than 3 mm from the base of the lead.
- DO NOT apply any stress to the lead particularly when heat.
- The LEDs must not be reposition after soldering.
- After soldering the LEDs, the lead should be protected from mechanical shock or vibration until the LEDs return to room temperature.
- When it is necessary to clamp the LEDs to prevent soldering failure, it is important to minimize the mechanical stress on the LEDs.
- Cut the LED leads at room temperature. Cutting the leads at high temperature may cause the failure of the LEDs.

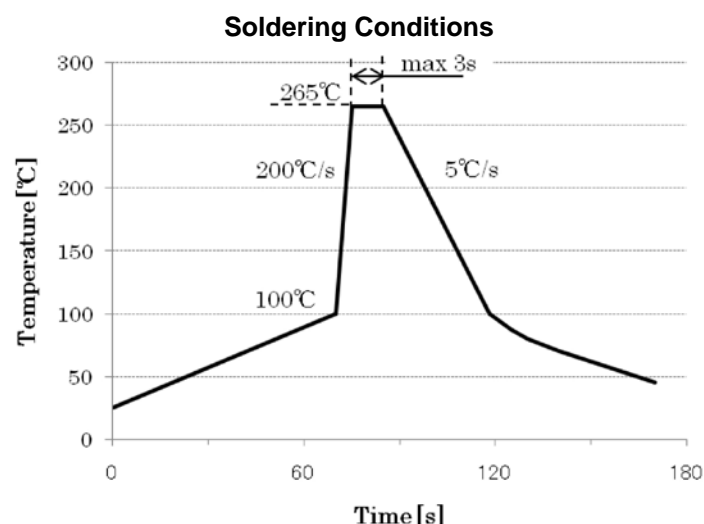

4. Static Electricity

- The LEDs are very sensitive to Static Electricity and surge voltage. So it is recommended that a wrist band or an anti-electrostatic glove be used when handling the LEDs.
- All devices, equipment and machinery must be grounded properly. It is recommended that precautions should be taken against surge voltage to the equipment that mounts the LEDs.