

## Open Carrier Double-Balanced Mixer For Microwave Telecommunications

**MC2307**  
V2

### Features

- LO 2.2 TO 8.0 GHz
- RF 3.4 TO 7.0 GHz
- IF DC TO 2.0 GHz
- LO DRIVE +7 dBm (NOMINAL)
- MICROSTRIP INTERFACE

### Description

The MC2307 is a double balanced mixer, designed for use in military, commercial and test equipment applications. The design utilizes Schottky ring quad diodes and broadband soft dielectric and ferrite baluns to attain excellent performance. This mixer can also be used as a phase detector and/or bi-phase modulator since the IF port is DC coupled to the diodes. The use of high temperature solder and welded assembly processes used internally makes it ideal for use in manual, semi-automated assembly. Environmental screening available to MIL-STD-883, MIL-STD-202, or MIL-DTL-28837, consult factory.

### Product Image



### Ordering Information

Part Number	Package
MC2307	Open Carrier
MC2307-2	Open Carrier

### Electrical Specifications: $Z_0 = 50\Omega$ $L_o = +7$ dBm (Downconverter application only)

Parameter	Test Conditions	Units	Typical	Guaranteed	
				+25°C	-54° to +85°C
SSB Conversion Loss (max) & SSB Noise Figure (max)	fR=3.4 to 7 GHz, fL=2.2 to 8 GHz, fl=0.05 to 0.5 GHz	dB	5.2	7.0	7.5
	fR=3.4 to 7 GHz, fL=2.2 to 8 GHz, fl=0.05 to 1.5 GHz	dB	6.5	8.0	8.5
	fR=3.4 to 7 GHz, fL=2.2 to 8 GHz, fl=0.05 to 2 GHz	dB	7.0	8.5	9.0
Isolation, L to R (min)	fL = 2.2 to 3 GHz	dB	25	18	16
	fL = 3 to 8 GHz	dB	40	28	26
Isolation, L to I (min)	fL = 2.2 to 3 GHz	dB	20	13	11
	fL = 3 to 4 GHz	dB	30	18	16
	fL = 4 to 8 GHz	dB	42	30	28
Isolation, R to I (min)	fL = 3.4 to 7 GHz	dB	26		
1 dB Conversion Comp.	fL = +7 dBm	dBm	+1		
Input IP3	fR1 = 4.2 GHz at -10 dBm, fR2 = 4.21 at -10 dBm, fL = 2.7 GHz at +7 dBm	dBm	+10		
	fR1 = 6 GHz at -10 dBm, fR2 = 6.01 at -10 dBm, fL = 4.5 GHz at +7 dBm	dBm	+11		

1

M/A-COM Inc. and its affiliates reserve the right to make changes to the product(s) or information contained herein without notice. M/A-COM makes no warranty, representation or guarantee regarding the suitability of its products for any particular purpose, nor does M/A-COM assume any liability whatsoever arising out of the use or application of any product(s) or information.

• **North America** Tel: 800.366.2266 / Fax: 978.366.2266  
 • **Europe** Tel: 44.1908.574.200 / Fax: 44.1908.574.300  
 • **Asia/Pacific** Tel: 81.44.844.8296 / Fax: 81.44.844.8298

Visit [www.macom.com](http://www.macom.com) for additional data sheets and product information.

**Open Carrier Double-Balanced Mixer  
For Microwave Telecommunications**

**MC2307**  
V2

**Typical Performance Curves**

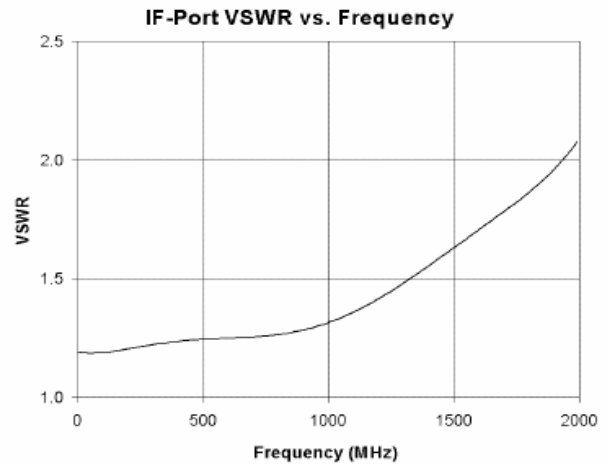
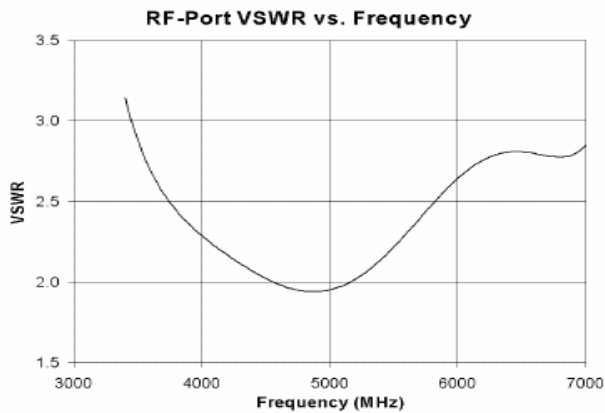
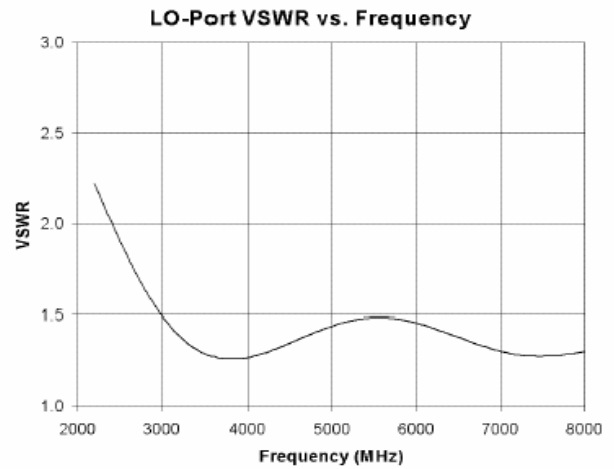
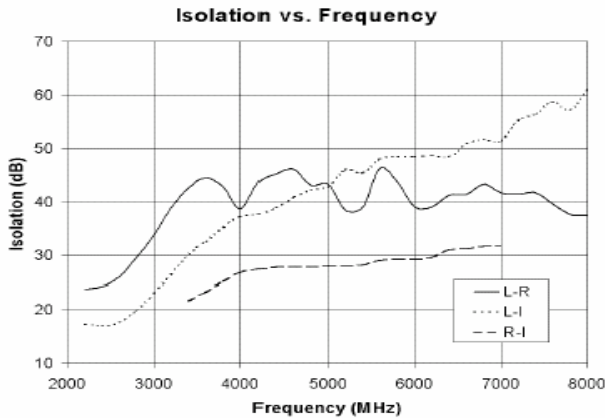
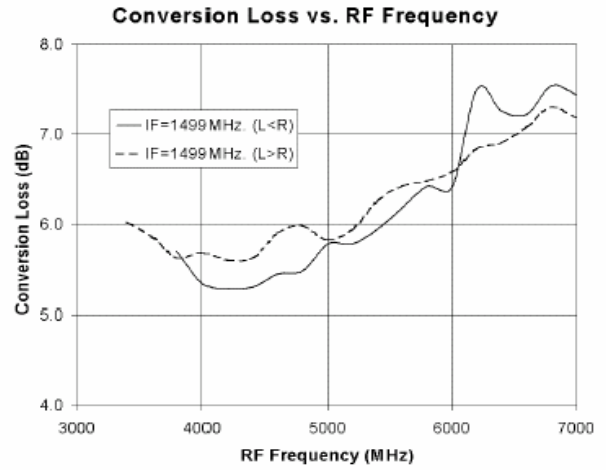
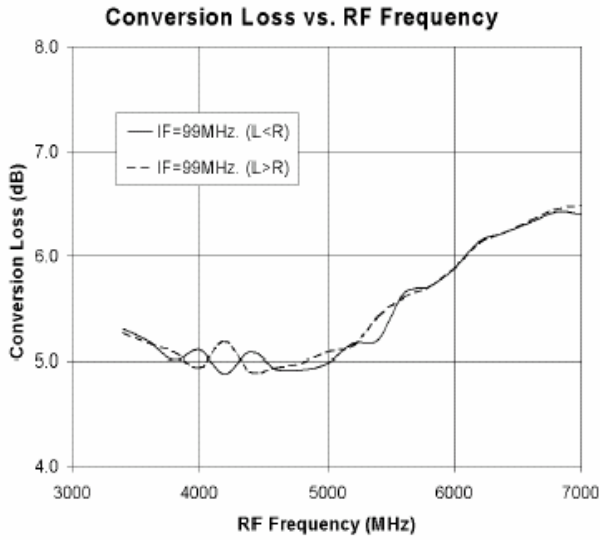

**Open Carrier Double-Balanced Mixer  
For Microwave Telecommunications**

**MC2307**  
V2

**Absolute Maximum Ratings**

Parameter	Absolute Maximum
Operating Temperature	-54°C to +85°C
Storage Temperature	-65°C to +100°C
Peak Input Power	+23 dBm max @ +25°C +20 dBm max @ +85°C
Peak Input Current	50 mA DC

**Outline Drawing: Open Carrier \*MC2307**

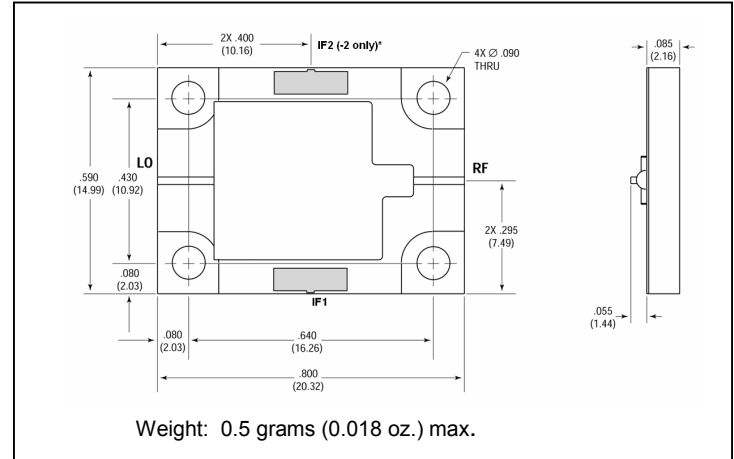

\*For the base model, only the IF1 port is connected.  
For the “-2” model only the IF2 port is connected.

\* Dimensions are inches (millimeters) ±0.015 (0.38) unless otherwise specified.