

Digital Transistors (Built-in Resistors)

DTA114TM/DTA114TE/DTA114TUA DTA114TKA /DTA114TCA/DTA114TSA

DIGITAL TRANSISTOR (PNP)



FEATURES

- Built-in bias resistors enable the configuration of an inverter circuit without connecting external input resistors(see equivalent circuit)
- The bias resistors consist of thin-film resistors with complete isolation to allow positive biasing of the input.They also have the advantage of almost completely eliminating parasitic effects
- Only the on/off conditions need to be set for operation, making device design easy

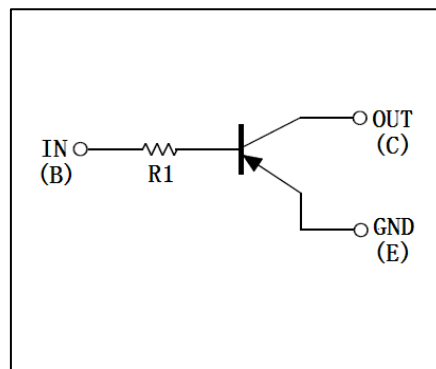
• Equivalent Circuit

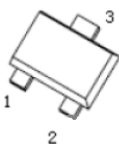
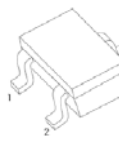
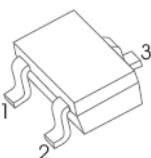
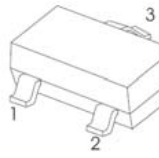
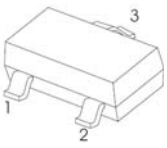

PIN CONNENCTIONS and MARKING

<p>DTA114TM</p>  <p>SOT-723</p> <p>1. IN 2. GND 3. OUT</p> <p>MARKING:94</p>	<p>DTA114TE</p>  <p>SOT-523</p> <p>1. IN 2. GND 3. OUT</p> <p>MARKING:94</p>
<p>DTA114TUA</p>  <p>SOT-323</p> <p>1. IN 2. GND 3. OUT</p> <p>MARKING:94</p>	<p>DTA114TKA</p>  <p>SOT-23-3L</p> <p>1. IN 2. GND 3. OUT</p> <p>MARKING:94</p>
<p>DTA114TCA</p>  <p>SOT-23</p> <p>1. IN 2. GND 3. OUT</p> <p>MARKING:94</p>	<p>DTA114TSA</p>  <p>TO-92S</p> <p>1. GND 2. OUT 3. IN</p>

MAXIMUM RATINGS(Ta=25°C unless otherwise noted)

Symbol	Parameter	Limits(DTA114T□)						Unit
		M	E	UA	KA	CA	SA	
V _{CBO}	Collector-Base Voltage	-50						V
V _{CEO}	Collector-Emitter Voltage	-50						V
V _{EBO}	Emitter-Base Voltage	-5						V
I _C	Collector Current	-100						mA
P _D	Power Dissipation	100	150	200	200	200	300	mW
T _J	Junction Temperature	150						°C
T _{stg}	Storage Temperature	-55~+150						°C

ELECTRICAL CHARACTERISTICS (Ta=25°C unless otherwise specified)

Parameter	Symbol	Conditions	Min	Typ	Max	Unit
Collector-base breakdown voltage	V _{(BR)CBO}	I _C =-50μA, I _E =0	-50			V
Collector-emitter breakdown voltage	V _{(BR)CEO}	I _C =-1mA, I _B =0	-50			V
Emitter-base breakdown voltage	V _{(BR)EBO}	I _E =-50μA, I _C =0	-5			V
Collector cut-off current	I _{CBO}	V _{CB} =-50V, I _E =0			-0.5	μA
Emitter cut-off current	I _{EBO}	V _{EB} =-4V, I _C =0			-0.5	μA
DC current gain	h _{FE}	V _{CE} =-5V, I _C =-1mA	100	250	600	
Collector-emitter saturation voltage	V _{CE(sat)}	I _C =-10mA, I _B =-1mA			-0.3	V
Transition frequency	f _T	V _{CE} =-10V, I _E =5mA, f=100MHz		250		MHz
Input resistor	R ₁		7	10	13	kΩ

Static Characteristic

