

## Single Phase Bridge (Power Modules), 25 A/35 A



GBPC...A



GBPC...W

### FEATURES

- Universal, 3 way terminals: push-on, wrap around or solder
- High thermal conductivity package, electrically insulated case
- Positive polarity symbol molded on the plastic case
- Center hole fixing
- Glass passivated diode chips
- Excellent power/volume ratio
- Nickel plated terminals solderable using lead (Pb)-free solder; Solder Alloy Sn/Ag/Cu (SAC305); Solder temperature 260 °C to 275 °C
- Wire lead version available
- UL E300359 approved
- Designed and qualified for industrial and consumer level
- Material categorization: For definitions of compliance please see [www.vishay.com/doc?99912](http://www.vishay.com/doc?99912)



RoHS  
COMPLIANT

PRODUCT SUMMARY	
$I_o$	25 A to 35 A
$V_{RRM}$	200 V to 1200 V
Package	GBPC..A, GBPC..W
Circuit	Single phase bridge

### DESCRIPTION/APPLICATIONS

A range of extremely compact, encapsulated single phase bridge rectifiers offering efficient and reliable operation. They are intended for use in general purpose and instrumentation applications.

MAJOR RATINGS AND CHARACTERISTICS				
SYMBOL	CHARACTERISTICS	VALUES GBPC25	VALUES GBPC35	UNITS
$I_o$		25	35	A
	$T_C$	60	55	°C
$I_{FSM}$	50 Hz	400	475	A
	60 Hz	420	500	
$I^2t$	50 Hz	790	1130	A <sup>2</sup> s
	60 Hz	725	1030	
$V_{RRM}$	Range	200 to 1200		V
$T_J$		-55 to 150		°C

### ELECTRICAL SPECIFICATIONS

VOLTAGE RATINGS					
TYPE NUMBER	VOLTAGE CODE	$V_{RRM}$ , MAXIMUM REPETITIVE PEAK AC REVERSE VOLTAGE $T_J = T_J$ MAXIMUM V	$V_{RSM}$ , MAXIMUM NON-REPETITIVE PEAK AC REVERSE VOLTAGE $T_J = T_J$ MAXIMUM V	$I_{RRM}$ MAXIMUM AT RATED $V_{RRM}$ $T_J = T_J$ MAXIMUM mA	$I_{RRM}$ MAXIMUM DC REVERSE CURRENT AT $T_J = 125$ °C A
VS-GBPC25/35..A <sup>(1)</sup> VS-GBPC25/35..W	02	200	275	2	500
	04	400	500		
	06	600	725		
	08	800	900		
	10	1000	1100		
	12	1200	1300		

**Note**

<sup>(1)</sup> See Ordering Information table at the end of datasheet

FORWARD CONDUCTION							
PARAMETER	SYMBOL	TEST CONDITIONS		VALUES GBPC25	VALUES GBPC35	UNITS	
Maximum DC output current at case temperature	$I_O$	Resistive or inductive load		25	35	A	
		Capacitive load		20	28		
				60	55	°C	
Maximum peak, one-cycle non-repetitive forward current	$I_{FSM}$	$t = 10$ ms	No voltage reapplied	Initial $T_J = T_J$ maximum	400	475	A
		$t = 8.3$ ms					
		$t = 10$ ms	100 % $V_{RRM}$ reapplied		335	400	
		$t = 8.3$ ms					
Maximum $I^2t$ for fusing	$I^2t$	$t = 10$ ms	No voltage reapplied	Initial $T_J = T_J$ maximum	790	1130	A <sup>2</sup> s
		$t = 8.3$ ms					
		$t = 10$ ms	100 % $V_{RRM}$ reapplied		560	800	
		$t = 8.3$ ms					
Maximum $I^2\sqrt{t}$ for fusing	$I^2\sqrt{t}$	$I^2t$ for time $t_x = I^2\sqrt{t} \times \sqrt{t_x}$ ; $0.1 \leq t_x \leq 10$ ms, $V_{RRM} = 0$ V		7.9	11.3	kA <sup>2</sup> √s	
Low level of threshold voltage	$V_{F(TO)1}$	$(16.7\% \times \pi \times I_{F(AV)} < I < \pi \times I_{F(AV)})$ , $T_J$ maximum		0.76	0.77	V	
High level of threshold voltage	$V_{F(TO)2}$	$(I > \pi \times I_{F(AV)})$ , $T_J$ maximum		0.89	0.92		
Low level forward slope resistance	$r_{t1}$	$(16.7\% \times \pi \times I_{F(AV)} < I < \pi \times I_{F(AV)})$ , $T_J$ maximum		8.2	4.852	mΩ	
High level forward slope resistance	$r_{t2}$	$(I > \pi \times I_{F(AV)})$ , $T_J$ maximum		6.8	3.867		
Maximum forward voltage drop	$V_{FM}$	$T_J = 25$ °C, $I_{FM} = I_{Favg}$ (arm)		1.1	1.1	V	
Maximum DC reverse current	$I_{RRM}$	$T_J = 25$ °C, per diode at $V_{RRM}$		5.0		μA	
RMS isolation voltage base plate	$V_{INS}$	$f = 50$ Hz, $t = 1$ s		2700		V	

THERMAL AND MECHANICAL SPECIFICATIONS						
PARAMETER	SYMBOL	TEST CONDITIONS		VALUES GBPC25	VALUES GBPC35	UNITS
Junction and storage temperature range	$T_J, T_{Stg}$			-55 to 150		°C
Maximum thermal resistance, junction to case per bridge	$R_{thJC}$	DC operation		1.7	1.4	K/W
Maximum thermal resistance, case to heatsink	$R_{thCS}$	Mounting surface, smooth, flat and greased		0.2		
Approximate weight				16		g
Mounting torque ± 10 %		Bridge to heatsink		2.0		N · m (lbf · in)

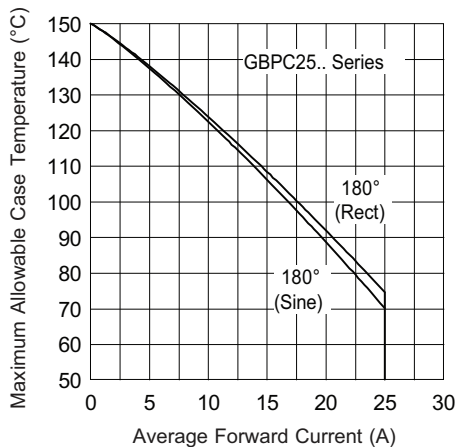

Fig. 1 - Current Ratings Characteristics

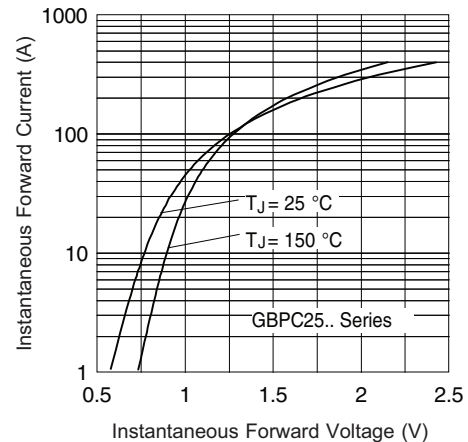

Fig. 2 - Forward Voltage Drop Characteristics

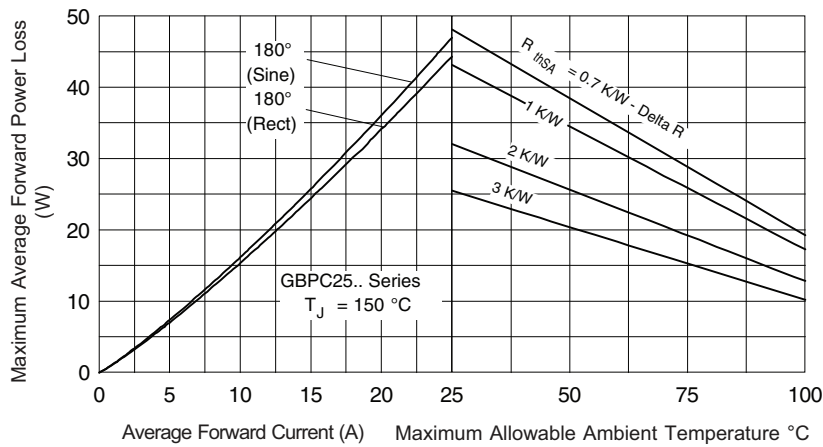

Fig. 3 - Total Power Loss Characteristics

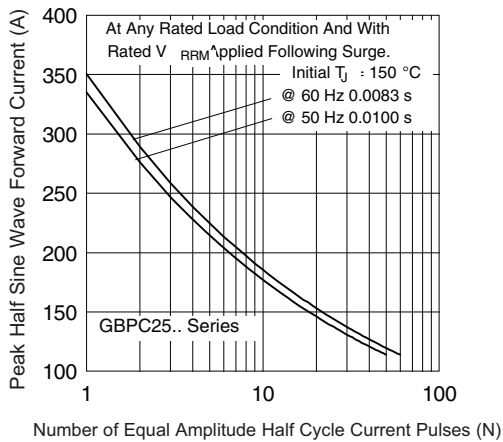

Fig. 4 - Maximum Non-Repetitive Surge Current

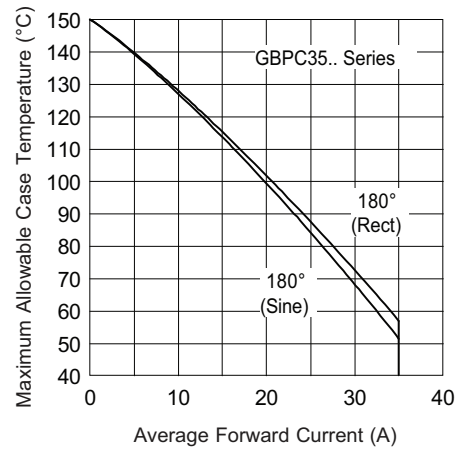

Fig. 6 - Current Ratings Characteristics

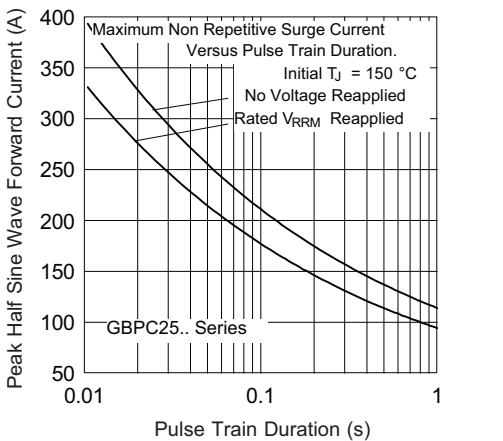

Fig. 5 - Maximum Non-Repetitive Surge Current

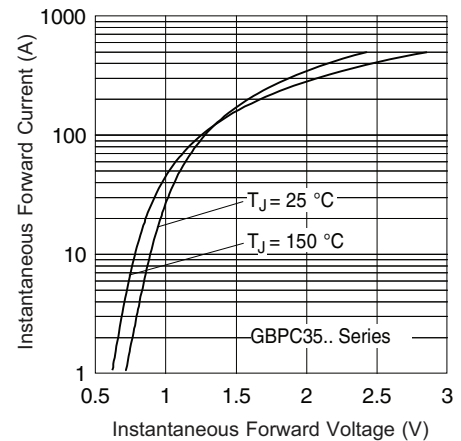

Fig. 7 - Forward Voltage Drop Characteristics

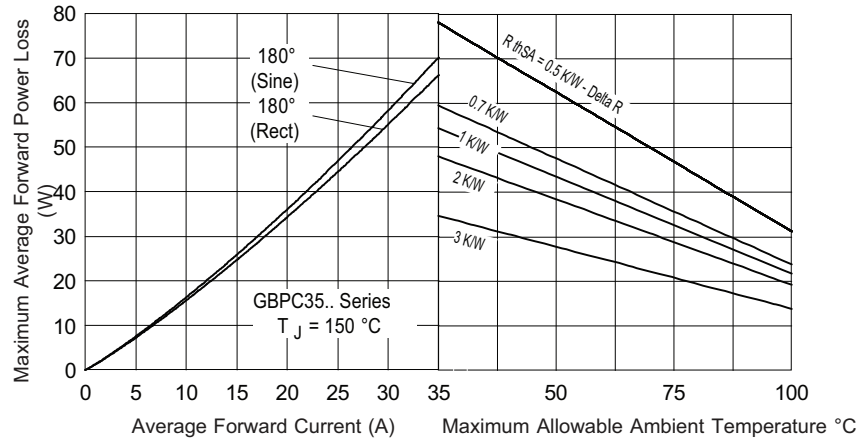

Fig. 8 - Total Power Loss Characteristics

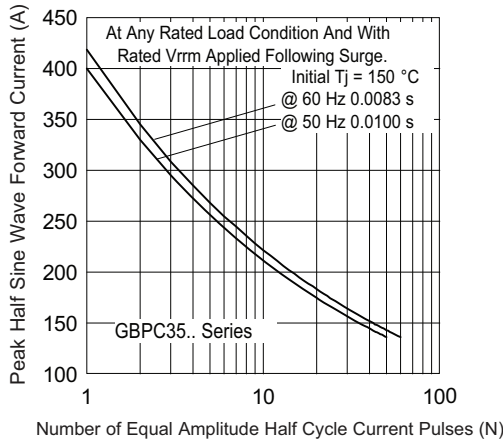

Fig. 9 - Maximum Non-Repetitive Surge Current

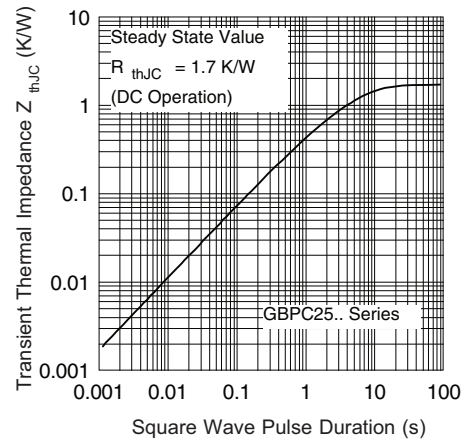

Fig. 11 - Thermal Impedance  $Z_{thJC}$  Characteristic

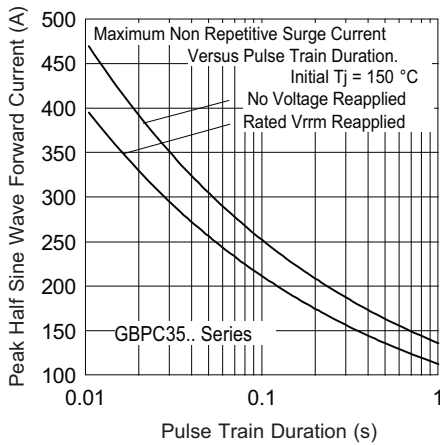

Fig. 10 - Maximum Non-Repetitive Surge Current

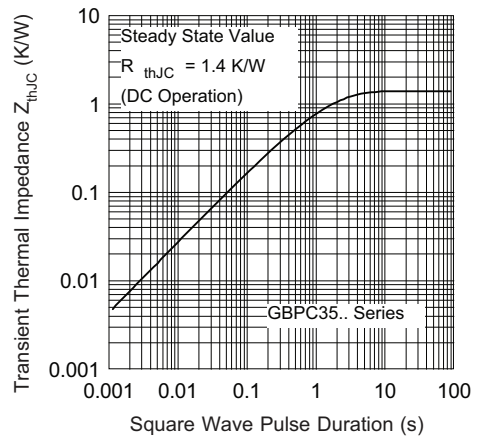
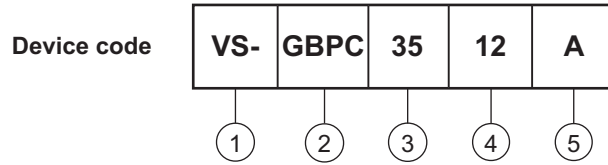

Fig. 12 - Thermal Impedance  $Z_{thJC}$  Characteristic

## ORDERING INFORMATION TABLE



- 1** - Vishay Semiconductors product
- 2** - Circuit configuration:  
Single phase bridge coding
- 3** - Current rating code
 

25 = 25 A (average)
35 = 35 A (average)
- 4** - Voltage code x 100 =  $V_{RRM}$
- 5** - Diode bridge rectifier:
  - A = Standard fast-on terminal
  - W = Wire lead

## CIRCUIT CONFIGURATION

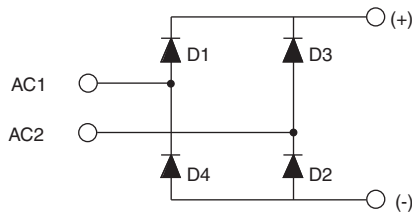

LINKS TO RELATED DOCUMENTS	
Dimensions	<a href="http://www.vishay.com/doc?95331">www.vishay.com/doc?95331</a>

## GBPC

### DIMENSIONS FOR GBPC...A in millimeters

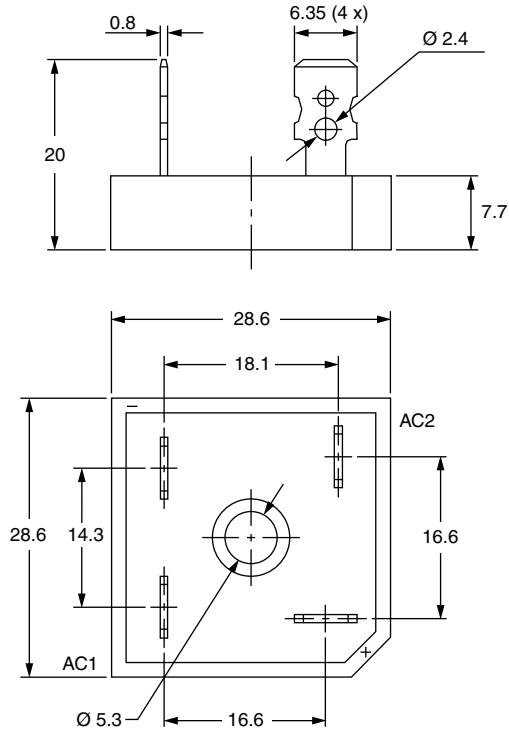

### DIMENSIONS FOR GBPC...W in millimeters

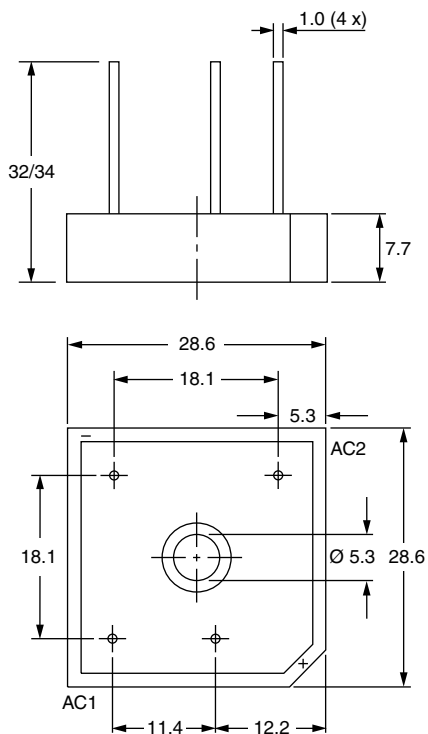



## Disclaimer

ALL PRODUCT, PRODUCT SPECIFICATIONS AND DATA ARE SUBJECT TO CHANGE WITHOUT NOTICE TO IMPROVE RELIABILITY, FUNCTION OR DESIGN OR OTHERWISE.

Vishay Intertechnology, Inc., its affiliates, agents, and employees, and all persons acting on its or their behalf (collectively, "Vishay"), disclaim any and all liability for any errors, inaccuracies or incompleteness contained in any datasheet or in any other disclosure relating to any product.

Vishay makes no warranty, representation or guarantee regarding the suitability of the products for any particular purpose or the continuing production of any product. To the maximum extent permitted by applicable law, Vishay disclaims (i) any and all liability arising out of the application or use of any product, (ii) any and all liability, including without limitation special, consequential or incidental damages, and (iii) any and all implied warranties, including warranties of fitness for particular purpose, non-infringement and merchantability.

Statements regarding the suitability of products for certain types of applications are based on Vishay's knowledge of typical requirements that are often placed on Vishay products in generic applications. Such statements are not binding statements about the suitability of products for a particular application. It is the customer's responsibility to validate that a particular product with the properties described in the product specification is suitable for use in a particular application. Parameters provided in datasheets and/or specifications may vary in different applications and performance may vary over time. All operating parameters, including typical parameters, must be validated for each customer application by the customer's technical experts. Product specifications do not expand or otherwise modify Vishay's terms and conditions of purchase, including but not limited to the warranty expressed therein.

Except as expressly indicated in writing, Vishay products are not designed for use in medical, life-saving, or life-sustaining applications or for any other application in which the failure of the Vishay product could result in personal injury or death. Customers using or selling Vishay products not expressly indicated for use in such applications do so at their own risk. Please contact authorized Vishay personnel to obtain written terms and conditions regarding products designed for such applications.

No license, express or implied, by estoppel or otherwise, to any intellectual property rights is granted by this document or by any conduct of Vishay. Product names and markings noted herein may be trademarks of their respective owners.

## Material Category Policy

**Vishay Intertechnology, Inc. hereby certifies that all its products that are identified as RoHS-Compliant fulfill the definitions and restrictions defined under Directive 2011/65/EU of The European Parliament and of the Council of June 8, 2011 on the restriction of the use of certain hazardous substances in electrical and electronic equipment (EEE) - recast, unless otherwise specified as non-compliant.**

**Please note that some Vishay documentation may still make reference to RoHS Directive 2002/95/EC. We confirm that all the products identified as being compliant to Directive 2002/95/EC conform to Directive 2011/65/EU.**

**Vishay Intertechnology, Inc. hereby certifies that all its products that are identified as Halogen-Free follow Halogen-Free requirements as per JEDEC JS709A standards. Please note that some Vishay documentation may still make reference to the IEC 61249-2-21 definition. We confirm that all the products identified as being compliant to IEC 61249-2-21 conform to JEDEC JS709A standards.**