

Applications

- Commercial and military radar
- Communications

Product Features

- Frequency Range: 16 – 18GHz
- P_{SAT}: 19dBm
- P1dB: 18dBm
- Small Signal Gain: 20dB
- Input Return Loss: 20dB
- Output Return Loss: 25dB
- Bias: V_D = 6V, I_{DQ} = 30mA, V_G = -0.6V Typical
- Chip Dimensions: 1.14 x 1.24 x 0.10 mm

Functional Block Diagram

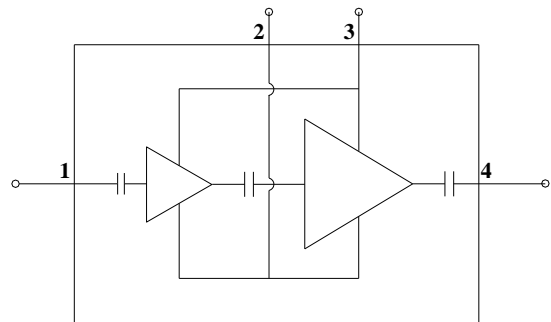

General Description

TriQuint's TGA2620 is a Ku-band MMIC driver amplifier fabricated on TriQuint's 0.15um GaAs pHEMT production process. Operating from 16-18GHz, the TGA2620 provides more than 19dBm saturated output power, 18dBm P1dB and more than 20dB small signal gain.

Fully matched to 50 ohms with integrated DC blocking capacitors on both I/O ports allows for simple system integration. The TGA2620 is an ideal choice for general purpose amplification across both commercial and military Ku-band platforms.

Lead-free and RoHS compliant.

Evaluation boards are available upon request.

Pad Configuration

Pad No.	Symbol
1	RF In
2	V _G
3	V _D
4	RF Out

Ordering Information

Part	ECCN	Description
TGA2620	EAR99	16 – 18GHz Driver Amplifier

Absolute Maximum Ratings

Parameter	Value
Drain Voltage (V_D)	6.5V
Gate Voltage Range (V_G)	-2 to 0V
Drain Current (I_D)	65mA
Gate Current (I_G)	-0.5 to 5mA
Power Dissipation (P_{DISS}), 85°C	0.3W
Input Power (P_{IN}), CW, 50Ω, $V_D=6V$, $I_{DQ}=30mA$.	15dBm
Channel Temperature (T_{CH})	150°C
Mounting Temperature (30 Seconds)	320°C
Storage Temperature	-55 to 150°C

Operation of this device outside the parameter ranges given above may cause permanent damage. These are stress ratings only, and functional operation of the device at these conditions is not implied.

Recommended Operating Conditions

Parameter	Value
Drain Voltage (V_D)	6V
Drain Current (I_{DQ})	30mA
Gate Voltage (V_G)	-0.6V (Typ.)

Electrical specifications are measured at specified test conditions. Specifications are not guaranteed over all recommended operating conditions.

Electrical Specifications

Test conditions unless otherwise noted: 25°C, $V_D = 6V$, $I_{DQ} = 30mA$, $V_G = -0.6V$ Typical, CW

Parameter	Min	Typical	Max	Units
Operational Frequency Range	16		18	GHz
Small Signal Gain		20		dB
Input Return Loss		20		dB
Output Return Loss		25		dB
Output Power (P_{SAT})		19		dBm
Power Added Efficiency (P_{SAT})		26		%
Small Signal Gain Temperature Coefficient		-0.02		dB/°C

Thermal and Reliability Information

Parameter	Test Conditions	Value	Units
Thermal Resistance (θ_{JC}) ⁽¹⁾	$T_{base} = 85^{\circ}C$	204	$^{\circ}C/W$
Channel Temperature (T_{CH}) (Under RF drive)	$V_D = 6V, I_{DQ} = 30mA, I_{D_Drive} = 55mA, CW$	138	$^{\circ}C$
Median Lifetime (T_M)	$P_{IN} = 5dBm, P_{OUT} = 18.5dBm, P_{DISS} = 260mW$	4.1×10^6	Hrs

Notes:

1. Thermal resistance measured to back of carrier plate. MMIC mounted on 20 mils CuMo carrier using 0.8mil Diemat 6030 or AuSn.

Median Lifetime

Test Conditions: $V_D = 6.5V$; Failure Criteria = 10% reduction in I_{D_MAX}

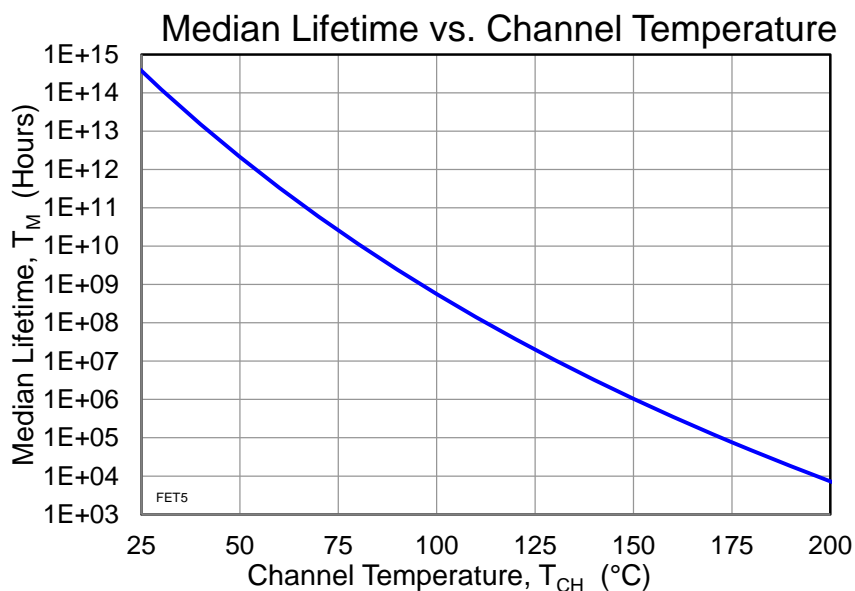

Typical Performance (Small Signal)

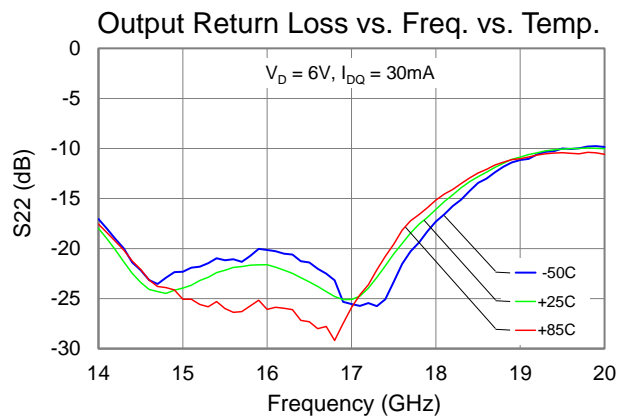
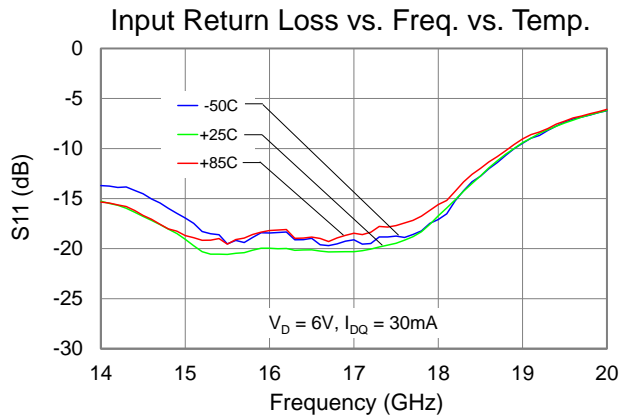
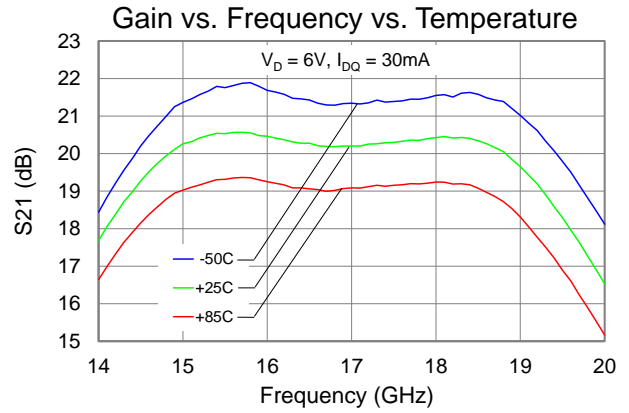
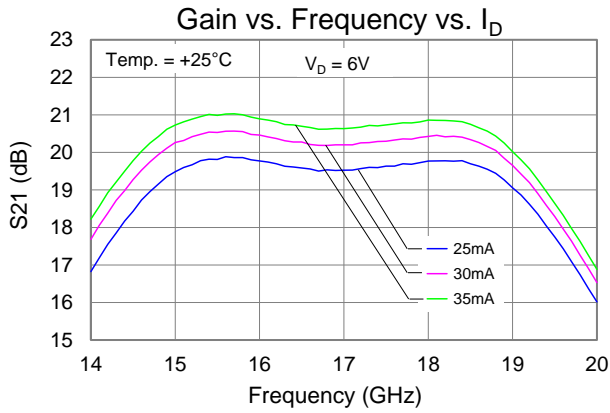

Typical Performance (Large Signal)

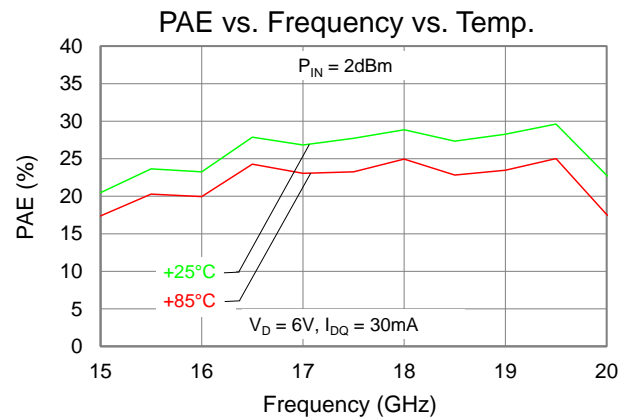
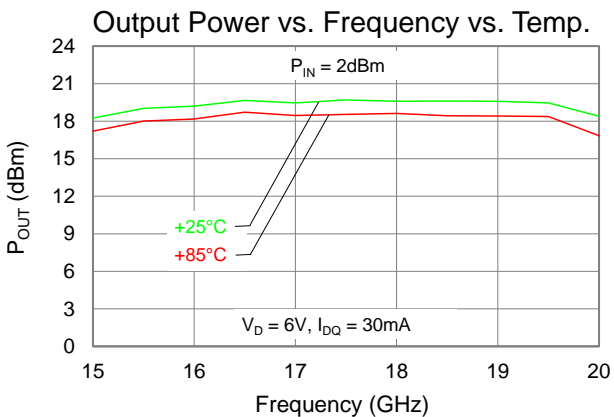
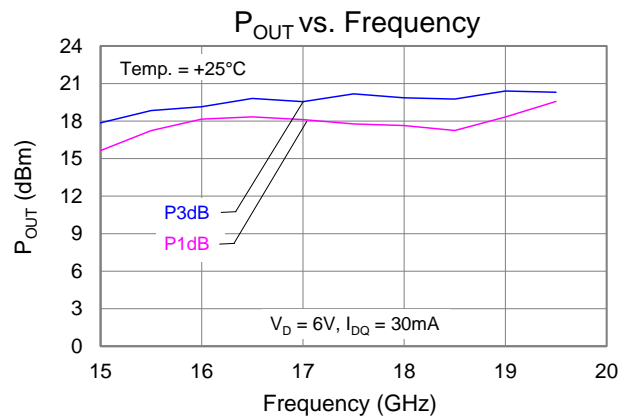
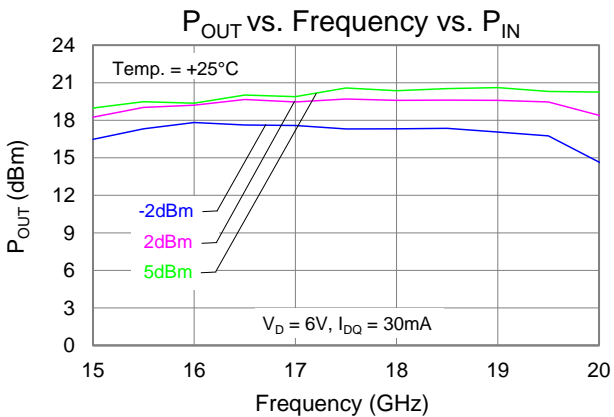
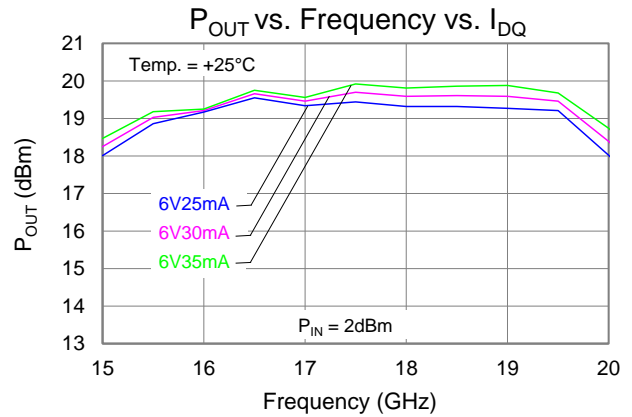
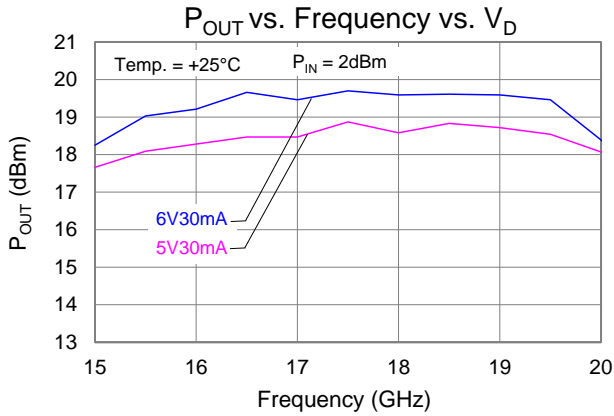

Typical Performance (Large Signal)

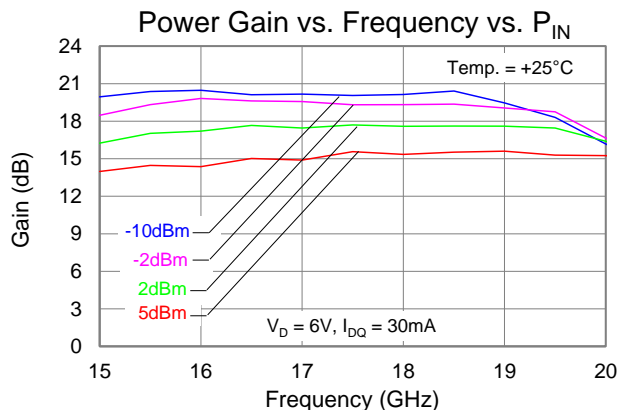
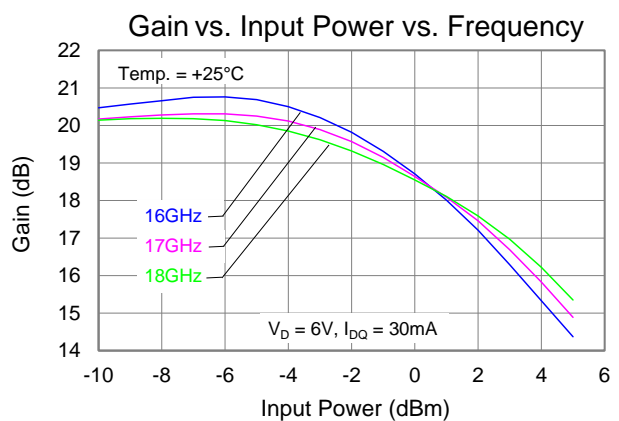
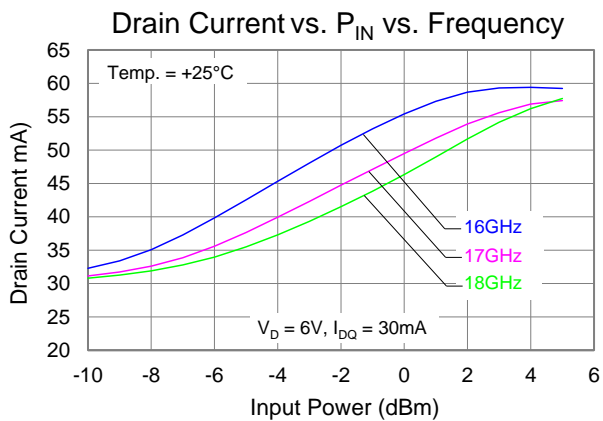
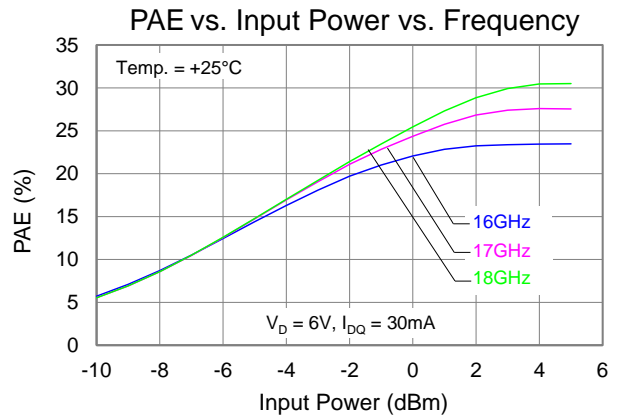
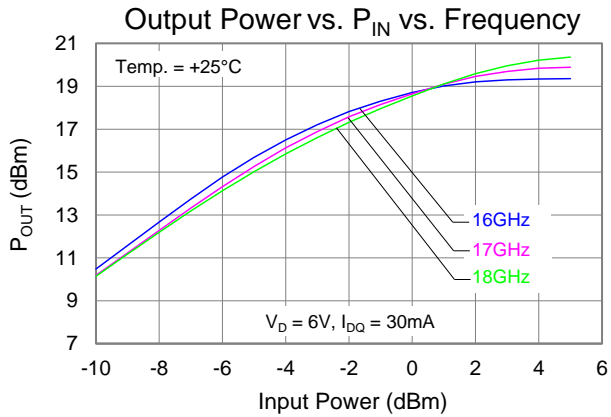

Typical Performance (Linearity)

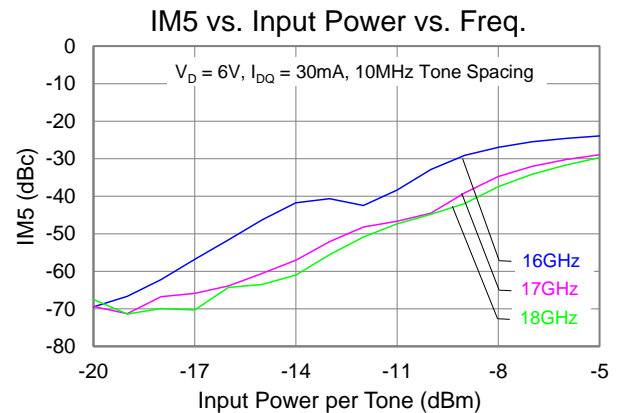
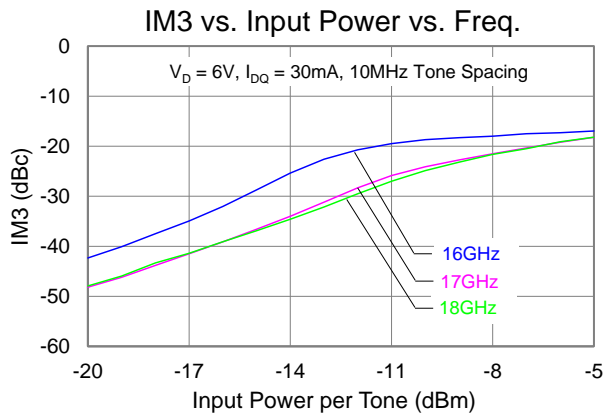
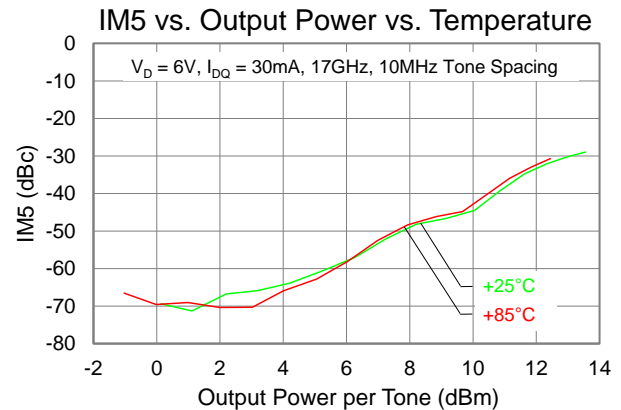
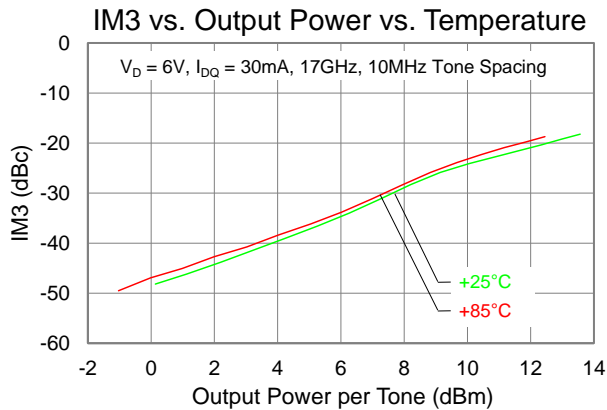
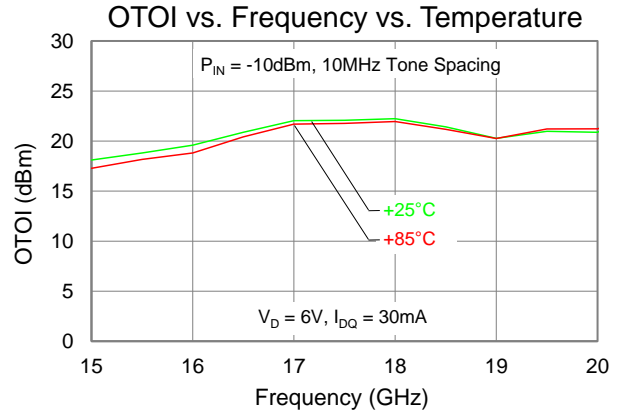
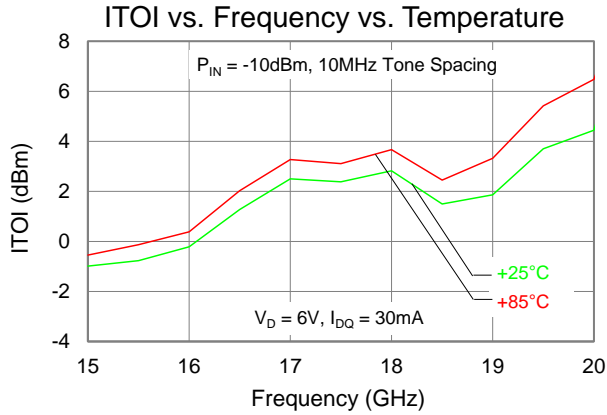

Typical Performance (Harmonics)

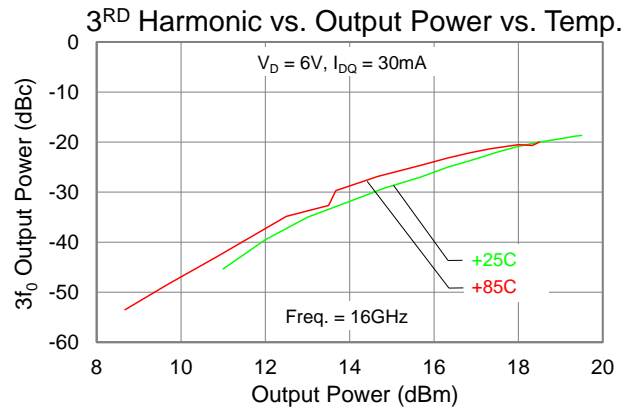
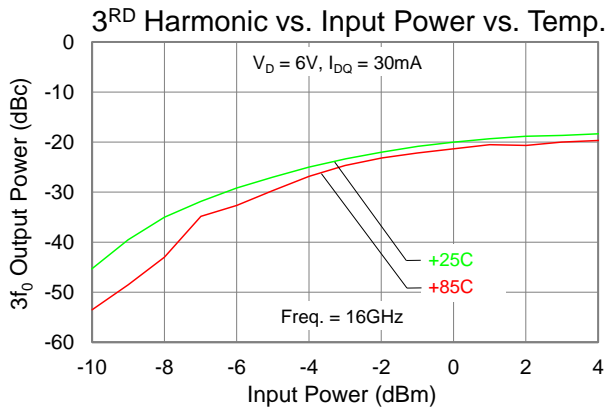
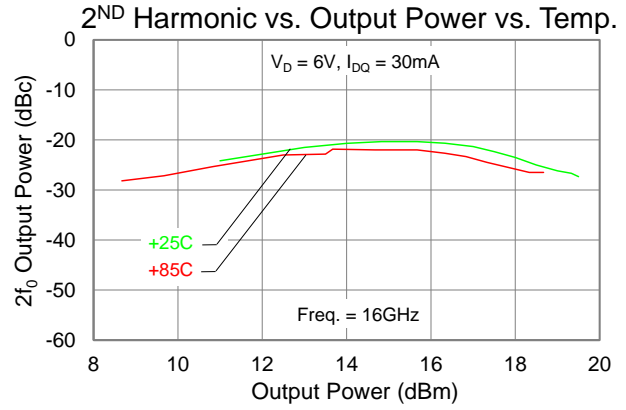
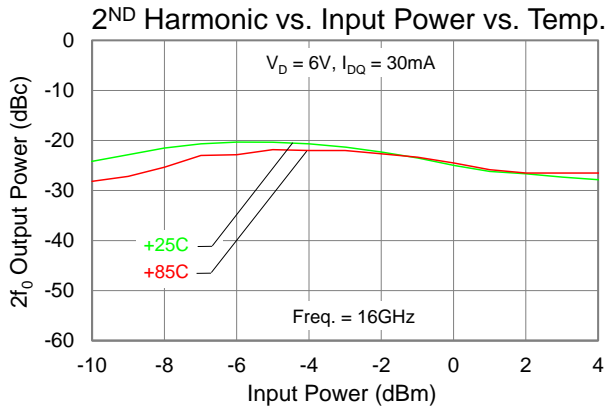

Application Circuit

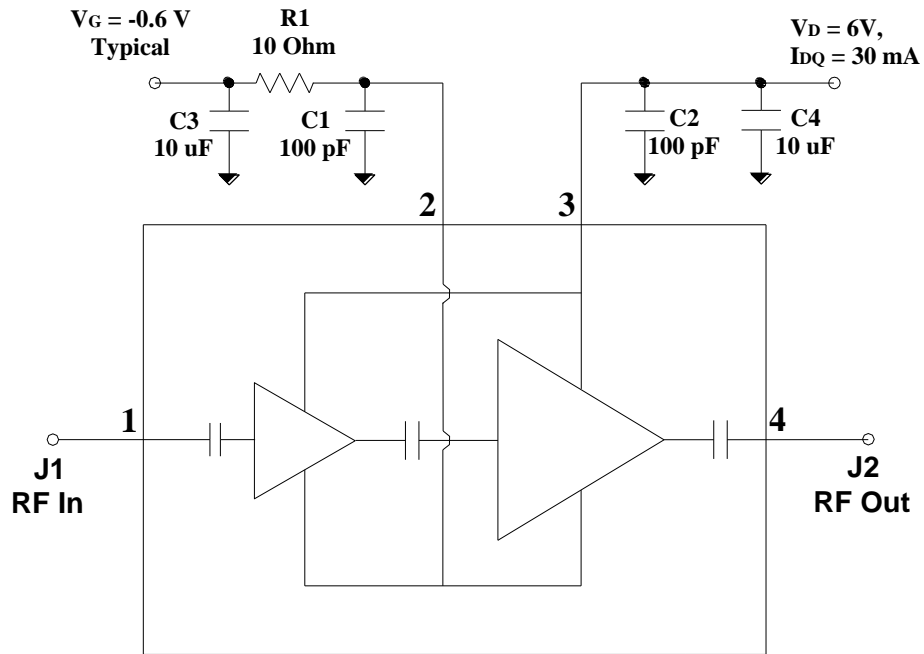

Bias-up Procedure

1. Set I_D limit to 60mA, I_G limit to 4mA
2. Apply -1.5V to V_G
3. Apply +6V to V_D
4. Adjust V_G more positive until $I_{DQ} = 30\text{ mA}$ ($V_G \sim -0.6\text{ V}$ Typical)
5. Apply RF signal

Bias-down Procedure

1. Turn off RF signal
2. Reduce V_G to -1.5V. Ensure $I_{DQ} \sim 0\text{ mA}$
3. Set V_D to 0V
4. Turn off V_D supply
5. Turn off V_G supply

Assembly Drawing

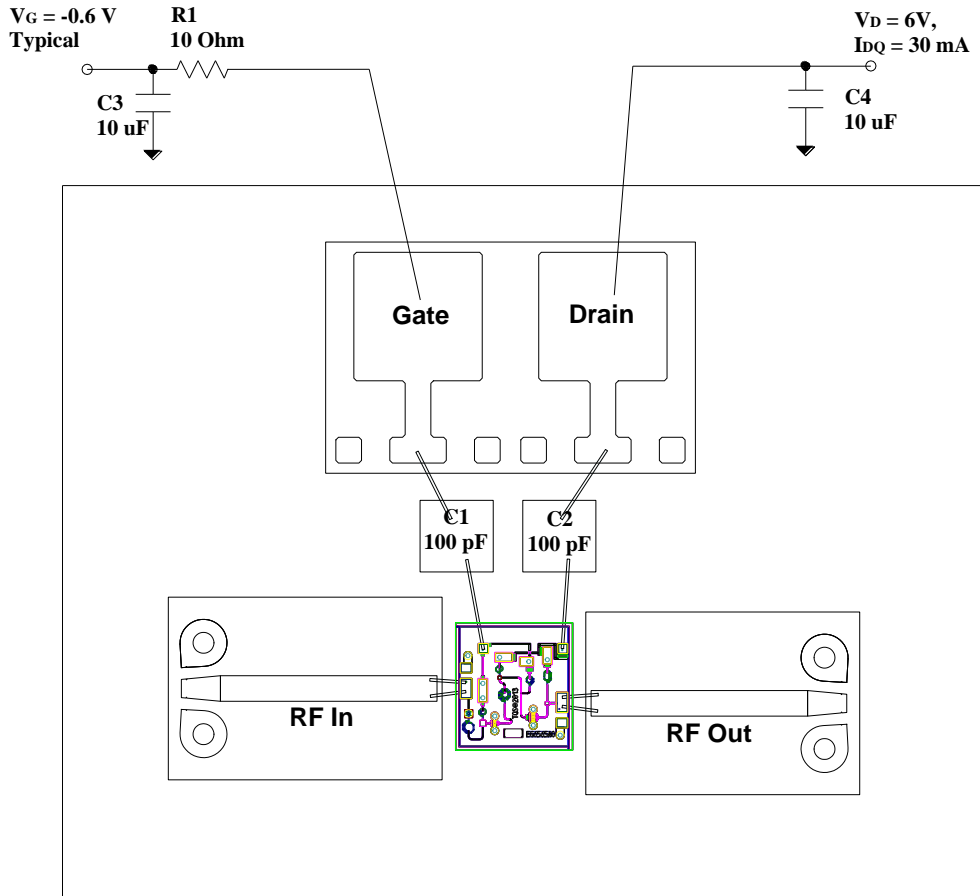

Bill of Material

Reference Des.	Value	Description	Manuf.	Part Number
C1 – C2	100pF	Cap, 50V, 25%, Single Layer Cap	Various	
C3 – C4	10μF	Cap, 1206, 50V, 20%, X5R	Various	
R1	10Ω	Res, 0603, 5%	Various	

Mechanical Drawing & Bond Pad Description

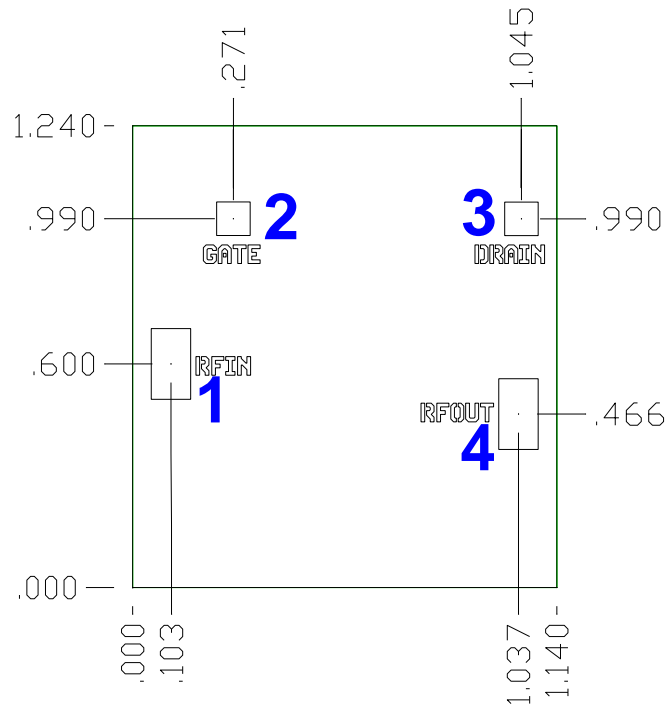

Unit: millimeters
 Thickness: 0.10
 Die x, y size tolerance: +/- 0.050
 Chip edge to bond pad dimensions are shown to center of pad
 Ground is backside of die

Bond Pad	Symbol	Pad Size	Description
1	RF In	0.106 x 0.190	Input; matched to 50 ohms; DC blocked.
2	V _G	0.090 x 0.090	Gate voltage, bias network is required; see Application Circuit on page 9 as an example.
3	V _D	0.090 x 0.090	Drain voltage, bias network is required; see Application Circuit on page 9 as an example.
4	RF Out	0.106 x 0.190	Output; matched to 50 ohms; DC blocked.

Assembly Notes

Component placement and adhesive attachment assembly notes:

- Vacuum pencils and/or vacuum collets are the preferred method of pick up.
- Air bridges must be avoided during placement.
- The force impact is critical during auto placement.
- Organic attachment (i.e. epoxy) can be used in low-power applications.
- Curing should be done in a convection oven; proper exhaust is a safety concern.

Reflow process assembly notes:

- Use AuSn (80/20) solder and limit exposure to temperatures above 300°C to 3-4 minutes, maximum.
- An alloy station or conveyor furnace with reducing atmosphere should be used.
- Do not use any kind of flux.
- Coefficient of thermal expansion matching is critical for long-term reliability.
- Devices must be stored in a dry nitrogen atmosphere.

Interconnect process assembly notes:

- Thermosonic ball bonding is the preferred interconnect technique.
- Force, time, and ultrasonic are critical parameters.
- Aluminum wire should not be used.
- Devices with small pad sizes should be bonded with 0.0007-inch wire.

Product Compliance Information**ESD Sensitivity Ratings**

Caution! ESD-Sensitive Device

ESD Rating: TBD
Value: TBD
Test: Human Body Model (HBM)
Standard: JEDEC Standard JESD22-A114

ECCN

US Department of Commerce: EAR99

Solderability

Use AuSn (80/20) solder and limit exposure to temperature above 300°C to 3-4 minutes, maximum.

RoHS Compliance

This part is compliant with EU 2002/95/EC RoHS directive (Restrictions on the Use of Certain Hazardous Substances in Electrical and Electronic Equipment).

This product also has the following attributes:

- Lead Free
- Halogen Free (Chlorine, Bromine)
- Antimony Free
- TBBP-A (C₁₅H₁₂Br₄O₂) Free
- PFOS Free
- SVHC Free

Contact Information

For the latest specifications, additional product information, worldwide sales and distribution locations, and information about TriQuint:

Web: www.triquint.com
Email: info-sales@triquint.com

Tel: +1.972.994.8465
Fax: +1.972.994.8504

For technical questions and application information: Email: info-products@triquint.com**Important Notice**

The information contained herein is believed to be reliable. TriQuint makes no warranties regarding the information contained herein. TriQuint assumes no responsibility or liability whatsoever for any of the information contained herein. TriQuint assumes no responsibility or liability whatsoever for the use of the information contained herein. The information contained herein is provided "AS IS, WHERE IS" and with all faults, and the entire risk associated with such information is entirely with the user. All information contained herein is subject to change without notice. Customers should obtain and verify the latest relevant information before placing orders for TriQuint products. The information contained herein or any use of such information does not grant, explicitly or implicitly, to any party any patent rights, licenses, or any other intellectual property rights, whether with regard to such information itself or anything described by such information.

TriQuint products are not warranted or authorized for use as critical components in medical, life-saving, or life-sustaining applications, or other applications where a failure would reasonably be expected to cause severe personal injury or death.