



SGM4812

132mW Differential Input, Stereo Audio Power Amplifier

GENERAL DESCRIPTION

The SGM4812 is a stereo audio power amplifier with differential inputs. Operating on a single 5V power supply, it delivers 132mW of continuous RMS power per channel into a 16Ω loads with typically 0.1% THD+N. Amplifier gain is externally configured by means of two resistors per input channel and does not require external compensation.

The SGM4812 is designed to maximize audio performance in portable communication device applications such as mobile phone. The portable application requires audio power amplifier has minimum of external components and can operate from a single 2.7V to 5.5V power supply.

The SGM4812 features an externally controlled, active-high, micro-power consumption shutdown mode. Additionally, the SGM4812 features an internal thermal shutdown and short circuit protection mechanism.

The SGM4812 is available in Green MSOP-10 package. It operates over an ambient temperature range of -40°C to +85°C.

FEATURES

- **Dual Channel, Differential Inputs**
- **132mW into 16Ω Load from 5V Power Supply at THD+N = 0.1% (Typical, per Channel)**
- **82mW into 32Ω Load from 5V Power Supply at THD+N = 0.1% (Typical, per Channel)**
- **2.7V to 5.5V Operation**
- **Thermal Shutdown and Short Circuit Protection**
- **Internal Pop Reduction Circuitry**
- **Internal Mid-Rail Generation**
- **Low Shutdown Current: 0.36μA (TYP) at 5V**
- **Shutdown Pin is Compatible with 1.8V Logic**
- **-40°C to +85°C Operating Temperature Range**
- **Available in Green MSOP-10 Package**

APPLICATIONS

Portable Electronic Systems
Notebook Computers
Mobile Phones
PDAs
GPS



SGM4812

132mW Differential Input, Stereo Audio Power Amplifier

PACKAGE/ORDERING INFORMATION

MODEL	ORDER NUMBER	PACKAGE DESCRIPTION	PACKAGE OPTION	MARKING INFORMATION
SGM4812	SGM4812YMS10/TR	MSOP-10	Tape and Reel, 3000	SGM4812YMS10

ABSOLUTE MAXIMUM RATINGS

Supply Voltage.....	6V
Input Voltage.....	-0.3V to (V ₊) + 0.3V
Storage Temperature Range.....	-65°C to +150°C
Junction Temperature.....	150°C
Operating Temperature Range.....	-40°C to +85°C
Lead Temperature Range (Soldering 10sec)	260°C
ESD Susceptibility	
HBM.....	4000V
MM.....	400V

NOTE:

Stresses beyond those listed under “Absolute Maximum Ratings” may cause permanent damage to the device. These are stress ratings only, and functional operation of the device at these or any other conditions beyond those indicated in the operational sections of the specifications is not implied. Exposure to absolute maximum rating conditions for extended periods may affect device reliability.

CAUTION

This integrated circuit can be damaged by ESD if you don't pay attention to ESD protection. SGMICRO recommends that all integrated circuits be handled with appropriate precautions. Failure to observe proper handling and installation procedures can cause damage. ESD damage can range from subtle performance degradation to complete device failure. Precision integrated circuits may be more susceptible to damage because very small parametric changes could cause the device not to meet its published specifications.

SGMICRO reserves the right to make any change in circuit design, specification or other related things if necessary without notice at any time. Please contact SGMICRO sales office to get the latest datasheet.

PIN CONFIGURATION (TOP VIEW)

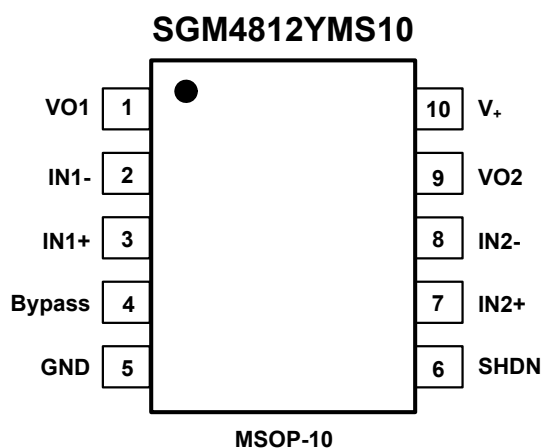

ELECTRICAL CHARACTERISTICS(T_A = +25°C, unless otherwise specified.)

PARAMETER	SYMBOL	CONDITIONS		MIN	TYP	MAX	UNITS
Supply Voltage	V ₊			2.7		5.5	V
Shutdown Current	I _{SD}	V _{IN} = 0V, V _{SHDN} = V ₊	V ₊ = 5V		0.36	2	μA
			V ₊ = 3.3V		0.13	2	
			V ₊ = 2.7V		0.07		
Output Offset Voltage	V _{OS}	V _{IN} = 0V		-15	2	15	mV
Quiescent Power Supply Current	I _Q	V _{IN} = 0V, I _O = 0A	V ₊ = 5V		1.86	2.6	mA
			V ₊ = 3.3V		1.58	2.5	
			V ₊ = 2.7V		1.50		
Shutdown Voltage Input High	V _{SDIH}			1.8			V
Shutdown Voltage Input Low	V _{SDIL}					0.4	
Power Supply Rejection Ratio	PSRR	V ₊ = 3.2V to 3.4V			74		dB
		V ₊ = 4.9V to 5.1V			70		
Output Power (per Channel)	P _O	f = 1kHz, THD+N = 0.1%	V ₊ = 5V	R _L = 16Ω		132	mW
				R _L = 32Ω		82	
			V ₊ = 3.3V	R _L = 16Ω		46	
				R _L = 32Ω		34	
			V ₊ = 3.0V	R _L = 16Ω		34	
				R _L = 32Ω		27	
V ₊ = 2.7V	R _L = 16Ω		22				
	R _L = 32Ω		21				
Total Harmonic Distortion + Noise	THD+N	P _O = 60mW, V ₊ = 5V, R _L = 32Ω, f = 20Hz to 20kHz			0.07		%
Power Supply Rejection Ratio	PSRR	f = 217Hz, R _L = 32Ω, Input grounded with 10Ω, (C _{BYPASS} = 0.47μF)	V ₊ = 5V		-55		dB
			V ₊ = 3.3V		-55		
			V ₊ = 3.0V		-55		
			V ₊ = 2.7V		-55		
		f = 1kHz, R _L = 32Ω, Input grounded with 10Ω, (C _{BYPASS} = 0.47μF)	V ₊ = 5V		-71		
			V ₊ = 3.3V		-71		
			V ₊ = 3.0V		-71		
			V ₊ = 2.7V		-71		
Wake-Up Time	T _{WU}	V ₊ = 5V, C _{BYPASS} = 0.47μF			1.8		s
Signal-to-Noise Ratio	SNR	V ₊ = 5V, R _L = 32Ω, P _O = 60mW, BW < 80kHz			-96		dB
Crosstalk	X _{TALK}	V ₊ = 5V, R _L = 32Ω, P _O = 60mW, f = 1kHz			-75		dB

TYPICAL PERFORMANCE CHARACTERISTICS

Small Signal Step Response

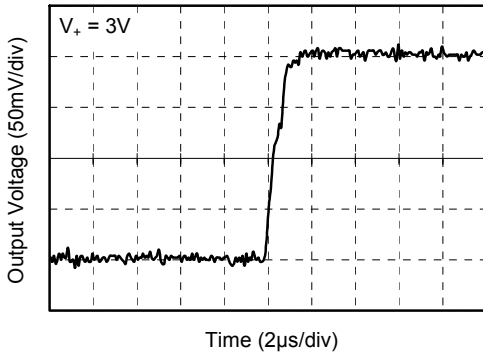

Small Signal Step Response

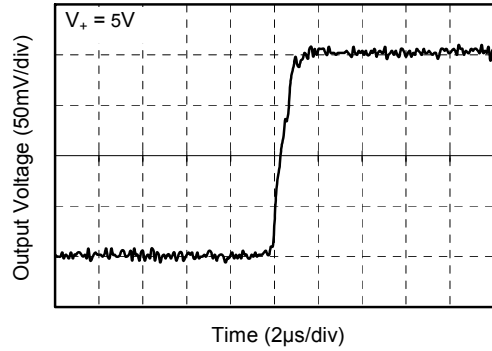

THD+N vs. Frequency

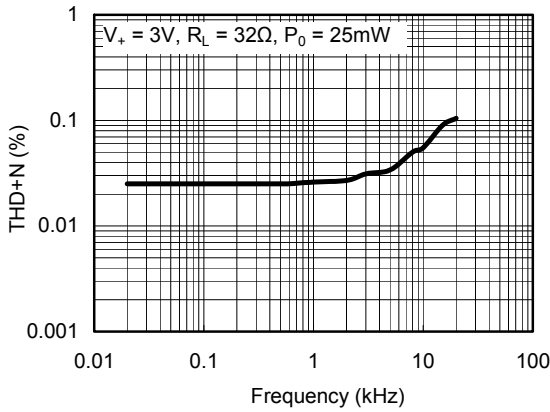

THD+N vs. Frequency

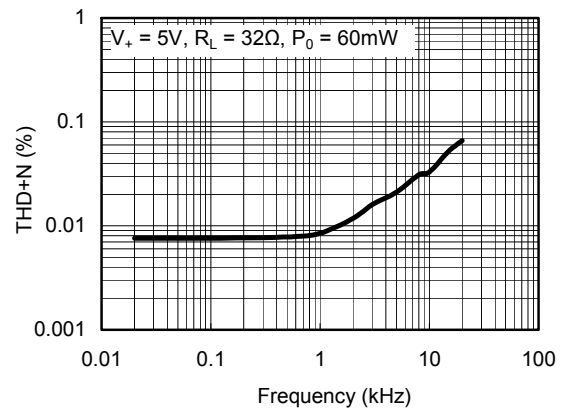

THD+N vs. Frequency

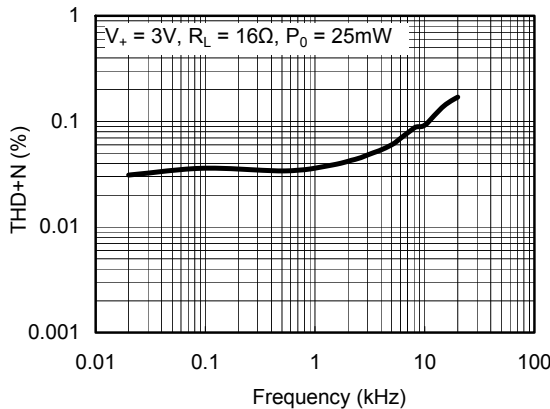

THD+N vs. Frequency

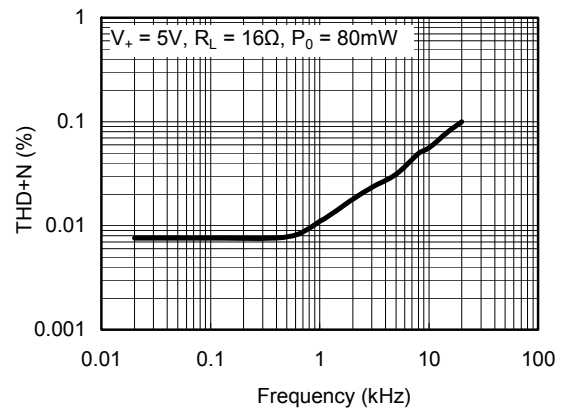

TYPICAL PERFORMANCE CHARACTERISTICS

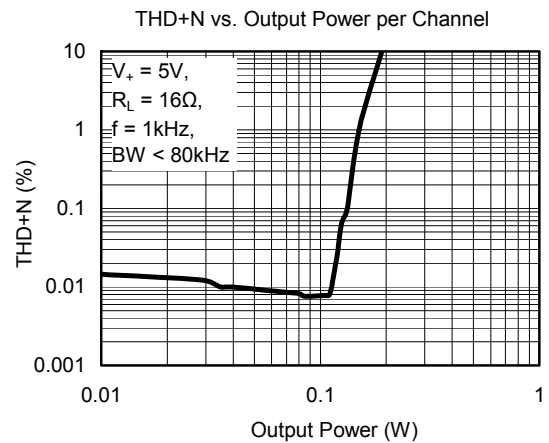
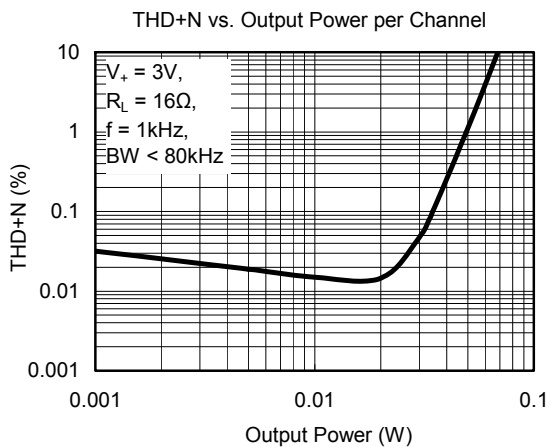
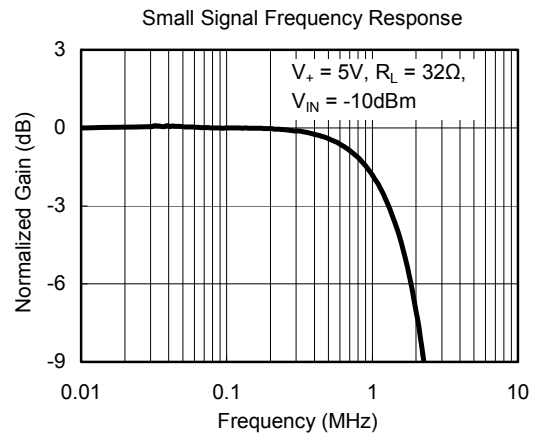
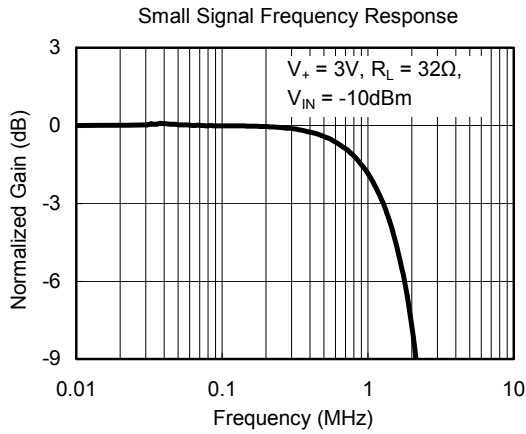
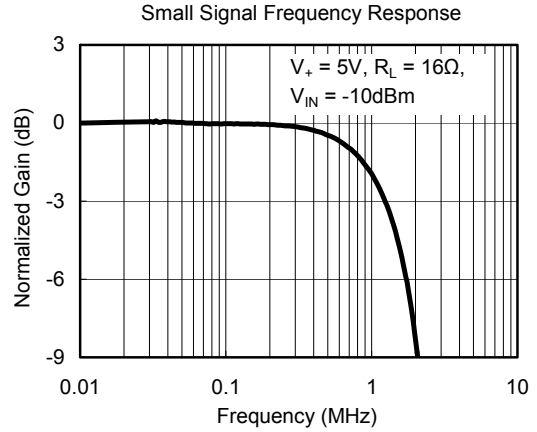
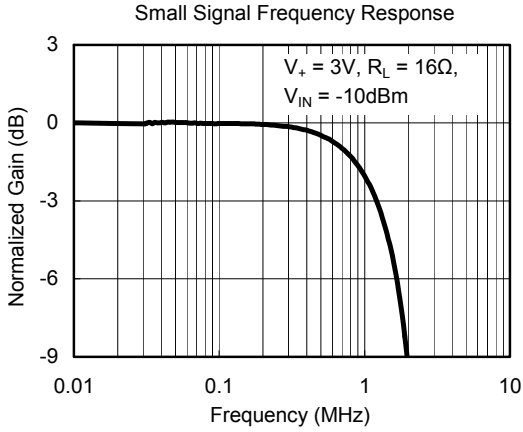

TYPICAL PERFORMANCE CHARACTERISTICS

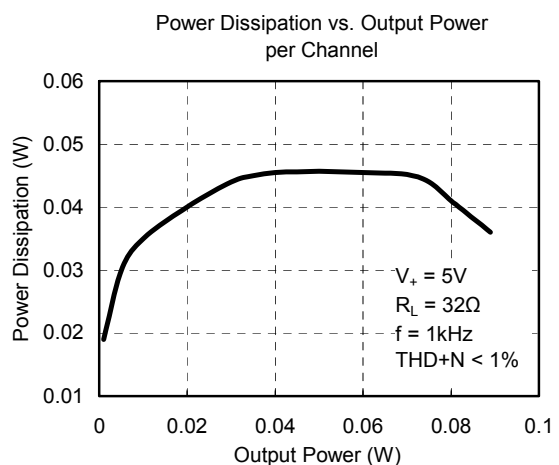
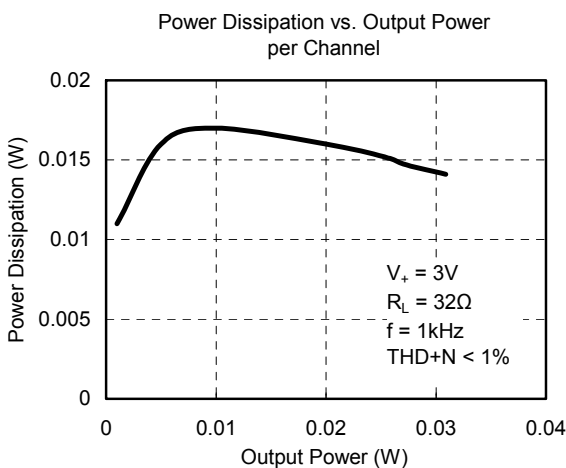
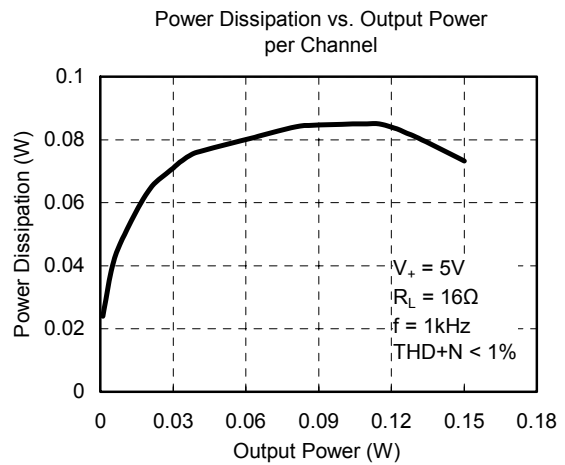
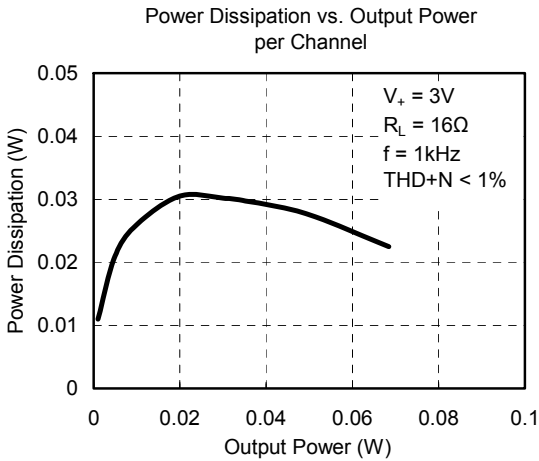
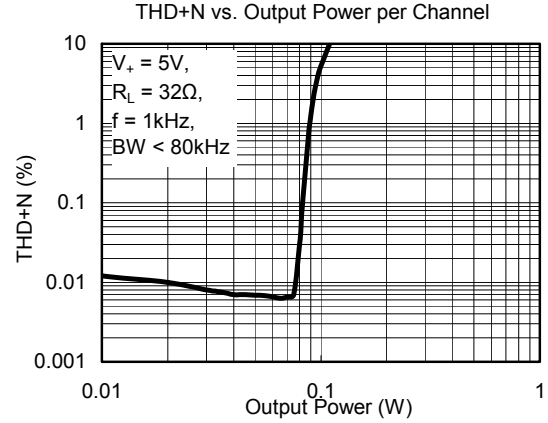
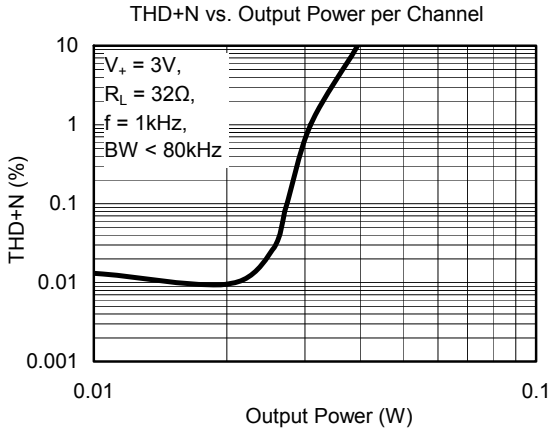

TYPICAL PERFORMANCE CHARACTERISTICS

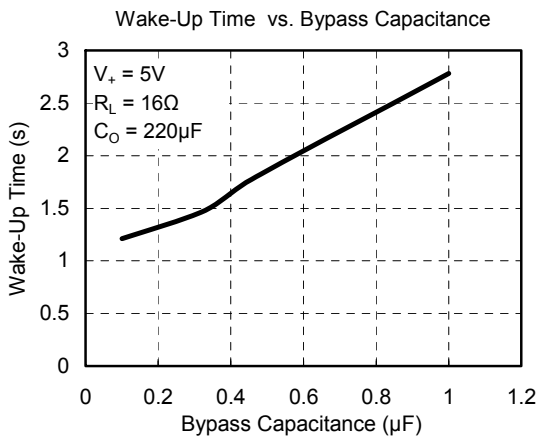
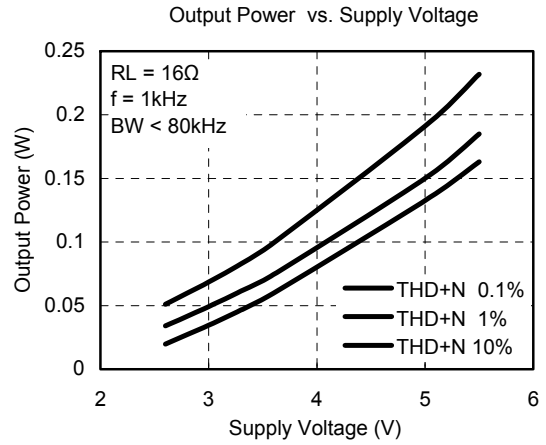
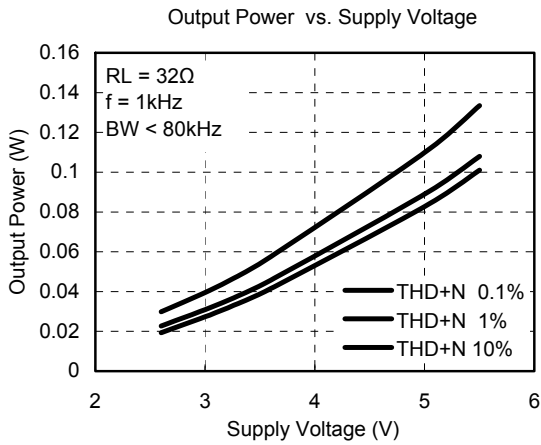

TYPICAL APPLICATION

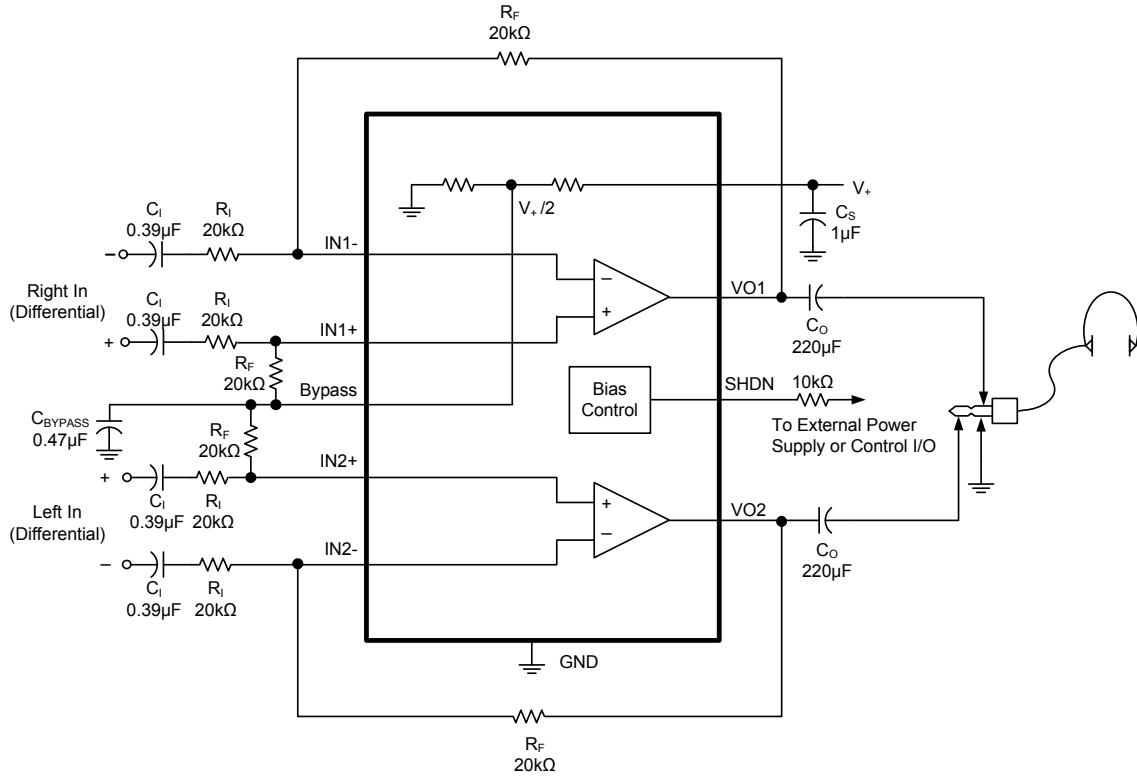

NOTE:

1. A 10kΩ resistor must be serially connected to SHDN pin.

PACKAGE OUTLINE DIMENSIONS

MSOP-10

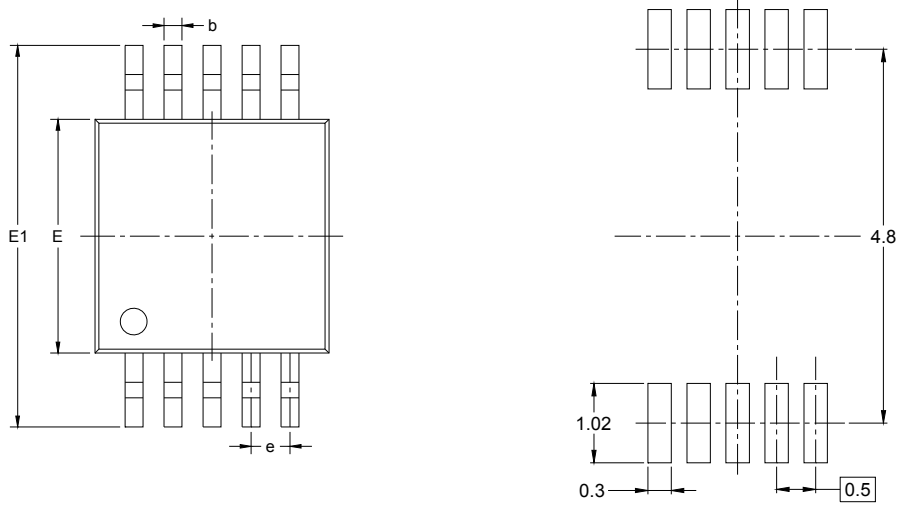

RECOMMENDED LAND PATTERN (Unit: mm)

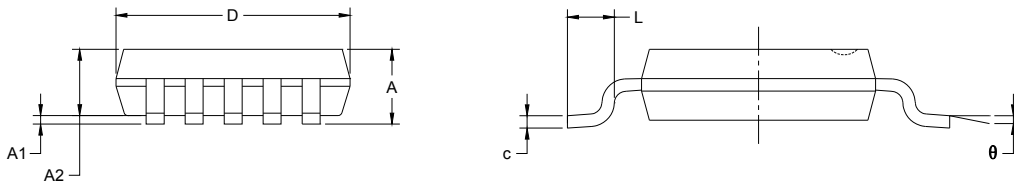

Symbol	Dimensions In Millimeters		Dimensions In Inches	
	MIN	MAX	MIN	MAX
A	0.820	1.100	0.032	0.043
A1	0.020	0.150	0.001	0.006
A2	0.750	0.950	0.030	0.037
b	0.180	0.280	0.007	0.011
c	0.090	0.230	0.004	0.009
D	2.900	3.100	0.114	0.122
E	2.900	3.100	0.114	0.122
E1	4.750	5.050	0.187	0.199
e	0.500 BSC		0.020 BSC	
L	0.400	0.800	0.016	0.031
θ	0°	6°	0°	6°

TAPE AND REEL INFORMATION

REEL DIMENSIONS

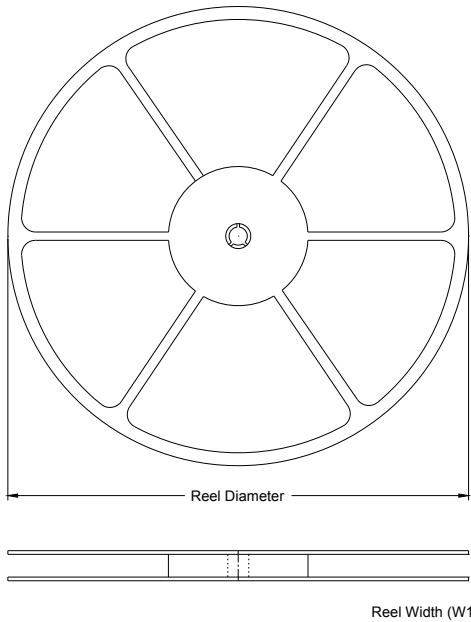

TAPE DIMENSIONS

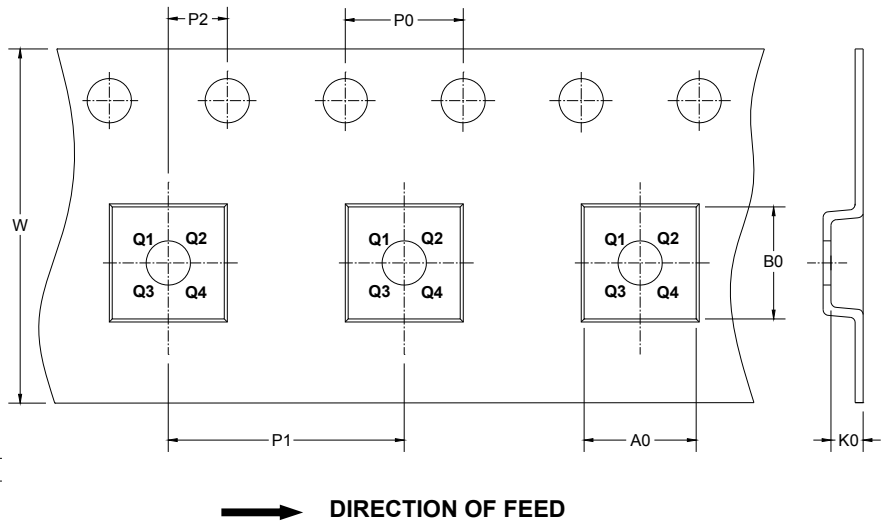

NOTE: The picture is only for reference. Please make the object as the standard.

KEY PARAMETER LIST OF TAPE AND REEL

Package Type	Reel Diameter	Reel Width W1 (mm)	A0 (mm)	B0 (mm)	K0 (mm)	P0 (mm)	P1 (mm)	P2 (mm)	W (mm)	Pin1 Quadrant
MSOP-10	13"	12.4	5.2	3.3	1.2	4.0	8.0	2.0	12.0	Q1

SGM4812

132mW Differential Input, Stereo Audio Power Amplifier

CARTON BOX DIMENSIONS

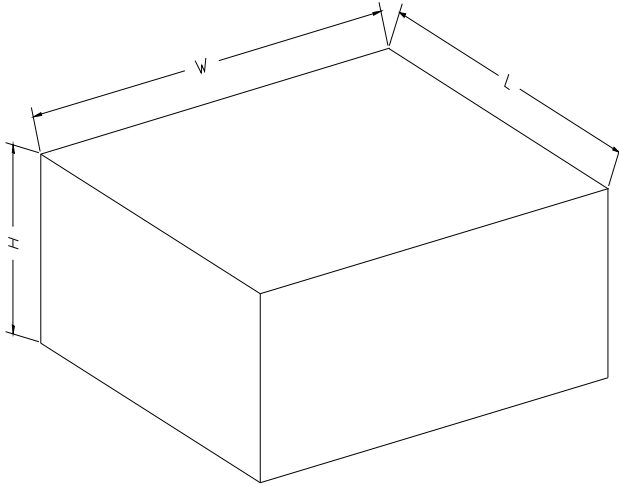

NOTE: The picture is only for reference. Please make the object as the standard.

KEY PARAMETER LIST OF CARTON BOX

Reel Type	Length (mm)	Width (mm)	Height (mm)	Pizza/Carton
13"	386	280	370	5