

13 - 17 GHz 2 Watt, 32dB Power Amplifier

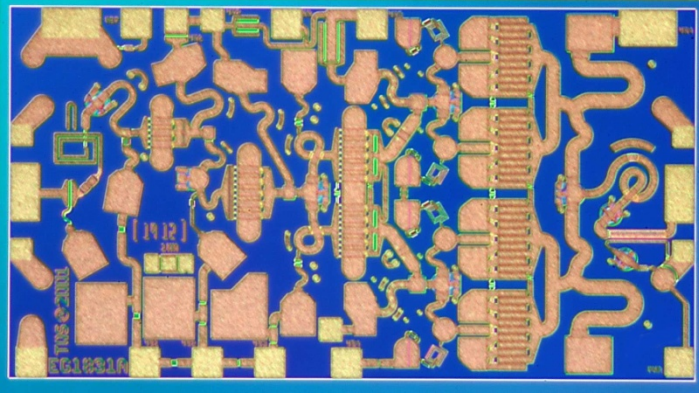

Key Features and Performance

- 33 dBm Midband Pout
- 32 dB Nominal Gain
- 10 dB Typical Return Loss
- Built-in Directional Power Detector with Reference
- 0.50 μ m pHEMT Technology
- Bias Conditions: 7 V, 680mA
- Chip dimensions: 2.5 x 1.4 x 0.1 mm (98 x 55 x 4 mils)

Preliminary Measured Data

Bias Conditions: $V_d=7$ V $I_d=680$ mA

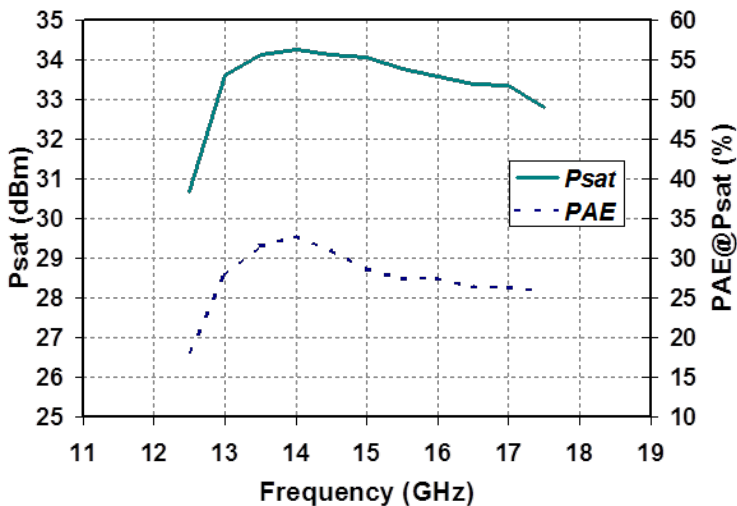
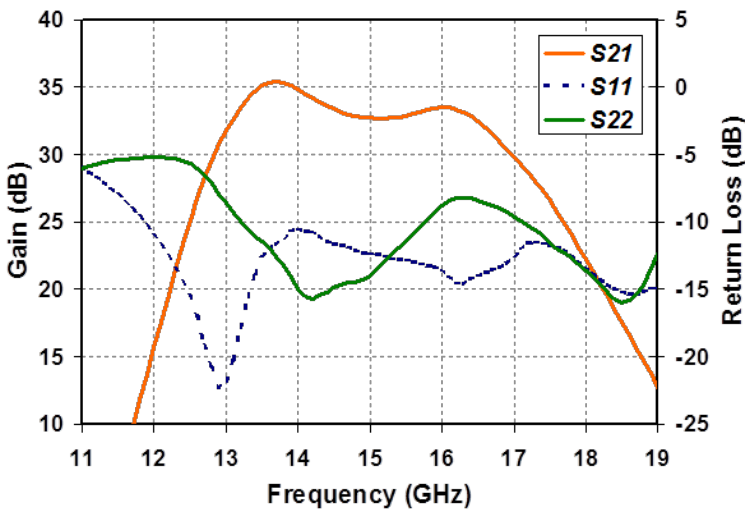

Primary Applications

- VSAT
- Point-to-Point

Note: Datasheet is subject to change without notice.

Table I
Absolute Maximum Ratings 1/

Symbol	Parameter	Value	Notes
Vd-Vg	Drain to Gate Voltage	13 V	
Vd	Drain Voltage	8 V	<u>2/</u>
Vg	Gate Voltage Range	-5 to 0 V	
Id	Drain Current	1300 mA	<u>2/</u>
Ig	Gate Current Range	-18 to 18 mA	
Pin	Input Continuous Wave Power	21 dBm	<u>2/</u>
Tchannel	Channel Temperature	200 °C	

1/ These ratings represent the maximum operable values for this device. Stresses beyond those listed under “Absolute Maximum Ratings” may cause permanent damage to the device and/or affect device lifetime. These are stress ratings only, and functional operation of the device at these conditions is not implied.

2/ Combinations of supply voltage, supply current, input power, and output power shall not exceed the maximum power dissipation listed in Table IV.

Table II
Recommended Operating Conditions

Symbol	Parameter	Value
Vd	Drain Voltage	7 V
Idq	Drain Current	680 mA
Id_Drive	Drain Current under RF Drive	1200 mA
Vg	Gate Voltage	-0.6 V

TABLE III
RF CHARACTERIZATION TABLE
(T_A = 25 °C, Nominal)
(V_d = 7 V, I_d = 680 mA ±5%)

SYMBOL	PARAMETER	TEST CONDITION	LIMITS			UNITS
			MIN	TYP	MAX	
Gain	Small Signal Gain	F = 13-17		32		dB
IRL	Input Return Loss	F = 13-17		10		dB
ORL	Output Return Loss	F = 13-17		10		dB
PWR	Output Power @ Pin = +5 dBm	F = 13-17		33		dBm

Note: Table III Lists the RF Characteristics of typical devices as determined by fixtured measurements.

Table IV
Power Dissipation and Thermal Properties

Parameter	Test Conditions	Value
Maximum Power Dissipation	Tbaseplate = 70 °C	Pd = 9.2 W Tchannel = 200 °C
Thermal Resistance, θ_{JC}	Vd = 7 V Id = 680 mA Pd = 4.76 W Tbaseplate = 70 °C	θ_{JC} = 14.2 °C/W Tchannel = 138 °C Tm = 2.9E+6 Hrs
Thermal Resistance, θ_{JC} Under RF Drive	Vd = 7 V Id = 1200 mA Pout = 33 dBm Pd = 6.4 W Tbaseplate = 70 °C	θ_{JC} = 14.2 °C/W Tchannel = 161 °C Tm = 4.1E+5 Hrs
Mounting Temperature	30 Seconds	320 °C
Storage Temperature		-65 to 150 °C

Median Lifetime (Tm) vs. Channel Temperature

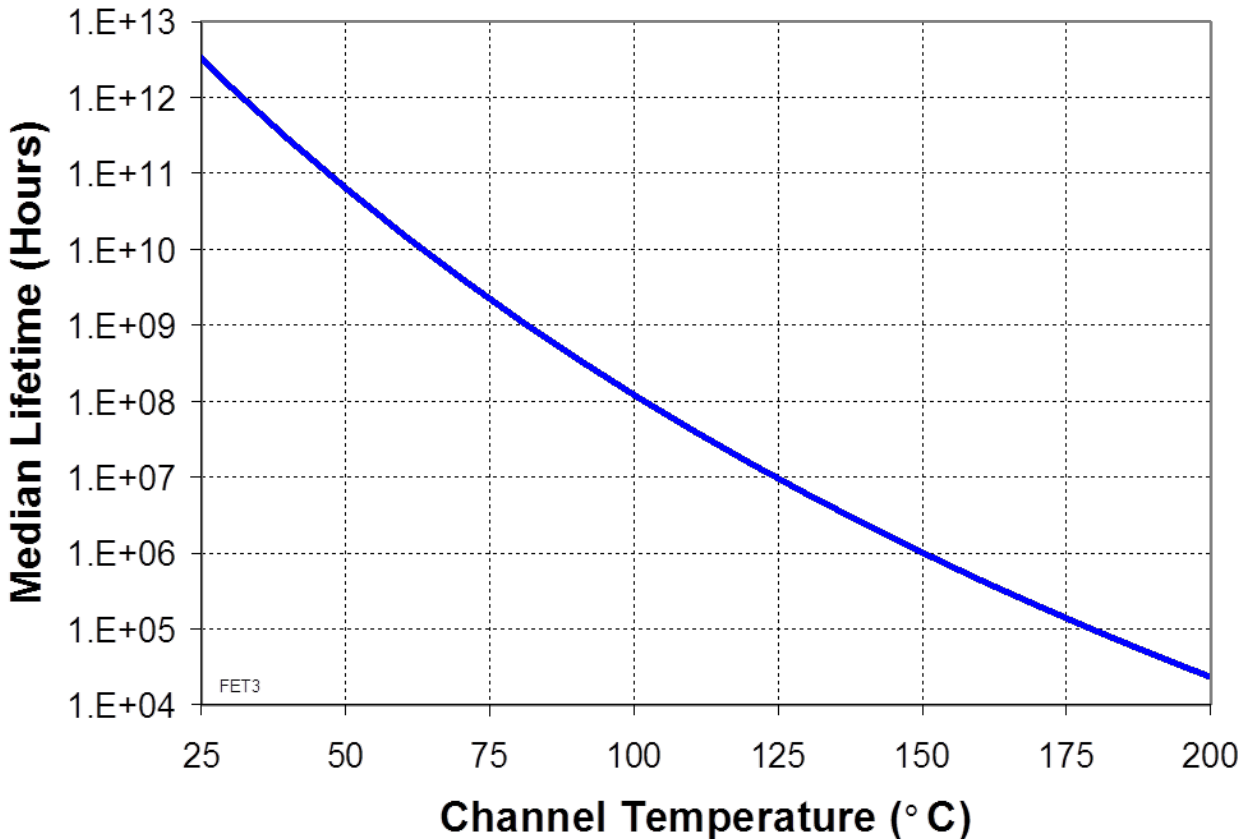

Typical Fixtured Performance

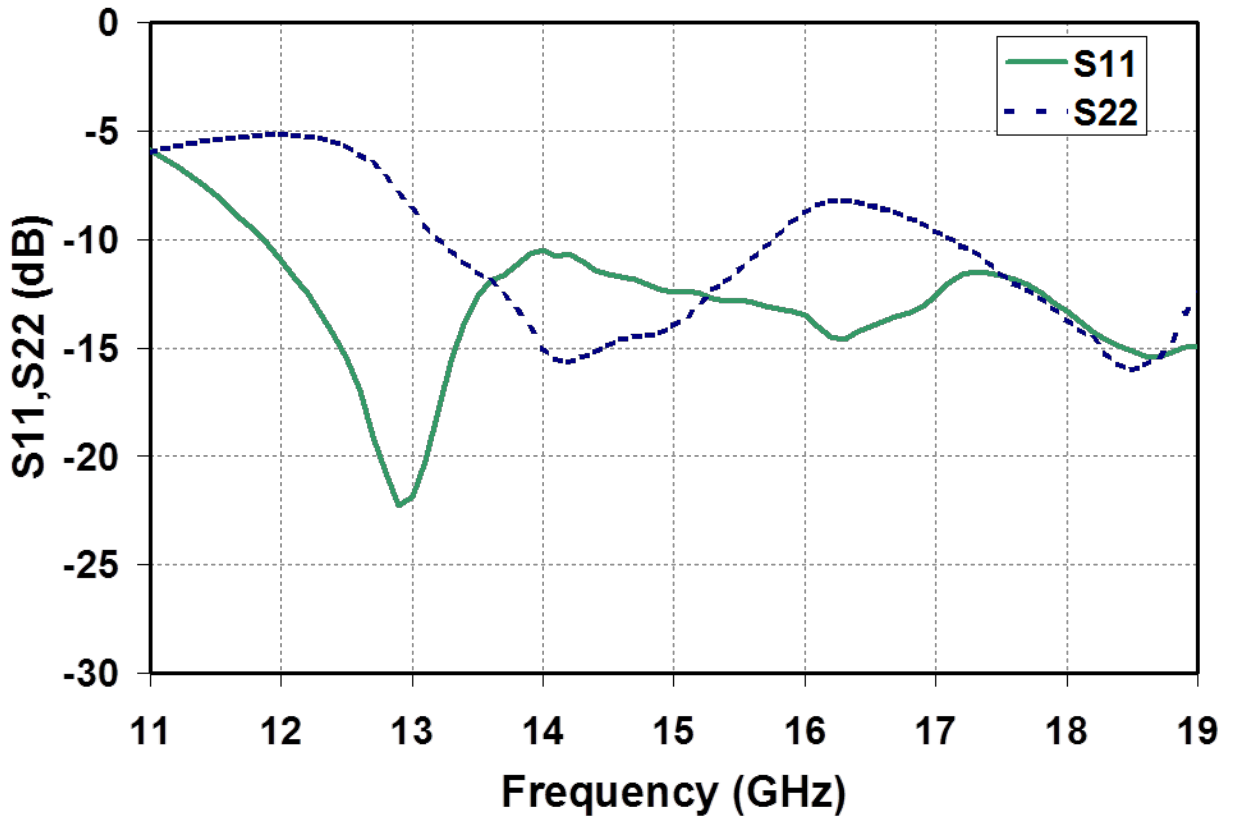
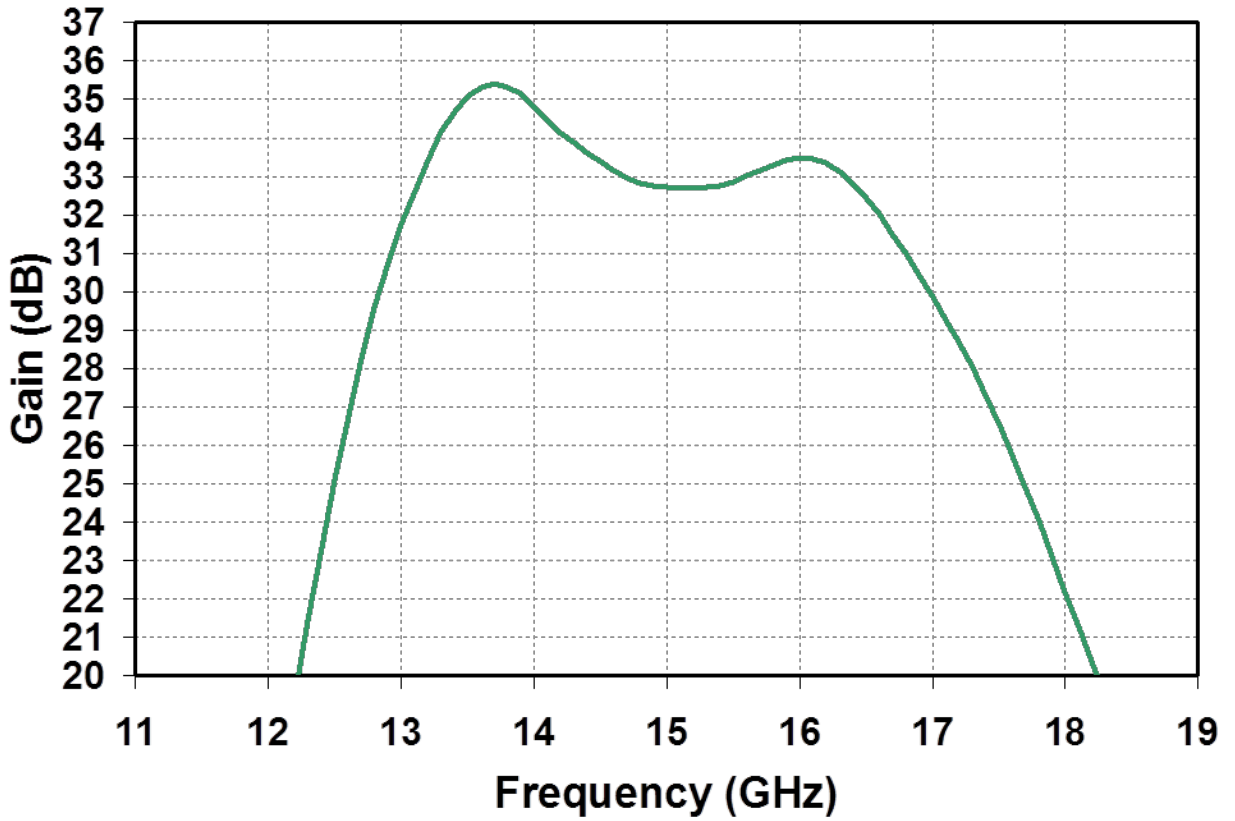

Typical Fixtured Performance

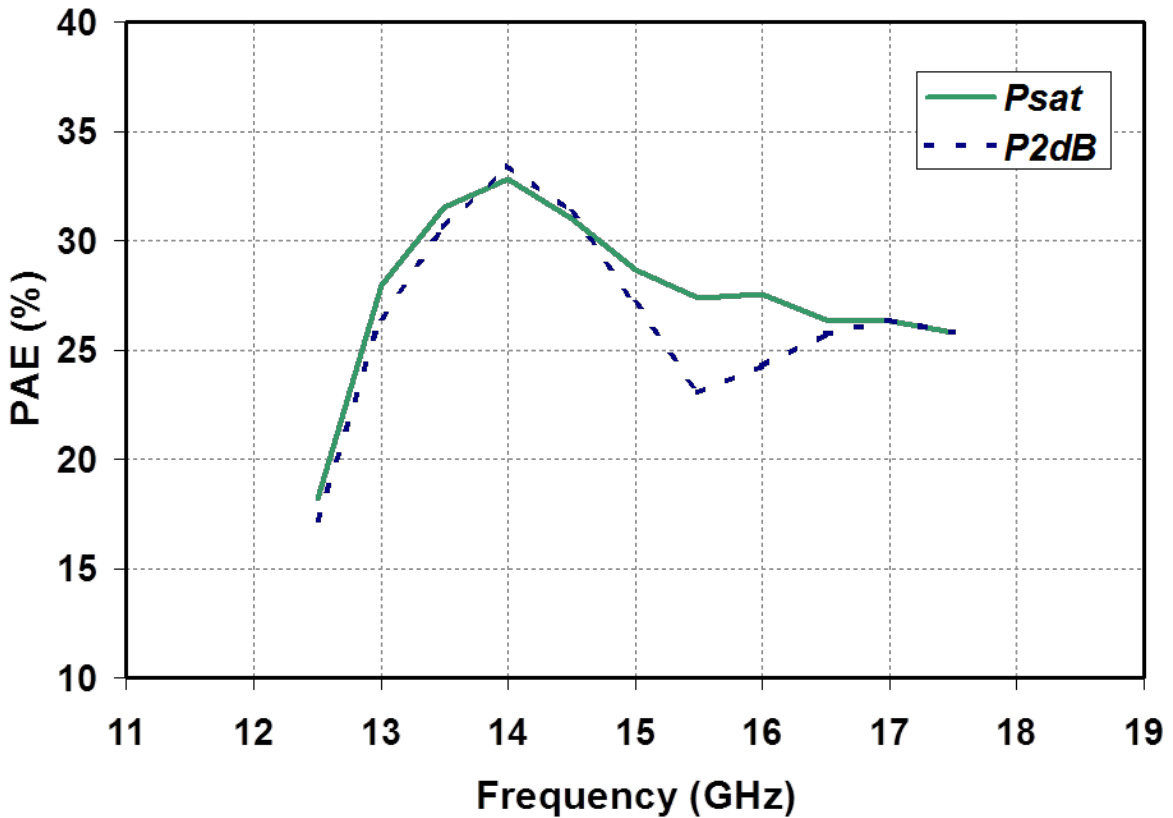
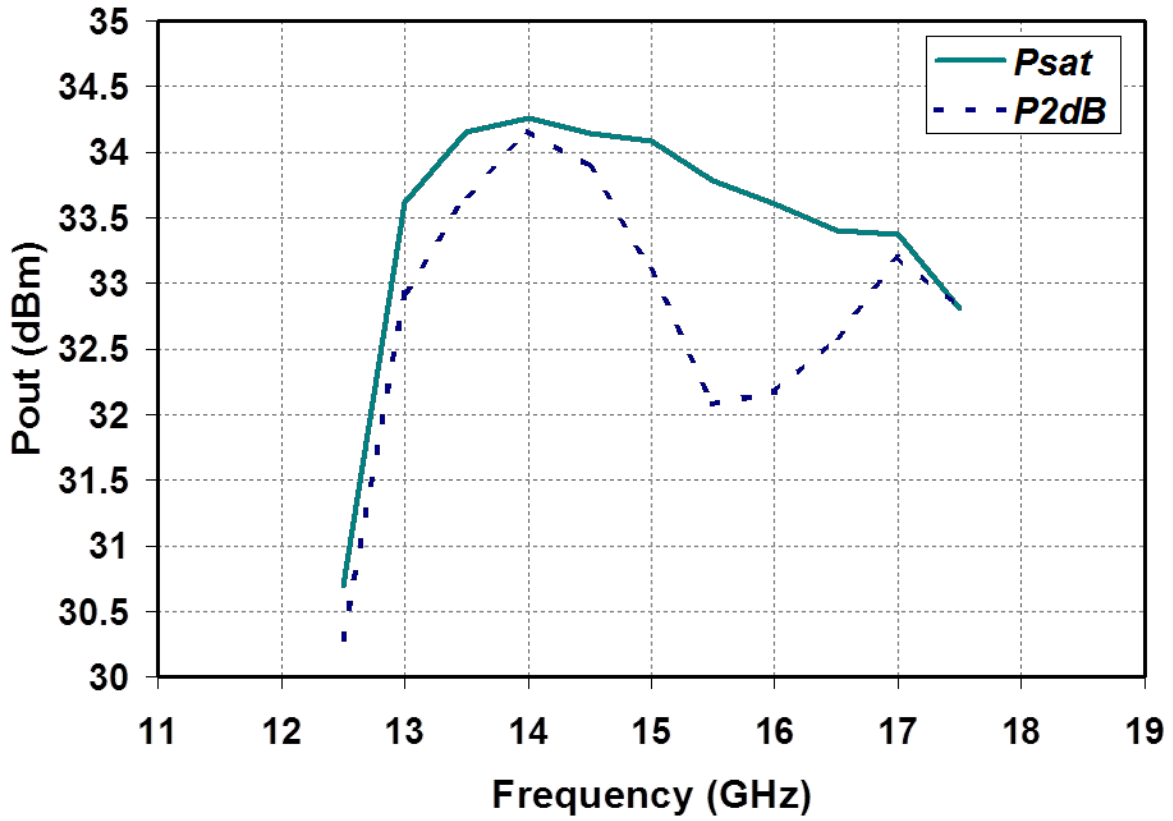

Typical Fixtured Performance

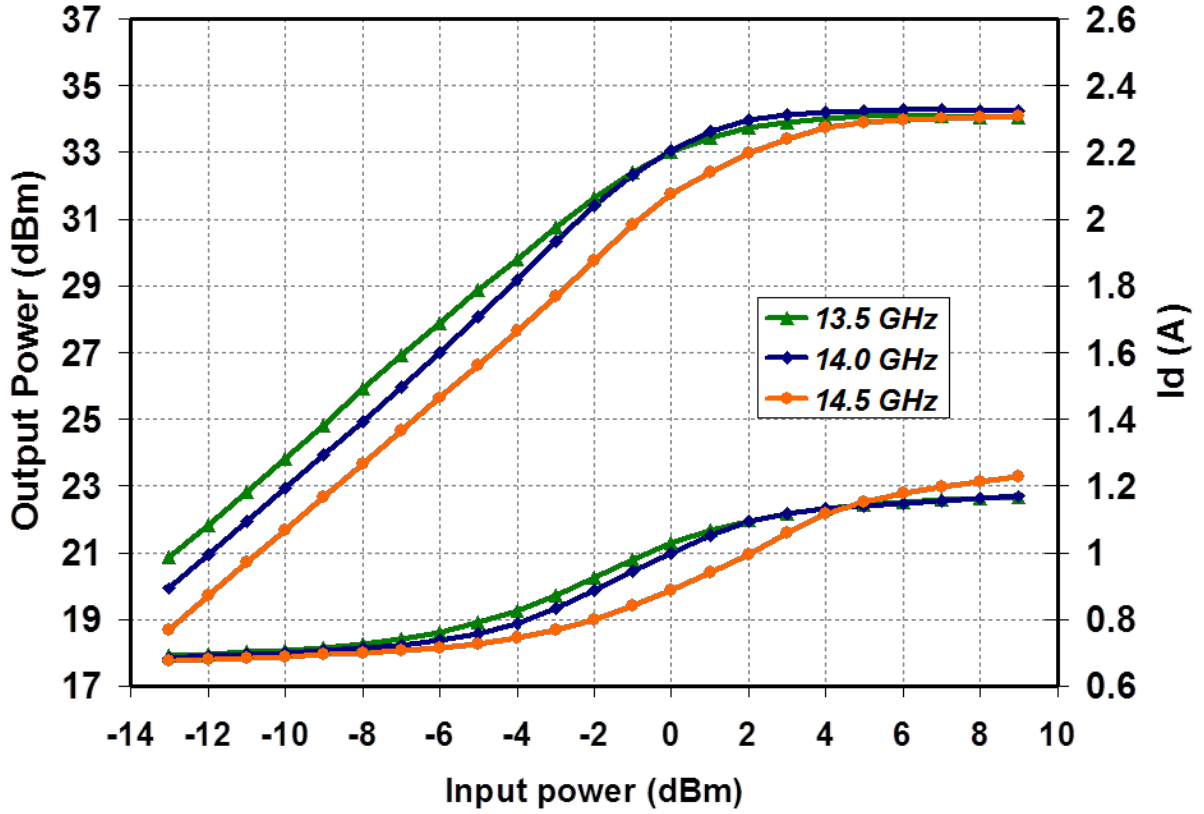

Typical Fixtured Performance

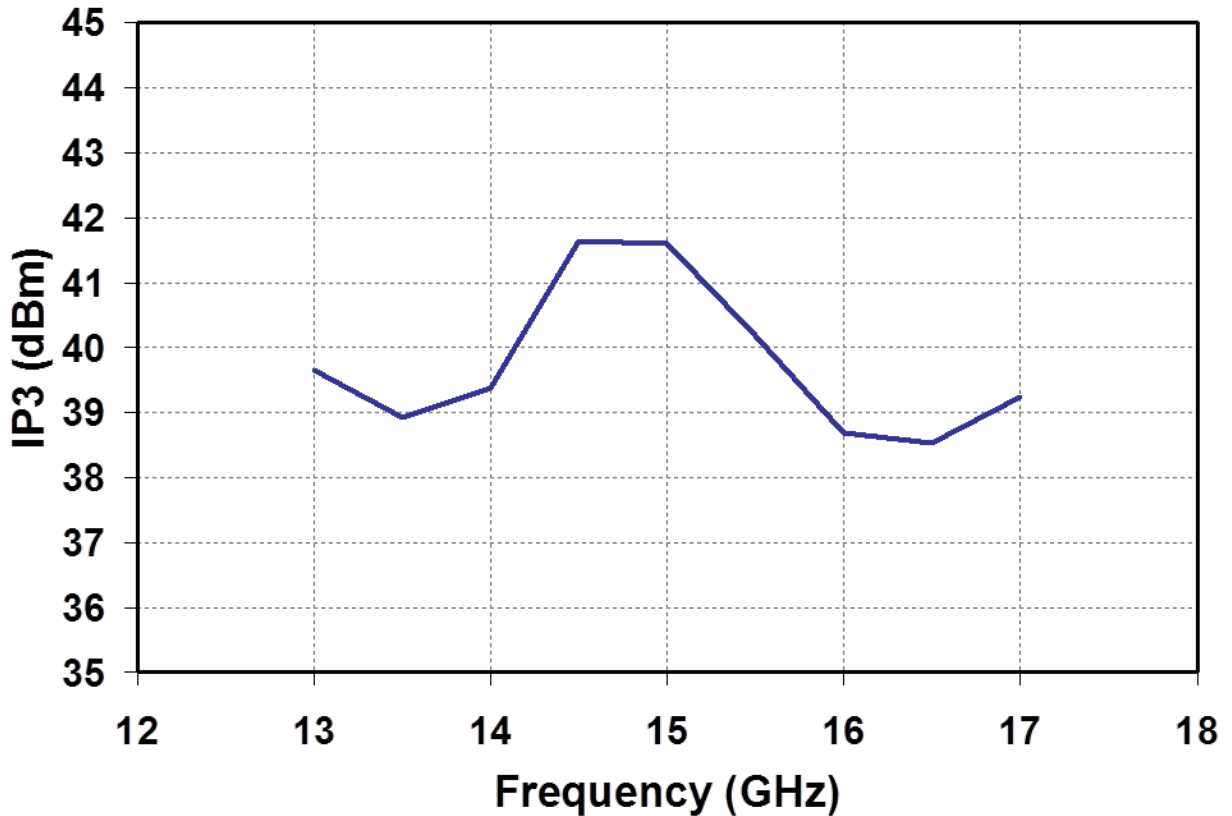
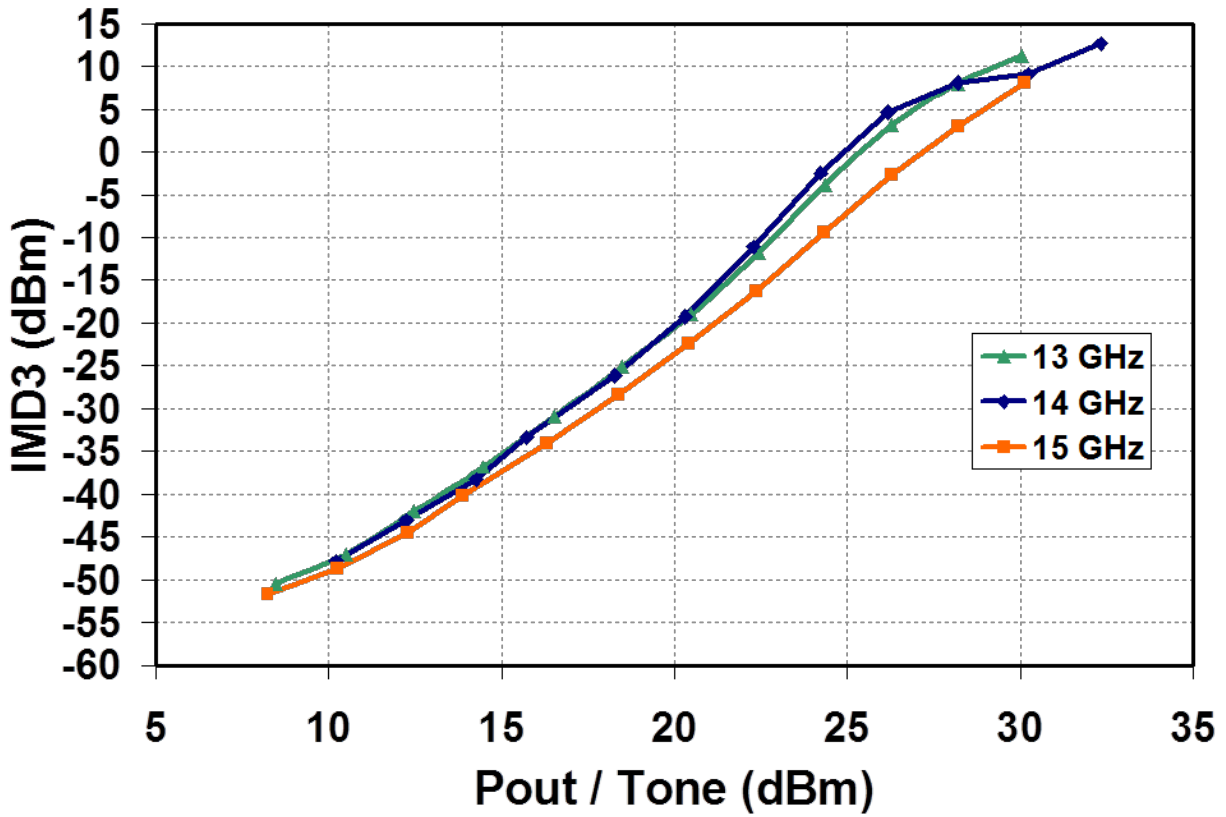

Mechanical Drawing

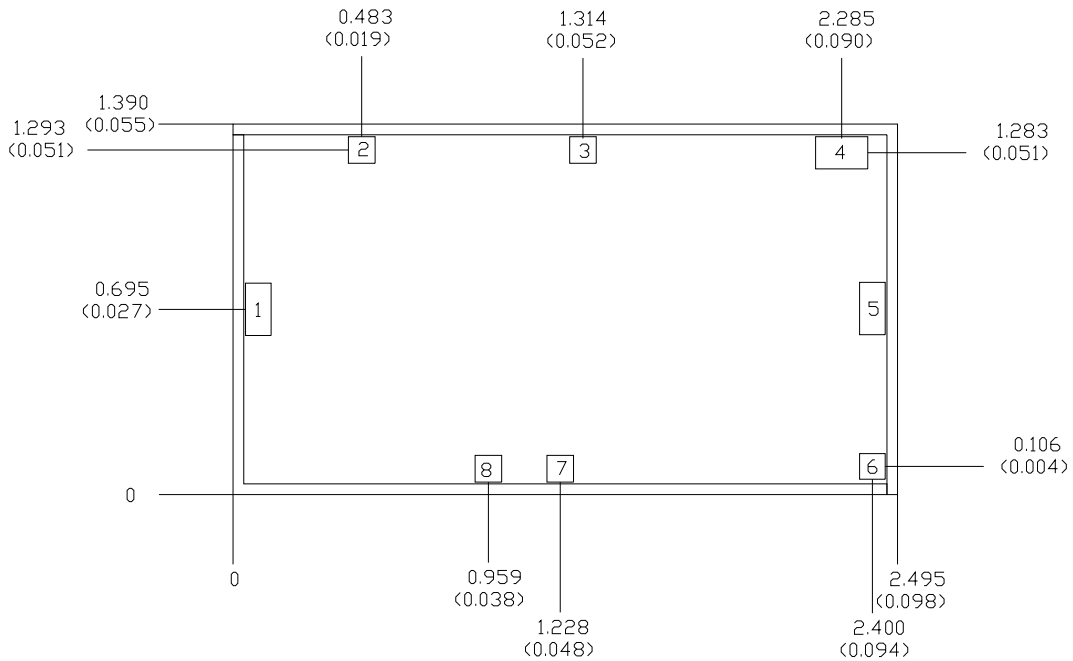

Units: millimeters (inches)

Thickness: 0.1016 (0.004) (reference only)

Chip edge to bond pad dimensions are shown to center of Bond pads.

Chip size tolerance: +/- 0.0508 (0.002)

RF Ground through Backside

Bond Pad #1	(RF Input)	0.100 × 0.200	(0.004 × 0.008)
Bond Pad #2	(Vref)	0.100 × 0.100	(0.004 × 0.004)
Bond Pad #3	(Vd3)	0.100 × 0.100	(0.004 × 0.004)
Bond Pad #4	(Vd4)	0.200 × 0.125	(0.008 × 0.005)
Bond Pad #5	(RF Output)	0.100 × 0.200	(0.004 × 0.008)
Bond Pad #6	(Vdet)	0.100 × 0.100	(0.004 × 0.004)
Bond Pad #7	(Vg4)	0.100 × 0.100	(0.004 × 0.004)
Bond Pad #8	(Vg3)	0.100 × 0.100	(0.004 × 0.004)

Power Detector

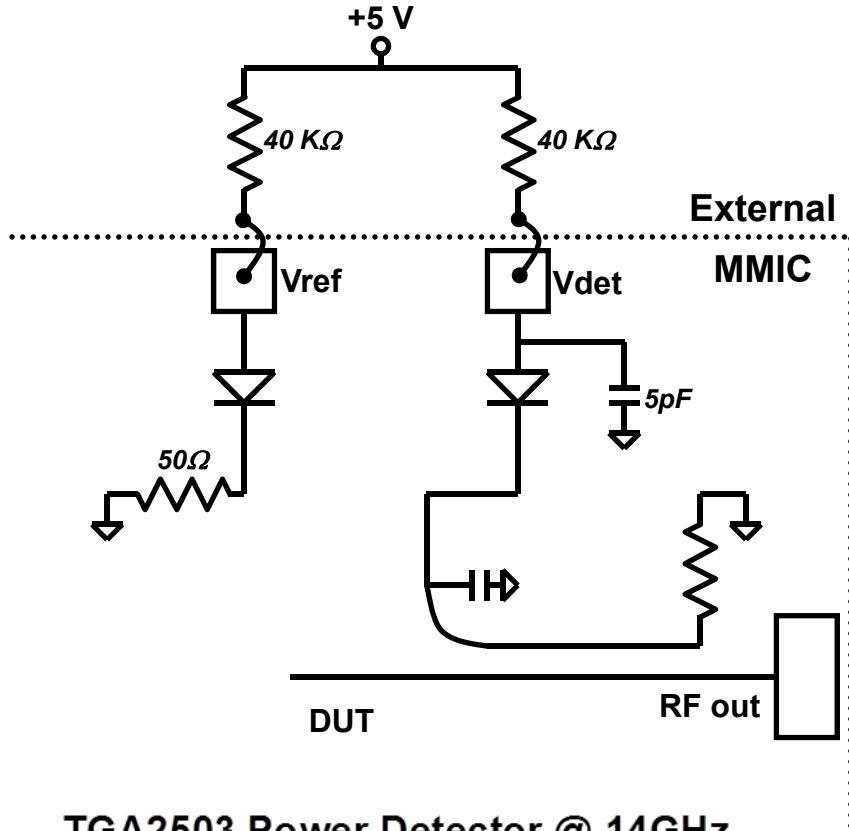

TGA2503 Power Detector @ 14GHz

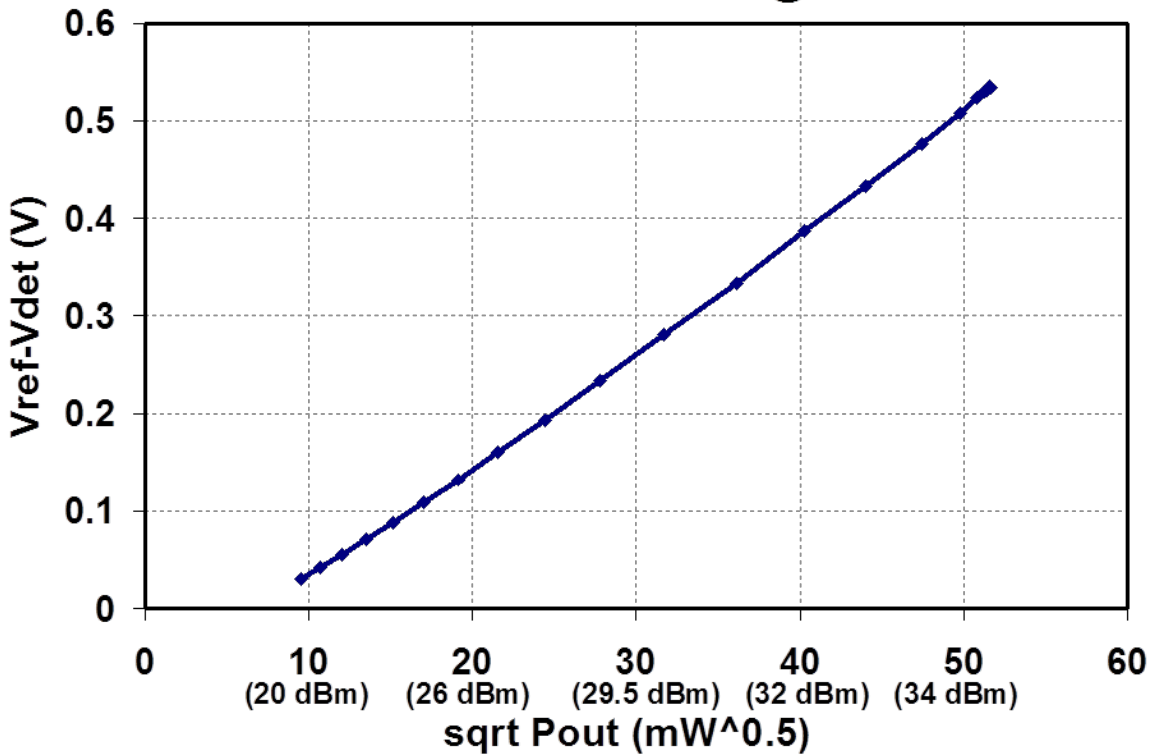

Chip Assembly & Bonding Diagram

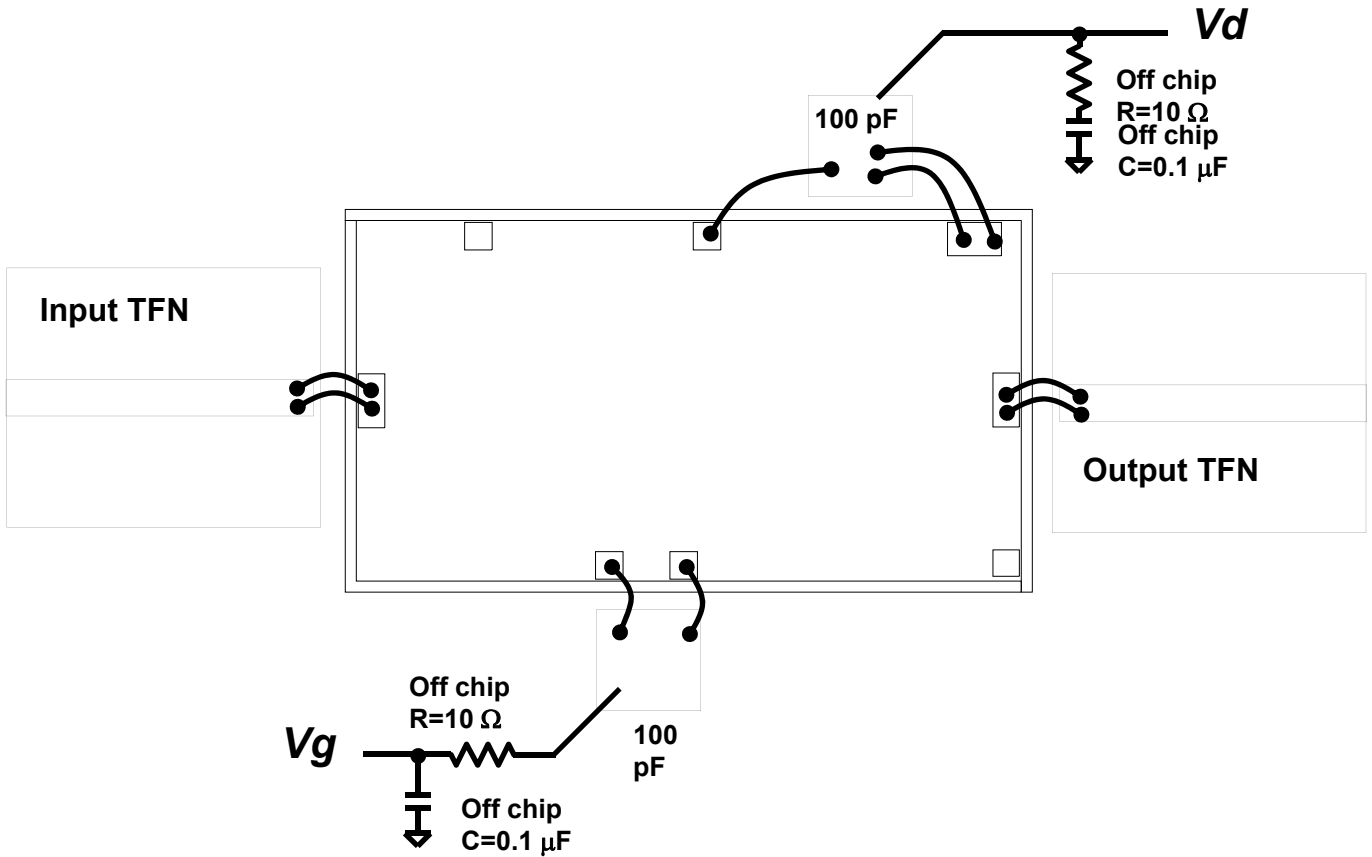

GaAs MMIC devices are susceptible to damage from Electrostatic Discharge. Proper precautions should be observed during handling, assembly and test.

Assembly Process Notes

Reflow process assembly notes:

- Use AuSn (80/20) solder with limited exposure to temperatures at or above 300 °C. (30 seconds maximum)
- An alloy station or conveyor furnace with reducing atmosphere should be used.
- No fluxes should be utilized.
- Coefficient of thermal expansion matching is critical for long-term reliability.
- Devices must be stored in a dry nitrogen atmosphere.

Component placement and adhesive attachment assembly notes:

- Vacuum pencils and/or vacuum collets are the preferred method of pick up.
- Air bridges must be avoided during placement.
- The force impact is critical during auto placement.
- Organic attachment can be used in low-power applications.
- Curing should be done in a convection oven; proper exhaust is a safety concern.
- Microwave or radiant curing should not be used because of differential heating.
- Coefficient of thermal expansion matching is critical.

Interconnect process assembly notes:

- Thermosonic ball bonding is the preferred interconnect technique.
- Force, time, and ultrasonics are critical parameters.
- Aluminum wire should not be used.
- Discrete FET devices with small pad sizes should be bonded with 0.0007-inch wire.
- Maximum stage temperature is 200 °C.

Ordering Information

Part	Package Style
TGA2503	GaAs MMIC Die

GaAs MMIC devices are susceptible to damage from Electrostatic Discharge. Proper precautions should be observed during handling, assembly and test.