

200KHz, 1.5A PWM Buck DC/DC Converter

❖ GENERAL DESCRIPTION

The AX3020 series are monolithic IC designed for a step-down DC/DC converter, and own the ability of driving a 1.5A load without additional transistor. It saves board space. The external shutdown function can be controlled by logic level and then come into standby mode. The internal compensation makes feedback control having good line and load regulation without external design. Regarding protected function, thermal shutdown is to prevent over temperature operating from damage, and current limit is against over current operating of the output switch. If current limit function occurs and V_{FB} is down below 0.5V, the switching frequency will be reduced.

The AX3020 series operates at a switching frequency of 200KHz thus allow smaller sized filter components than what would be needed with lower frequency switching regulators. Other features include a guaranteed +3% tolerances on output voltage under specified input voltage and output load conditions, the chips are available in a standard 8-lead SOP package.

❖ FEATURES

- Output voltage: adjustable output version.
- Adjustable version output voltage range: 0.75V to 22V+3%.
- 200KHz fixed switching frequency.
- Voltage mode non-synchronous PWM control.
- Thermal-shutdown and current-limit protection.
- ON/OFF shutdown control input.
- Short Circuit Protect (SCP).
- Operating voltage can be up to 24V.
- Output load current: 1.5A.
- SOP-8L Pb-Free packages.
- Low power standby mode.
- Built-in switching transistor on chip.

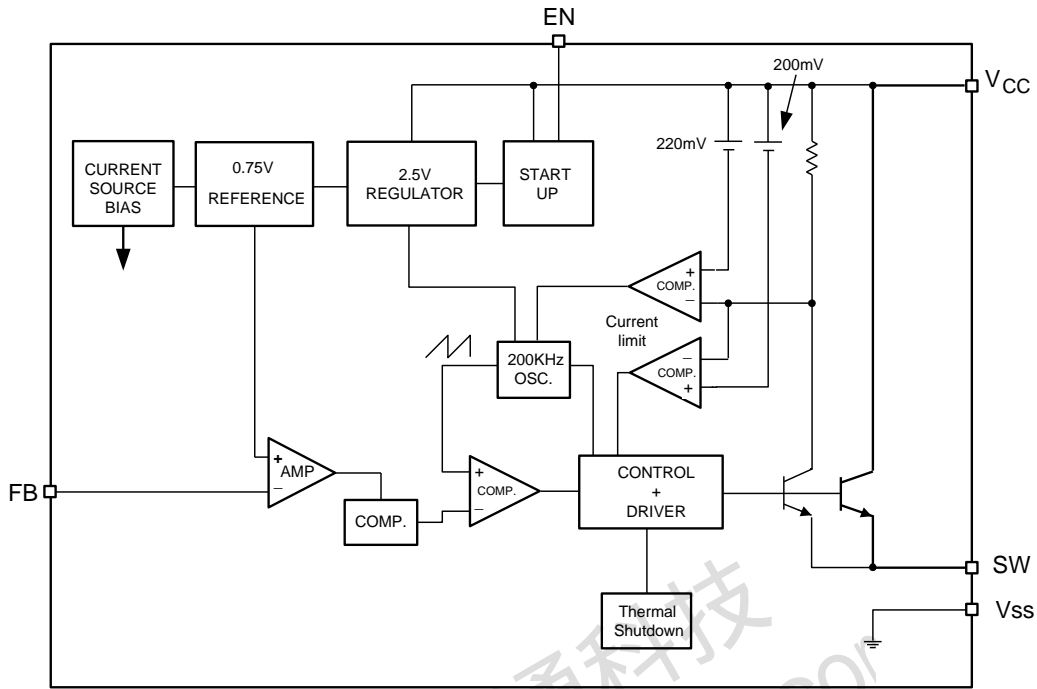
❖ BLOCK DIAGRAM

❖ PIN ASSIGNMENT

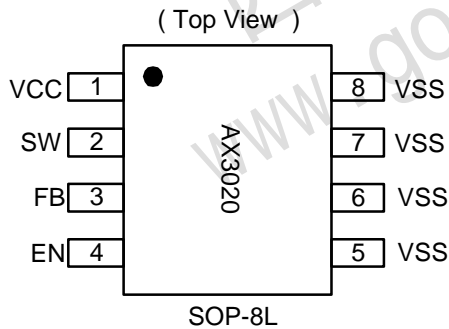
The package of AX3020 is SOP-8L; the pin assignment is given by:



Name	Description
V_{cc}	Operating voltage input
SW	Switching output
FB	Output voltage feedback control
EN	ON/OFF Shutdown HIGH : ON, LOW : OFF
V_{ss}	GND pin

❖ ORDER/MARKING INFORMATION

Order Information	Top Marking
<p>AX3020 X X</p> <p>Package Type Packing S: SOP-8L Blank : Tube A : Taping</p>	<p>Logo ← AX 3 0 2 0 → Part number YY WW X → ID code: internal WW: 01~52 Year: 10=2010 11=2011</p>

❖ ABSOLUTE MAXIMUM RATINGS

Characteristics	Symbol	Rating	Unit
Maximum Supply Voltage	V_{CC}	+26	V
ON/OFF Pin Input Voltage	V_{EN}	-0.3 to V_{CC}	V
Feedback Pin Voltage	V_{FB}	-0.3 to 12	V
Output Voltage to Ground	V_{OUT}	-0.8	V
Power Dissipation Internally limited	PD	$(T_J - T_A) / \theta_{JA}$	W
Storage Temperature Range	T_{ST}	-65 to +150	°C
Operating Junction Temperature Range	T_J	-20 to +125	°C
Operating Supply Voltage	V_{OP}	+4.5 to +24	V
Thermal Resistance from Junction to case	θ_{JC}	20	°C/W
Thermal Resistance from Junction to ambient	θ_{JA}	55	°C/W

Note: θ_{JA} is measured with the PCB copper area(need connect to V_{SS} pins) of approximately 1.5 in² (Multi-layer).

❖ ELECTRICAL CHARACTERISTICS

(Unless otherwise specified, $T_A=25^\circ\text{C}$, $V_{CC}=12\text{V}$, $V_{OUT}=3.3\text{V}$, $I_{OUT} = 0.2\text{A}$)

Characteristics	Symbol	Conditions	Min	Typ	Max	Units
Feedback Voltage	V_{FB}	$I_{OUT}=0.2\text{A}$	0.728	0.750	0.773	V
Quiescent Current	I_Q	$V_{FB}=1.2\text{V}$ force driver off	-	4	8	mA
Feedback bias current	I_{FB}	$I_{OUT}=0.1\text{A}$	-	-10	-50	nA
Shutdown supply Current	I_{SD}	$V_{EN}=0\text{V}$	-	2	10	uA
Oscillator frequency	F_{OSC}		140	200	260	KHz
Oscillator frequency of short circuit protect	F_{SCP}	When $V_{FB}<0.5\text{V}$	-	80	-	KHz
Max. Duty Cycle (ON)	DC	$V_{FB}=1.2\text{V}$ force driver off	-	0	-	%
Min. Duty Cycle (OFF)		$V_{FB}=0\text{V}$ force driver on	-	100	-	
Current limit	I_{CL}	Peak current, No outside circuit $V_{FB}=0\text{V}$ force driver on	1.8	-	-	A
Saturation voltage	V_{SAT}	$I_{OUT}=1.5\text{A}$, No outside circuit $V_{FB}=0\text{V}$ force driver on	-	1.2	1.5	V
SW pin leakage current SW pin=0V	I_{SWL}	No outside circuit $V_{FB}=1.0\text{V}$ force driver off	-	-	-200	uA
SW pin leakage current SW pin=-0.8V		$V_{CC}=24\text{V}$ force driver off	-	-5	-	mA
EN pin logic input threshold voltage	V_{IH}	High (regulator ON)	-	1.2	2.0	V
	V_{IL}	Low (regulator OFF)	0.5		-	
EN pin logic input current	I_H	$V_{EN}=2.5\text{V}$ (ON)	-	20	-	uA
EN pin input current	I_L	$V_{EN}=0.3\text{V}$ (OFF)	-	-5	-	
Thermal shutdown Temp	T_{SD}		-	135	-	°C

❖ APPLICATION CIRCUIT

(1) Adjustable Output Voltage Version

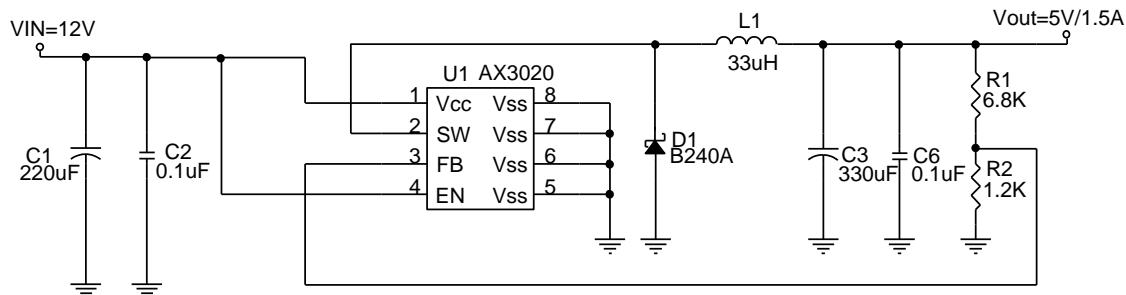

(2) EN PIN With Delayed Startup

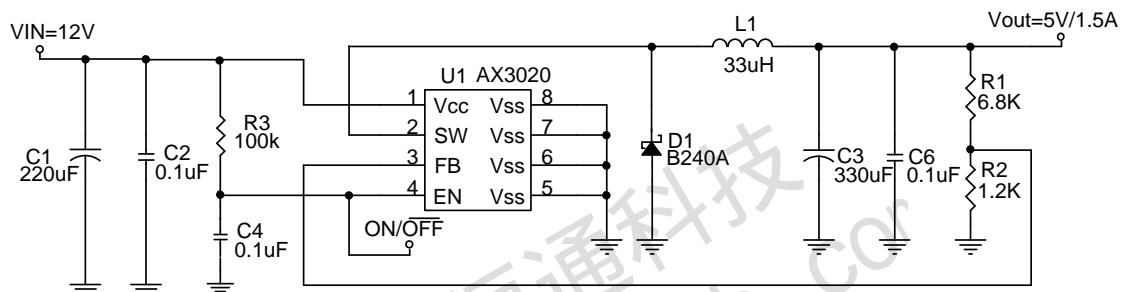

$$V_{OUT} = V_{FB} \times \left(1 + \frac{R1}{R2}\right), V_{FB} = 0.75V, R2 = 0.75K \sim 4K$$

Table 1 Resistor select for output voltage setting

V _{OUT}	R2	R1
5V	1.2K	6.8K
3.3V	2K	6.8K
2.5V	2K	4.7K
1.8V	2K	3K
1.5V	2K	2K
1.3V	2K	1.5K
1.2V	2K	1.2K

L1 recommend value (V _{IN} =12V ,I _{OUT} =1.5A,)				
V _{OUT}	1.8 V	2.5V	3.3V	5V
L1 Value	22uH	22uH	33uH	33uH

❖ FUNCTION DESCRIPTIONS

Pin Functions

V_{CC}

This is the positive input supply for the IC switching regulator. A suitable input bypass capacitor must be presented at this pin to minimize voltage transients and to supply the switching currents needed by the regulator.

V_{SS} Circuit ground.

SW

Internal switch. The voltage at this pin switches between $(+V_{CC} - V_{SAT})$ and approximately $-0.5V$, with a duty cycle of approximately V_{OUT} / V_{CC} . To minimize coupling to sensitive circuitry, the PC board copper area connected to this pin should be minimized.

Feedback

Senses the regulated output voltage to complete the feedback loop.

EN

Allows the switching regulator circuit to be shutdown using logic level signals thus dropping the total input supply current to approximately 10uA. Pulling this pin below a threshold voltage of approximately 0.5V shuts the regulator down, and pulling this pin above 2.0V (up to a maximum of V_{CC}) turns the regulator on.

Thermal Considerations

The SOP-8L package needs a heat sink under most conditions. The size of the heat sink depends on the input voltage, the output voltage, the load current and the ambient temperature. The AX3020 junction temperature rises above ambient temperature for a 1.5A load and different input and output voltages.

For the best thermal performance, wide copper traces and generous amounts of PCB copper (need connect to the V_{SS} pins) should be used in the board layout, (One exception is the SW pin, which should not have large areas of copper.) Large areas of copper provide the best transfer of heat (lower thermal resistance) to the surrounding air, and moving air lowers the thermal resistance even further.

❖ TYPICAL CHARACTERISTICS

VFB VS VIN

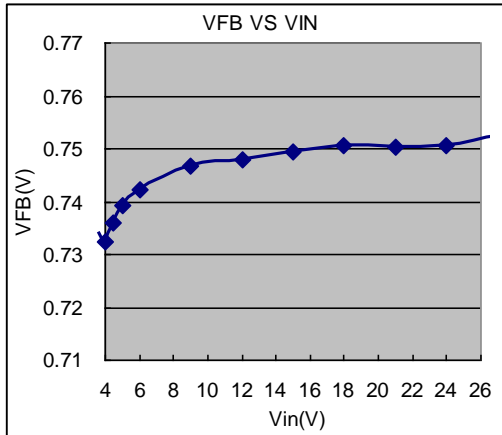

ICCQ VS VIN

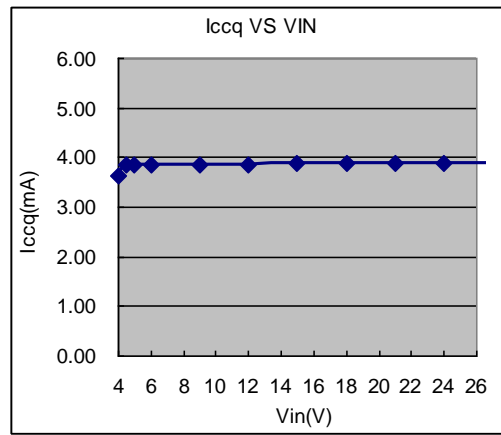

FOSC VS VIN

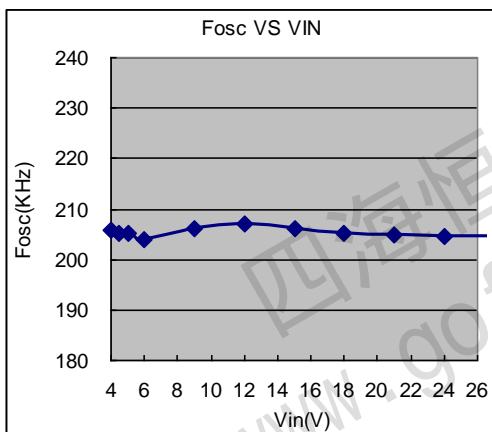

FOSC VS TEMPERATURE

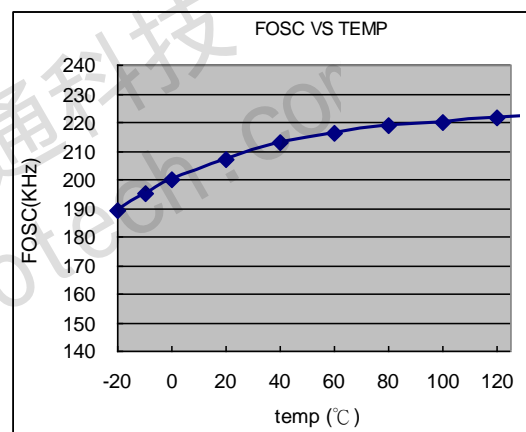

VFB VS TEMPERATURE

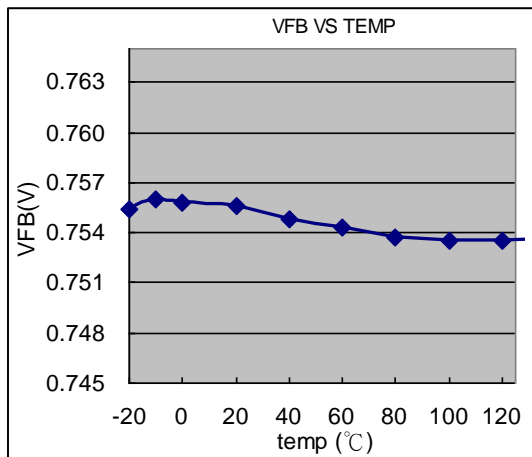

ICCQ VS TEMPERATURE

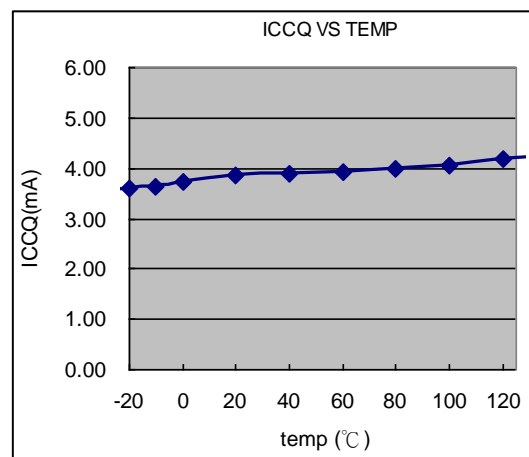

❖ TYPICAL CHARACTERISTICS (CONTINUES)

Output Ripple
($V_{IN}=12V, V_{OUT}=3.3V, I_{OUT}=1.5A$)

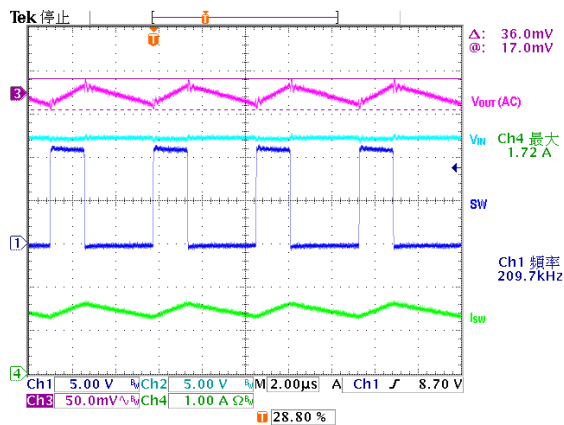

Power on test wave
($V_{IN}=12V, V_{OUT}=3.3V, I_{OUT}=1.5A$)

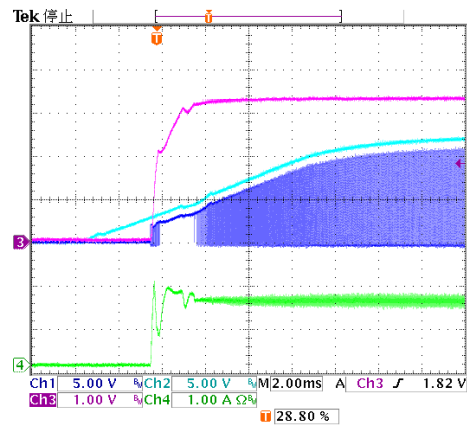

Load Transient Response
($V_{IN}=12V, V_{OUT}=3.3V, I_{OUT}=0.1\sim 1.5A$)

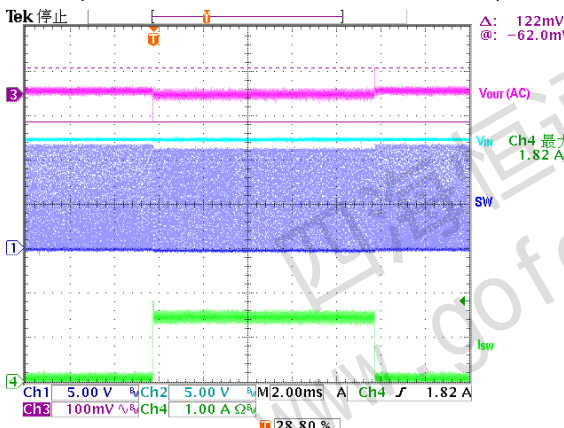

EN PIN on test wave
($V_{IN}=12V, V_{OUT}=3.3V, I_{OUT}=1.5A$)

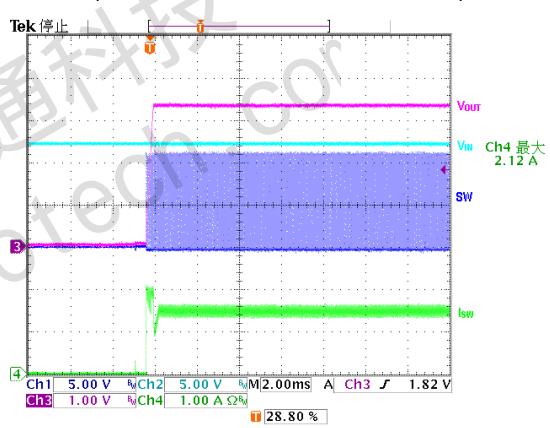

Efficiency
($V_{IN}=12V, V_{OUT}=5V$)

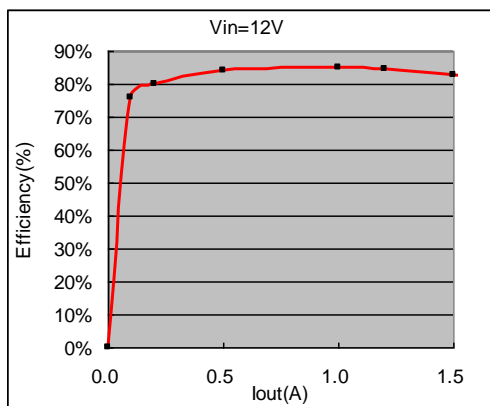

Efficiency
($V_{IN}=12V$)

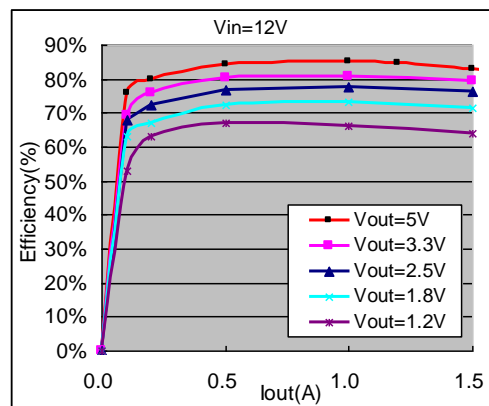

❖ PACKAGE OUTLINES

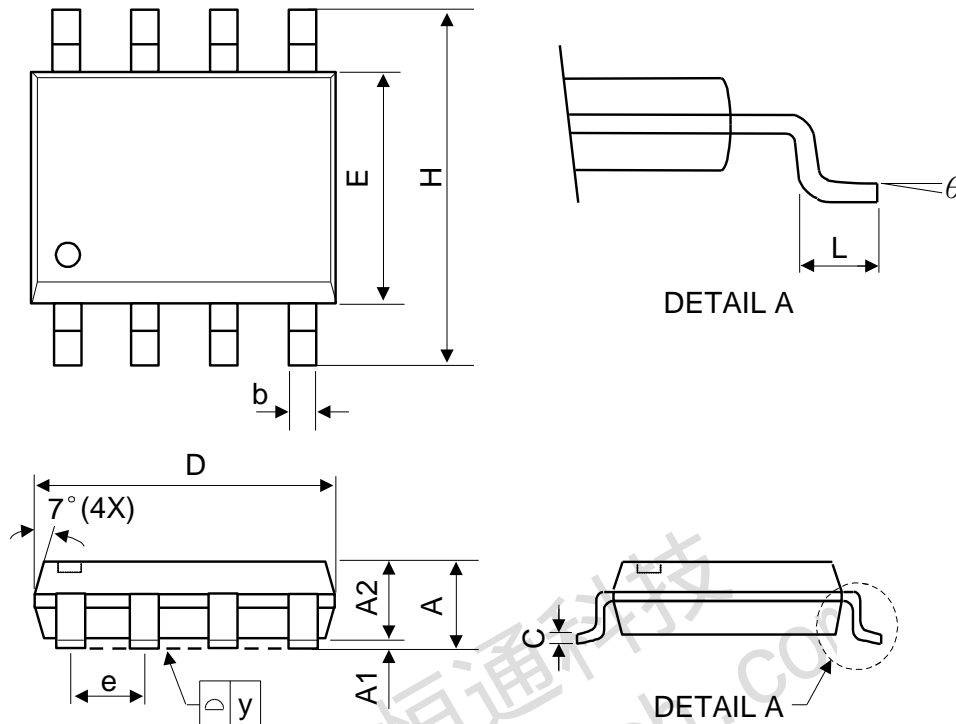

Symbol	Dimensions in Millimeters			Dimensions in Inches		
	Min.	Nom.	Max.	Min.	Nom.	Max.
A	-	-	1.75	-	-	0.069
A1	0.1	-	0.25	0.04	-	0.1
A2	1.25	-	-	0.049	-	-
C	0.1	0.2	0.25	0.0075	0.008	0.01
D	4.7	4.9	5.1	0.185	0.193	0.2
E	3.7	3.9	4.1	0.146	0.154	0.161
H	5.8	6	6.2	0.228	0.236	0.244
L	0.4	-	1.27	0.015	-	0.05
b	0.31	0.41	0.51	0.012	0.016	0.02
e	1.27 BSC			0.050 BSC		
y	-	-	0.1	-	-	0.004
θ	0°	-	8°	0°	-	8°

Mold flash shall not exceed 0.25mm per side

JEDEC outline: MS-012 AA