



Low-Power BiCMOS Current-Mode PWM

FEATURES

- 100µA Typical Starting Supply Current
- 500µA Typical Operating Supply Current
- Operation to 1MHz
- Internal Soft Start
- Internal Fault Soft Start
- Internal Leading-Edge Blanking of the Current Sense Signal
- 1 Amp Totem-Pole Output
- 70ns Typical Response from Current-Sense to Gate Drive Output
- 1.5% Tolerance Voltage Reference
- Same Pinout as UC3842 and UC3842A

DESCRIPTION

The UCC1800/1/2/3/4/5 family of high-speed, low-power integrated circuits contain all of the control and drive components required for off-line and DC-to-DC fixed frequency current-mode switching power supplies with minimal parts count.

These devices have the same pin configuration as the UC1842/3/4/5 family, and also offer the added features of internal full-cycle soft start and internal leading-edge blanking of the current-sense input.

The UCC1800/1/2/3/4/5 family offers a variety of package options, temperature range options, choice of maximum duty cycle, and choice of critical voltage levels. Lower reference parts such as the UCC1803 and UCC1805 fit best into battery operated systems, while the higher reference and the higher UVLO hysteresis of the UCC1802 and UCC1804 make these ideal choices for use in off-line power supplies.

The UCC180x series is specified for operation from -55°C to +125°C, the UCC280x series is specified for operation from -40°C to +85°C, and the UCC380x series is specified for operation from 0°C to +70°C.

ORDERING INFORMATION

| Part Number | Maximum Duty Cycle | Reference Voltage | Turn-On Threshold | Turn-Off Threshold |
|-------------|--------------------|-------------------|-------------------|--------------------|
| UCCx800 | 100% | 5V | 7.2V | 6.9V |
| UCCx801 | 50% | 5V | 9.4V | 7.4V |
| UCCx802 | 100% | 5V | 12.5V | 8.3V |
| UCCx803 | 100% | 4V | 4.1V | 3.6V |
| UCCx804 | 50% | 5V | 12.5V | 8.3V |
| UCCx805 | 50% | 4V | 4.1V | 3.6V |

BLOCK DIAGRAM

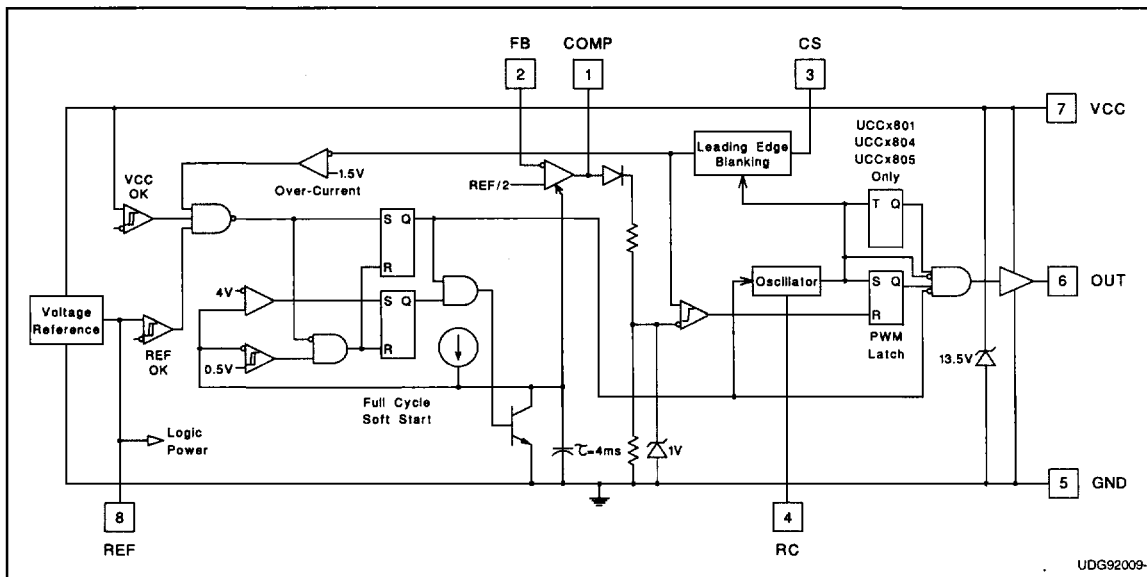

GENERAL POWER SUPPLY

ABSOLUTE MAXIMUM RATINGS (Note 1)

| | |
|---|-----------------|
| VCC Voltage (Note 2)..... | 12.0V |
| VCC Current | 30.0mA |
| OUT Current | ±1.0A |
| OUT Energy (Capacitive Load) | 20.0µJ |
| Analog Inputs (FB, CS)..... | -0.3V to 6.3V |
| Power Dissipation at Ta < +25°C (N or J Package)..... | 1.0W |
| Power Dissipation at Ta < +25°C (D Package)..... | 0.65W |
| Storage Temperature Range..... | -65°C to +150°C |
| Lead Temperature (Soldering, 10 Seconds)..... | +300°C |

Note 1: All voltages are with respect to GND. All currents are positive into the specified terminal. Consult *Unitrode Integrated Circuits databook* for information regarding thermal specifications and limitations of packages.

Note 2: In normal operation VCC is powered through a current limiting resistor. Absolute maximum of 12V applies when VCC is driven from a low impedance source such that ICC does not exceed 30mA.

CONNECTION DIAGRAM

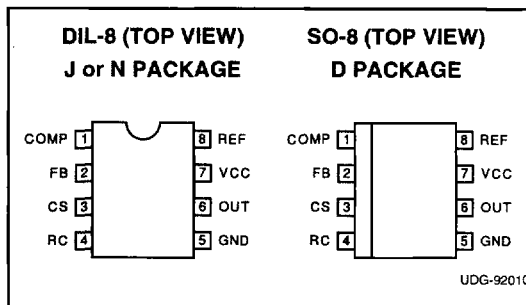

ELECTRICAL CHARACTERISTICS Unless otherwise stated, these specifications apply for -55°C ≤ Ta ≤ +125°C for UCC180x; -40°C ≤ Ta ≤ +85°C for UCC280x; 0°C ≤ Ta ≤ +70°C for UCC380x; VCC=10V (Note 3); RT=100k from REF to RC; CT=330pF from RC to GND; 0.1µF capacitor from VCC to GND; 0.1µF capacitor from VREF to GND. Ta=Tj.

| PARAMETER | TEST CONDITIONS | UCC180X UCC280X | | | UCC380X | | | UNITS |
|--------------------------------|-------------------------------------|--------------------|------|-------|---------|------|-------|-------|
| | | MIN | TYP | MAX | MIN | TYP | MAX | |
| Reference Section | | | | | | | | |
| Output Voltage | Tj=+25°C, I=0.2mA, UCCx800/1/2/4 | 4.925 | 5.00 | 5.075 | 4.925 | 5.00 | 5.075 | V |
| | Tj=+25°C, I=0.2mA, UCCx803/5 | 3.94 | 4.00 | 4.06 | 3.94 | 4.00 | 4.06 | |
| Load Regulation | 0.2mA < I < 5mA | | 10 | 30 | | 10 | 25 | mV |
| Total Variation | UCCx800/1/2/4 (Note 7) | 4.88 | 5.00 | 5.10 | 4.88 | 5.00 | 5.10 | V |
| | UCCx803/5 (Note 7) | 3.90 | 4.00 | 4.08 | 3.90 | 4.00 | 4.08 | V |
| Output Noise Voltage | 10Hz ≤ f ≤ 10kHz, Tj=+25°C (Note 9) | | 70 | | | 70 | | µV |
| Long Term Stability | Ta=+125°C, 1000 Hours (Note 9) | | 5 | | | 5 | | mV |
| Output Short Circuit | | -5 | | -35 | -5 | | -35 | mA |
| Oscillator Section | | | | | | | | |
| Oscillator Frequency | UCCx800/1/2/4 (Note 4) | 40 | 46 | 52 | 40 | 46 | 52 | kHz |
| | UCCx803/5 (Note 4) | 26 | 31 | 36 | 26 | 31 | 36 | |
| Temperature Stability | (Note 9) | | 2.5 | | | 2.5 | | % |
| Amplitude peak-to-peak | | 2.25 | 2.40 | 2.55 | 2.25 | 2.40 | 2.55 | V |
| Oscillator Peak Voltage | | | 2.45 | | | 2.45 | | V |
| Error Amplifier Section | | | | | | | | |
| Input Voltage | COMP=2.5V; UCCx800/1/2/4 | 2.44 | 2.50 | 2.56 | 2.44 | 2.50 | 2.56 | V |
| | COMP=2.0V; UCCx803/5 | 1.95 | 2.0 | 2.05 | 1.95 | 2.0 | 2.05 | |
| Input Bias Current | | -1 | | 1 | -1 | | 1 | µA |
| Open Loop Voltage Gain | | 60 | 80 | | 60 | 80 | | dB |
| COMP Sink Current | FB=2.7V, COMP=1.1V | 0.3 | | 3.5 | 0.4 | | 2.5 | mA |
| COMP Source Current | FB=1.8V, COMP=REF-1.2V | -0.2 | -0.5 | -0.8 | -0.2 | -0.5 | -0.8 | mA |
| Gain Bandwidth Product | (Note 9) | | 2 | | | 2 | | MHz |

ELECTRICAL CHARACTERISTICS (cont.) Unless otherwise stated, these specifications apply for $-55^{\circ}\leq T_a\leq+125^{\circ}\text{C}$ for UCC180x; $-40^{\circ}\leq T_a\leq+85^{\circ}\text{C}$ for UCC280x; $0^{\circ}\text{C}\leq T_a\leq+70^{\circ}\text{C}$ for UCC380x; $V_{CC}=10\text{V}$ (Note 3); $R_T=100\text{k}$ from REF to RC; $C_T=330\text{pF}$ from RC to GND; $0.1\mu\text{F}$ capacitor from VCC to GND; $0.1\mu\text{F}$ capacitor from VREF to GND. $T_a=T_j$.

| PARAMETER | TEST CONDITIONS | UCC180X UCC280X | | | UCC380X | | | UNITS |
|--|-----------------------------------|--------------------|------|------|---------|------|------|-------|
| | | MIN | TYP | MAX | MIN | TYP | MAX | |
| PWM Section | | | | | | | | |
| Maximum Duty Cycle | UCCx800/2/3 | 97 | 99 | 100 | 97 | 99 | 100 | % |
| | UCCx801/4/5 | 48 | 49 | 50 | 48 | 49 | 50 | |
| Minimum Duty Cycle | COMP=0V | | | 0 | | | 0 | % |
| Current Sense Section | | | | | | | | |
| Gain | (Note 5) | 1.10 | 1.65 | 1.80 | 1.10 | 1.65 | 1.80 | V/V |
| Maximum Input Signal | COMP=5V (Note 6) | 0.9 | 1.0 | 1.1 | 0.9 | 1.0 | 1.1 | V |
| Input Bias Current | | -200 | | 200 | -200 | | 200 | nA |
| CS Blank Time | | 50 | 100 | 150 | 50 | 100 | 150 | ns |
| Over-Current Threshold | | 1.42 | 1.55 | 1.68 | 1.42 | 1.55 | 1.68 | V |
| COMP to CS Offset | CS=0V | 0.45 | 0.90 | 1.35 | 0.45 | 0.90 | 1.35 | V |
| Output Section | | | | | | | | |
| OUT Low Level | I=-20mA, all parts | | 0.1 | 0.4 | | 0.1 | 0.4 | V |
| | I=-200mA, all parts | | 0.35 | 0.90 | | 0.35 | 0.90 | |
| | I=-50mA, VCC=5V, UCCx803/5 | | 0.15 | 0.40 | | 0.15 | 0.40 | |
| | I=-20mA, VCC=0V, all parts | | 0.7 | 1.2 | | 0.7 | 1.2 | |
| OUT High V_{SAT} ($V_{CC}-OUT$) | I=-20mA, all parts | | 0.15 | 0.40 | | 0.15 | 0.40 | V |
| | I=-200mA, all parts | | 1.0 | 1.9 | | 1.0 | 1.9 | |
| | I=-50mA, VCC=5V, UCCx803/5 | | 0.4 | 0.9 | | 0.4 | 0.9 | |
| Rise Time | $C_L=1\text{nF}$ | | 41 | 70 | | 41 | 70 | ns |
| Fall Time | $C_L=1\text{nF}$ | | 44 | 75 | | 44 | 75 | ns |
| Undervoltage Lockout Section | | | | | | | | |
| Start Threshold (Note 8) | UCCx800 | 6.6 | 7.2 | 7.8 | 6.6 | 7.2 | 7.8 | V |
| | UCCx801 | 8.6 | 9.4 | 10.2 | 8.6 | 9.4 | 10.2 | |
| | UCCx802/4 | 11.5 | 12.5 | 13.5 | 11.5 | 12.5 | 13.5 | |
| | UCCx803/5 | 3.7 | 4.1 | 4.5 | 3.7 | 4.1 | 4.5 | |
| Stop Threshold (Note 8) | UCCx1800 | 6.3 | 6.9 | 7.5 | 6.3 | 6.9 | 7.5 | V |
| | UCCx1801 | 6.8 | 7.4 | 8.0 | 6.8 | 7.4 | 8.0 | |
| | UCCx802/4 | 7.6 | 8.3 | 9.0 | 7.6 | 8.3 | 9.0 | |
| | UCCx803/5 | 3.2 | 3.6 | 4.0 | 3.2 | 3.6 | 4.0 | |
| Start to Stop Hysteresis | UCCx800 | 0.12 | 0.3 | 0.48 | 0.12 | 0.3 | 0.48 | V |
| | UCCx801 | 1.6 | 2 | 2.4 | 1.6 | 2 | 2.4 | |
| | UCCx802/4 | 3.5 | 4.2 | 5.1 | 3.5 | 4.2 | 5.1 | |
| | UCCx803/5 | 0.2 | 0.5 | 0.8 | 0.2 | 0.5 | 0.8 | |
| Soft Start Section | | | | | | | | |
| COMP Rise Time | FB=1.8V, Rise from 0.5V to REF-1V | | 4 | | | 4 | | ms |



GENERAL POWER SUPPLY

ELECTRICAL CHARACTERISTICS (cont.) Unless otherwise stated, these specifications apply for $-55^{\circ}\text{C} \leq \text{Ta} \leq +125^{\circ}\text{C}$ for UCC180x; $-40^{\circ}\text{C} \leq \text{Ta} \leq +85^{\circ}\text{C}$ for UCC280x; $0^{\circ}\text{C} \leq \text{Ta} \leq +70^{\circ}\text{C}$ for UCC380x; $\text{VCC}=10\text{V}$ (Note 3); $\text{RT}=100\text{k}$ from REF to RC; $\text{CT}=330\text{pF}$ from RC to GND; $0.1\mu\text{F}$ capacitor from VCC to GND; $0.1\mu\text{F}$ capacitor from VREF to GND. $\text{Ta}=\text{Tj}$.

| PARAMETER | TEST CONDITIONS | UCC180X UCC280X | | | UCC380X | | | UNITS |
|--|-----------------------|--------------------|------|-----|---------|------|-----|-------|
| | | MIN | TYP | MAX | MIN | TYP | MAX | |
| Overall Section | | | | | | | | |
| Start-up Current | VCC < Start Threshold | | 0.1 | 0.2 | | 0.1 | 0.2 | mA |
| Operating Supply Current | FB=0V, CS=0V, RC=0V | | 0.5 | 1.0 | | 0.5 | 1.0 | mA |
| VCC Internal Zener Voltage | ICC=10mA (Note 8) | 12 | 13.5 | 15 | 12 | 13.5 | 15 | V |
| VCC Internal Zener Voltage Minus Start Threshold Voltage | UCCx802/4 | 0.5 | 1.0 | | 0.5 | 1.0 | | V |

Note 3: Adjust VCC above the start threshold before setting at 10V.

Note 4: Oscillator frequency for the UCCx800, UCCx802 and UCCx803 is the output frequency.

Oscillator frequency for the UCCx801, UCCx804 and UCCx805 is twice the output frequency.

Note 5: Gain is defined by: $A = \frac{\Delta V_{\text{COMP}}}{\Delta V_{\text{CS}}} \quad 0 \leq V_{\text{CS}} \leq 0.8\text{V}$.

Note 6: Parameter measured at trip point of latch with Pin 2 at 0V.

Note 7: Total Variation includes temperature stability and load regulation.

Note 8: Start Threshold, Stop Threshold and Zener Shunt Thresholds track one another.

Note 9: Guaranteed by design. Not 100% tested in production.

PIN DESCRIPTIONS

COMP: COMP is the output of the error amplifier and the input of the PWM comparator.

Unlike other devices, the error amplifier in the UCC3800 family is a true, low output-impedance, 2MHz operational amplifier. As such, the COMP terminal can both source and sink current. However, the error amplifier is internally current limited, so that you can command zero duty cycle by externally forcing COMP to GND.

The UCC3800 family features built-in full cycle Soft Start. Soft Start is implemented as a clamp on the maximum COMP voltage.

FB: FB is the inverting input of the error amplifier. For best stability, keep FB lead length as short as possible and FB stray capacitance as small as possible.

CS: CS is the input to the current sense comparators. The UCC3800 family has two different current sense comparators: the PWM comparator and an over-current comparator.

The UCC3800 family contains digital current sense filtering, which disconnects the CS terminal from the current sense comparator during the 100ns interval immediately following the rising edge of the OUT pin. This digital filtering, also called leading-edge blanking, means that in most applications, no analog filtering (RC filter) is required on CS. Compared to an external RC filter technique, the leading-edge blanking provides a smaller effective CS to OUT propagation delay. Note, however, that the minimum non-zero On-Time of the OUT signal is directly affected by

the leading-edge-blanking and the CS to OUT propagation delay.

The over-current comparator is only intended for fault sensing, and exceeding the over-current threshold will cause a soft start cycle.

RC: RC is the oscillator timing pin. For fixed frequency operation, set timing capacitor charging current by connecting a resistor from REF to RC. Set frequency by connecting a timing capacitor from RC to GND. For best performance, keep the timing capacitor lead to GND as short and direct as possible. If possible, use separate ground traces for the timing capacitor and all other functions.

The frequency of oscillation can be estimated with the following equations:

$$\text{UCCx800/1/2/4:} \quad F = \frac{1.5}{R \times C}$$

$$\text{UCCx803, UCCx805:} \quad F = \frac{1.0}{R \times C}$$

where frequency is in Hz, resistance is in ohms, and capacitance is in farads. The recommended range of timing resistors is between 10k and 200k and timing capacitor is 100pF to 1000pF. Never use a timing resistor less than 10k.

GND: GND is reference ground and power ground for all functions on this part.

OUT: OUT is the output of a high-current power driver capable of driving the gate of a power MOSFET with peak

PIN DESCRIPTIONS (cont.)

currents exceeding $\pm 750\text{mA}$. OUT is actively held low when VCC is below the UVLO threshold.

The high-current power driver consists of FET output devices, which can switch all of the way to GND and all of the way to VCC. The output stage also provides a very low impedance to overshoot and undershoot. This means that in many cases, external schottky clamp diodes are not required.

VCC: VCC is the power input connection for this device. In normal operation VCC is powered through a current limiting resistor. Although quiescent VCC current is very low, total supply current will be higher, depending on OUT current. Total VCC current is the sum of quiescent VCC current and the average OUT current. Knowing the operating frequency and the MOSFET gate charge (Qg), average OUT current can be calculated from: $I_{OUT} = Q_g \times F$.

To prevent noise problems, bypass VCC to GND with a ceramic capacitor as close to the VCC pin as possible. An

electrolytic capacitor may also be used in addition to the ceramic capacitor.

REF: REF is the voltage reference for the error amplifier and also for many other functions on the IC. REF is also used as the logic power supply for high speed switching logic on the IC.

When VCC is greater than 1V and less than the UVLO threshold, REF is pulled to ground through a 5k ohm resistor. This means that REF can be used as a logic output indicating power system status. It is important for reference stability that REF is bypassed to GND with a ceramic capacitor as close to the pin as possible. An electrolytic capacitor may also be used in addition to the ceramic capacitor. A minimum of $0.1\mu\text{F}$ ceramic is required. Additional REF bypassing is required for external loads greater than 2.5mA on the reference.



GENERAL POWER SUPPLY

OSCILLATOR

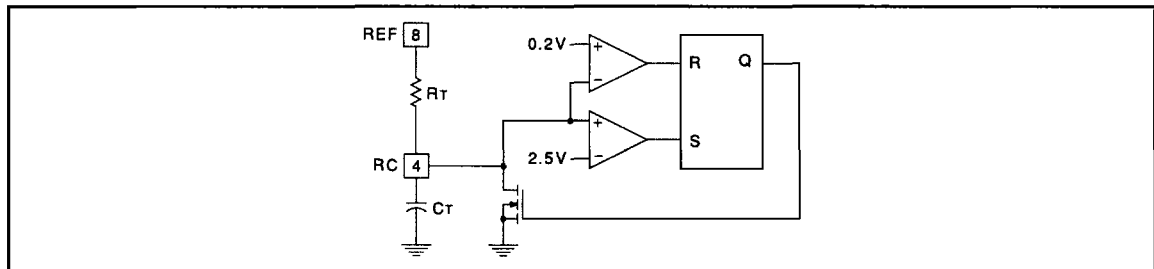

The UCC3800/1/2/3/4/5 oscillator generates a sawtooth waveform on RC. The rise time is set by the time constant of RT and CT. The fall time is set by CT and an internal transistor on-resistance of approximately 125Ω . During the fall time, the output is off and the maximum duty cycle is reduced below 50% or 100% depending on the part number. Larger timing capacitors increase the discharge time and reduce the maximum duty cycle and frequency.

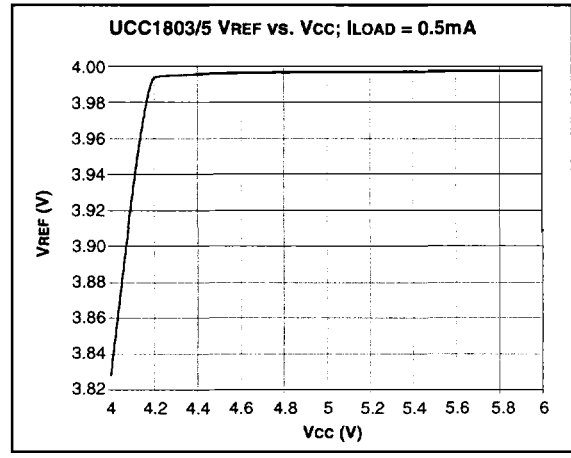
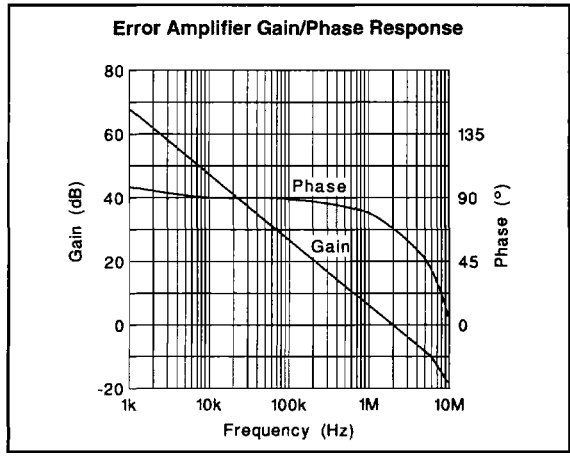

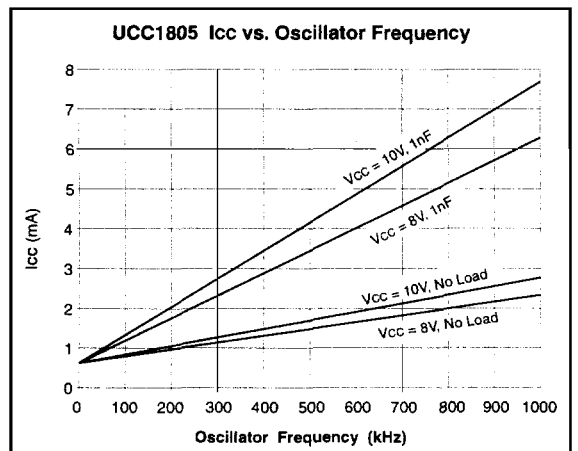
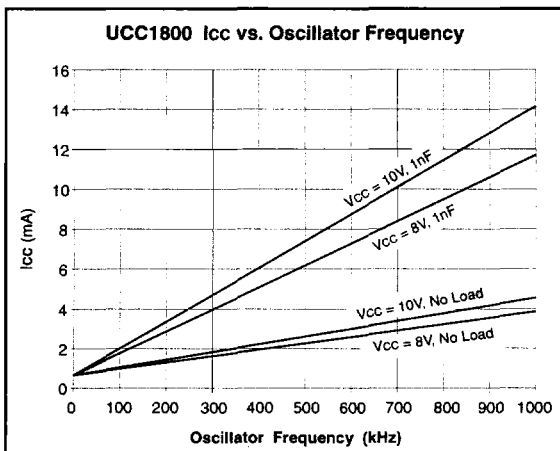
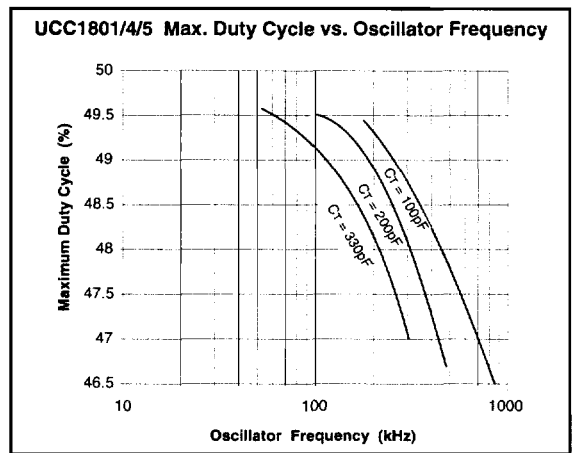
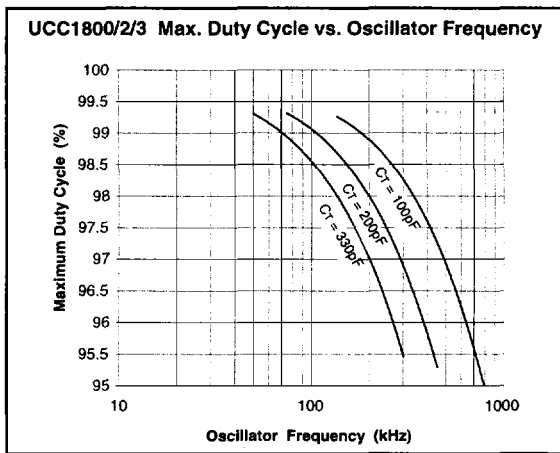
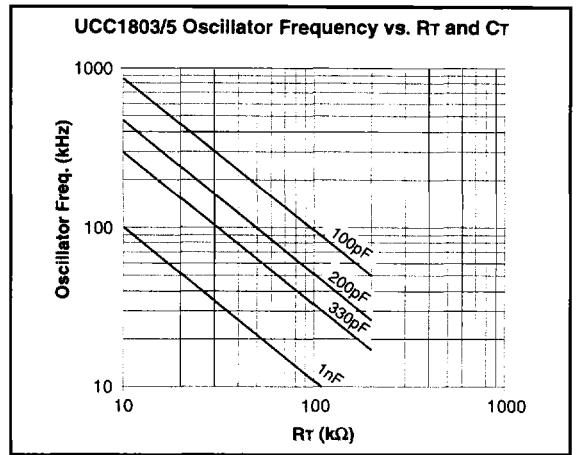
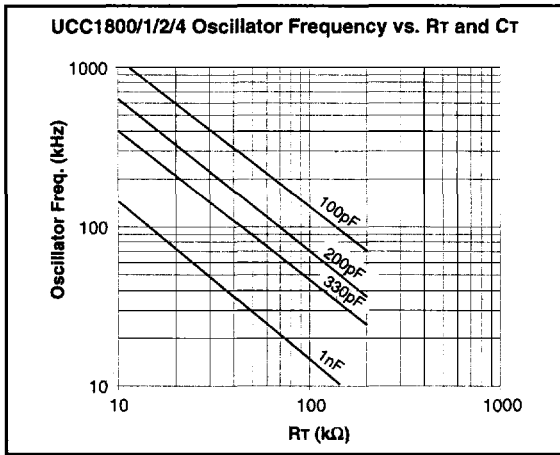

UCC1800/1/2/3/4/5
 UCC2800/1/2/3/4/5
 UCC3800/1/2/3/4/5

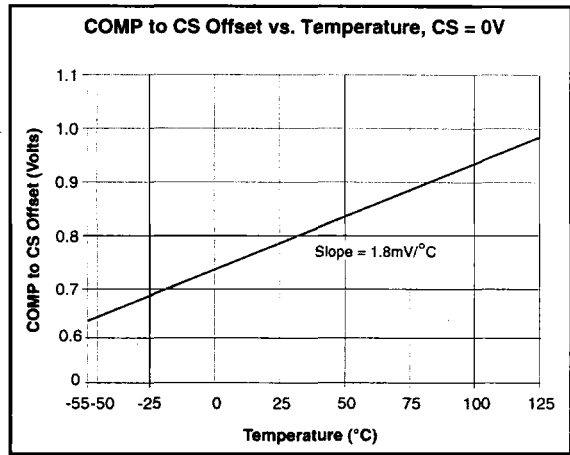
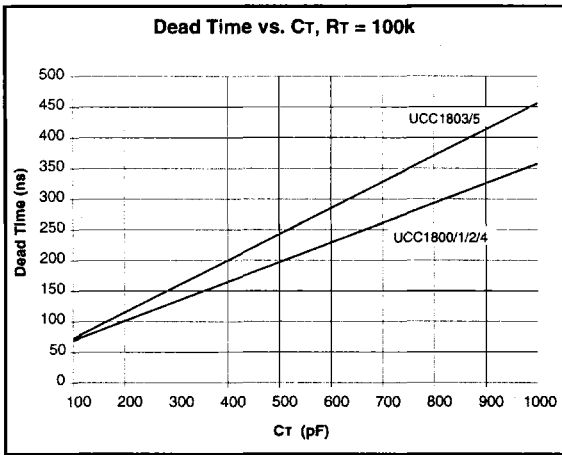

GENERAL POWER SUPPLY