

QUAD SINGLE-SUPPLY OPERATIONAL AMPLIFIER

■ GENERAL DESCRIPTION

The NJM2902 consists of four independent high-gain operational amplifiers that are designed for single-supply operation.

Operation from split power supplies is also possible and the low power supply drain is independent of the magnitude of the power supply voltage.

Used with a dual supply the circuit will operate over a wide range of supply voltages. However, a large amount of crossover distortion may occur with loads to ground. An external current-sinking resistor to $-V_S$ will reduce crossover distortion.

There is no crossover distortion problem in single-supply operation if the load is direct-coupled to ground.

■ PACKAGE OUTLINE

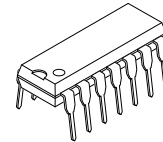

NJM2902N

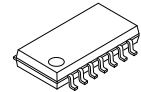

NJM2902M



NJM2902V

■ FEATURES

- Single Supply
- Operating Voltage (+3V~+32V)
- High Output Voltage ($V^+ - 2V$)
- Slew Rate (0.5V/ μ s typ.)
- Low Operating Current (1mA typ.)
- Package Outline DIP14, DMP14, SSOP14
- Bipolar Technology

■ PIN CONFIGURATION

NJM2902N, NJM2902M
NJM2902V

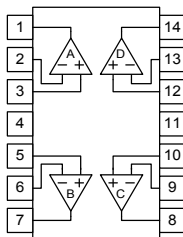

PIN FUNCTION

- | | |
|------------------|-------------|
| 1.A OUTPUT | 8.C OUTPUT |
| 2.A -INPUT | 9.C -INPUT |
| 3.A +INPUT | 10.C +INPUT |
| 4.V ⁺ | 11.V |
| 5.B +INPUT | 12.D +INPUT |
| 6.B -INPUT | 13.D -INPUT |
| 7.B OUTPUT | 14.D OUTPUT |

■ EQUIVALENT CIRCUIT (1/4 Shown)

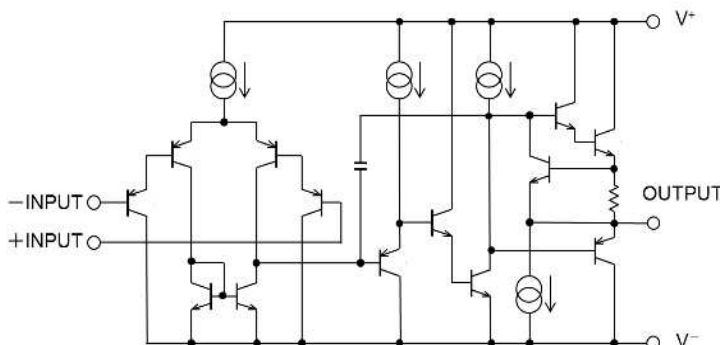

NJM2902

■ ABSOLUTE MAXIMUM RATINGS

(Ta=25°C)

PARAMETER	SYMBOL	RATINGS	UNIT
Supply Voltage	$V^+(V^+V^-)$	32 (or ± 16)	V
Differential Input Voltage	V_{ID}	32	V
Input Voltage	V_{IC}	-0.3~32(Note2)	V
Power Dissipation	P_D	(DIP14) 570 (DMP14) 300 (SSOP14) 300	mW
Operating Temperature Range	T_{opr}	-40~+85	°C
Storage Temperature Range	T_{stg}	-50~+125	°C

(Note1) Continuous short-circuits from output to GND is guaranteed only when $V^+\leq 15V$.

(Note2) For supply voltage less than $32V[\pm 16]$, the absolute maximum input voltage is equal to supply voltage.

■ ELECTRICAL CHARACTERISTICS

(Ta=25°C, $V^+=5V$)

PARAMETER	SYMBOL	TEST CONDITION	MIN.	TYP.	MAX.	UNIT
Input Offset Voltage	V_{IO}	$R_S=0\Omega$	-	2	10	mV
Input Offset Current	I_{IO}	$I_{IN^+}-I_{IN^-}$	-	5	50	nA
Input Bias Current	I_B	I_{IN^+} or I_{IN^-}	-	20	500	nA
Large Signal Voltage Gain	A_V	$R_L>2k\Omega$	-	100	-	V/mV
Maximum Output Voltage Swing	V_{OPP}	$R_L=2k\Omega$	3.5	-	-	V
Input Common Mode Voltage Range	V_{ICM}		0~3.5	-	-	V
Common Mode Rejection Ratio	CMR		-	85	-	dB
Supply Voltage Rejection Ratio	SVR		-	100	-	dB
Output Source Current	I_{SOURCE}	$V_{IN^+}=1V, V_{IN^-}=0V$	20	40	-	mA
Output Sink Current	I_{SINK}	$V_{IN^+}=0V, V_{IN^-}=1V$	8	20	-	mA
Channel Separation	CS	$f=1k\sim 20kHz$, Input Referred	-	120	-	dB
Operating Current	I_{CC}	$R_L=\infty$	-	1	2	mA
Slew Rate	SR	$V^+V^-=\pm 15V$	-	0.5	-	V/ μs
Gain Bandwidth Product	GB	$V^+V^-=\pm 15V$	-	0.5	-	MHz

■ TYPICAL CHARACTERISTICS

Maximum Output Voltage Swing vs. Load Resistance
($V^+=5V$, $T_a=25^\circ C$)

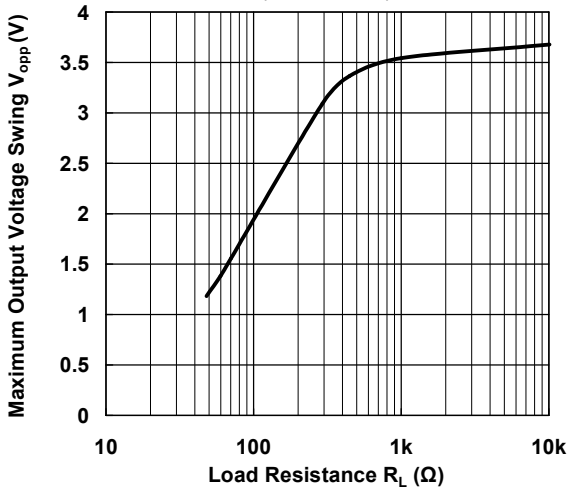

Voltage Gain, Phase vs. Frequency
($V^+V^-=\pm 15V$, $R_L=\infty$, 40dBamp, $T_a=25^\circ C$)

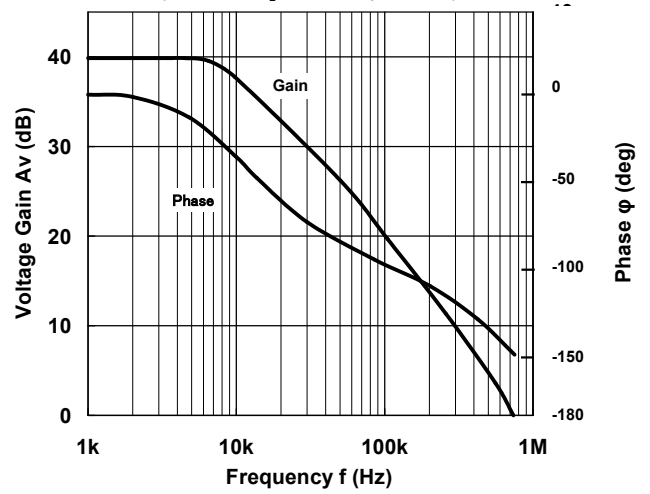

Operating Current vs. Operating Voltage
($T_a=25^\circ C$)

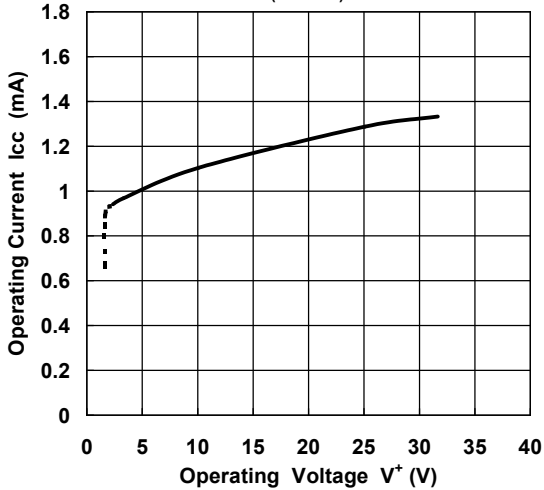

Voltage Gain vs. Operating Voltage
($T_a=25^\circ C$)

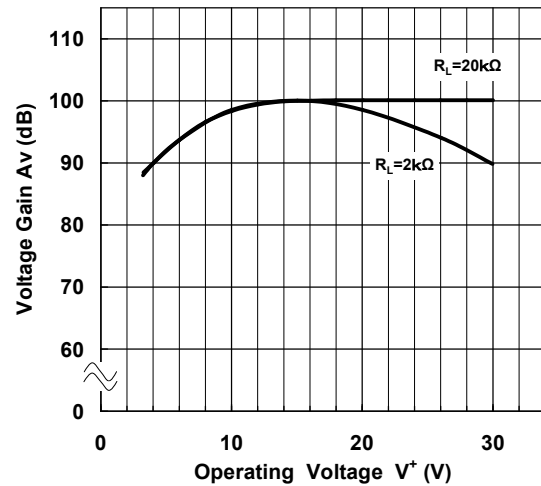

Maximum Output Voltage vs. Operating Voltage
($R_L=2k\Omega$, $T_a=25^\circ C$)

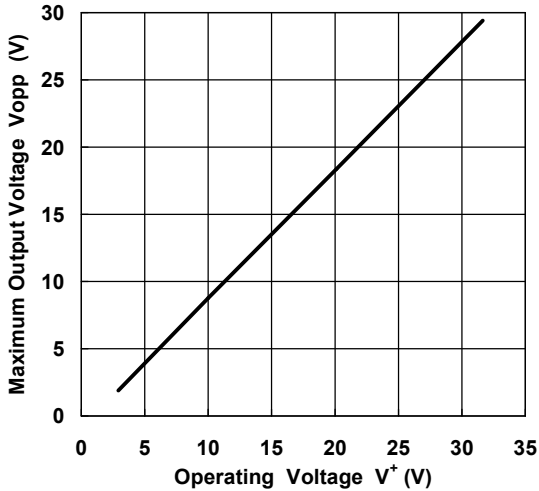

■ TYPICAL CHARACTERISTICS

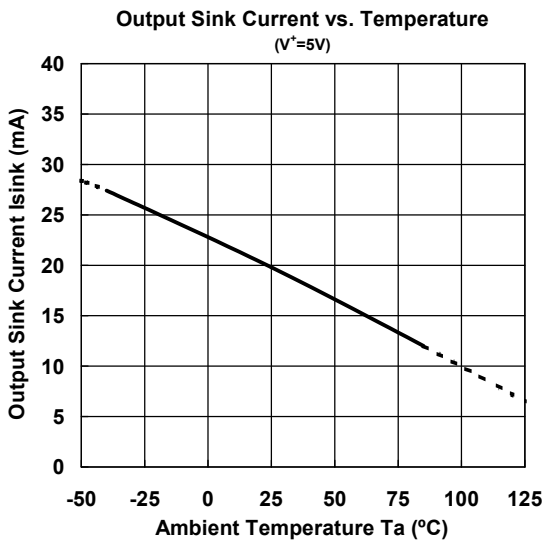
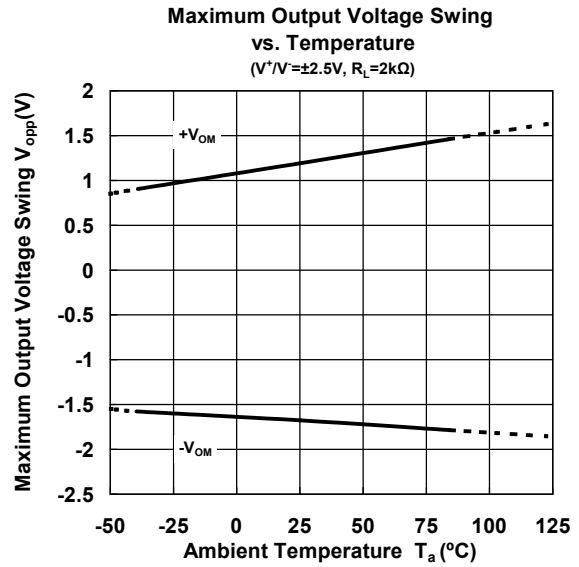
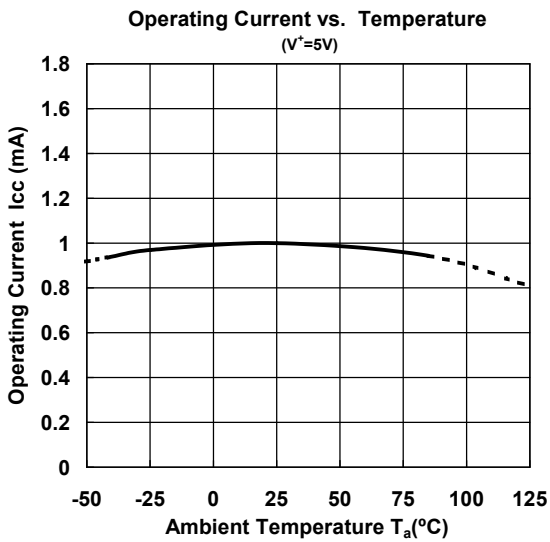
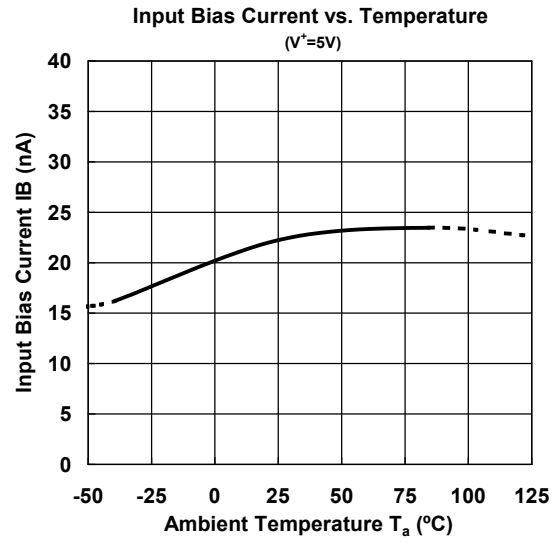
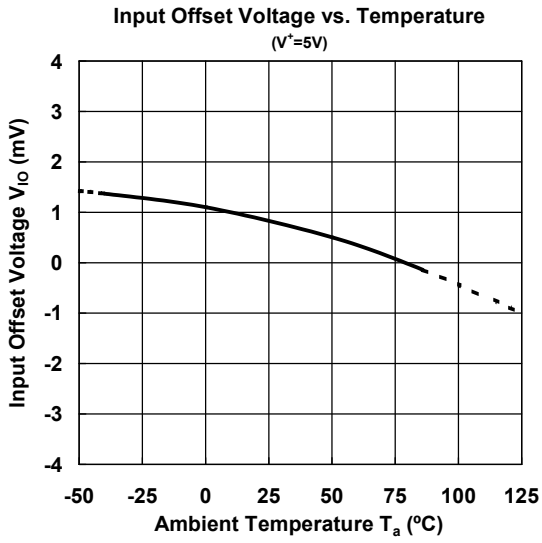

■ TYPICAL CHARACTERISTICS

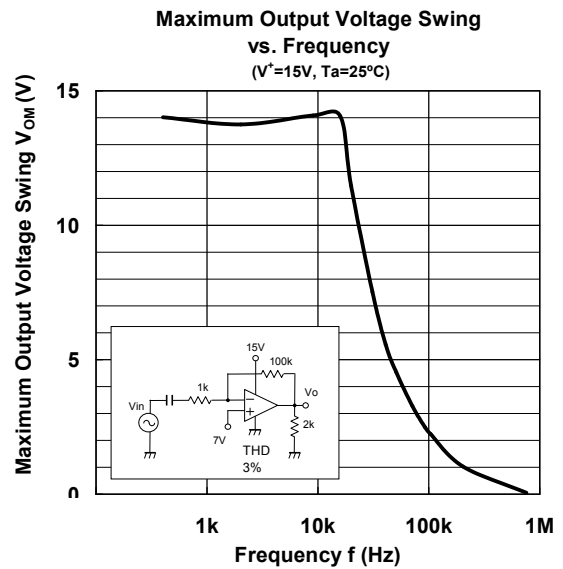
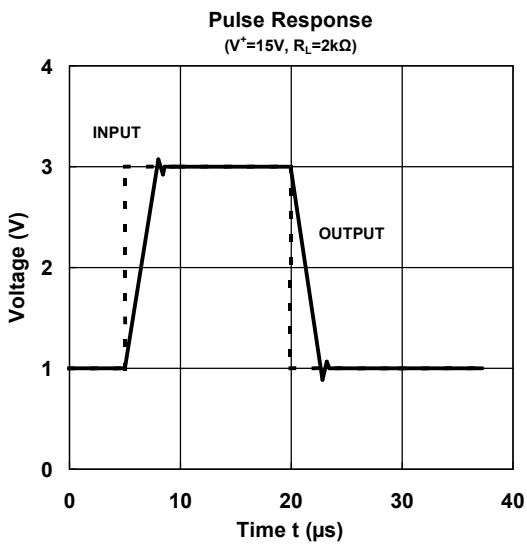
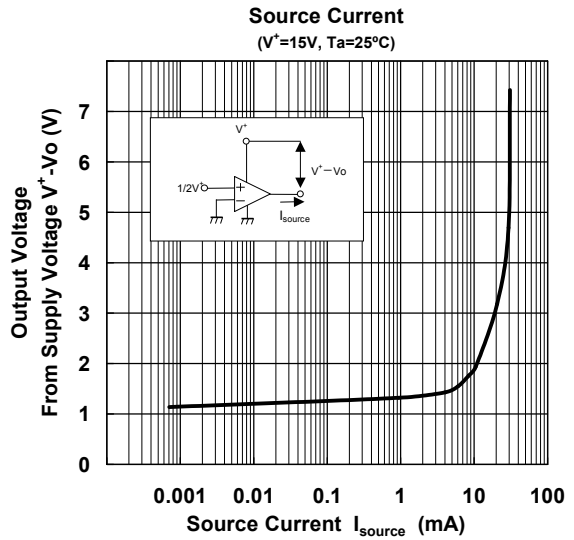
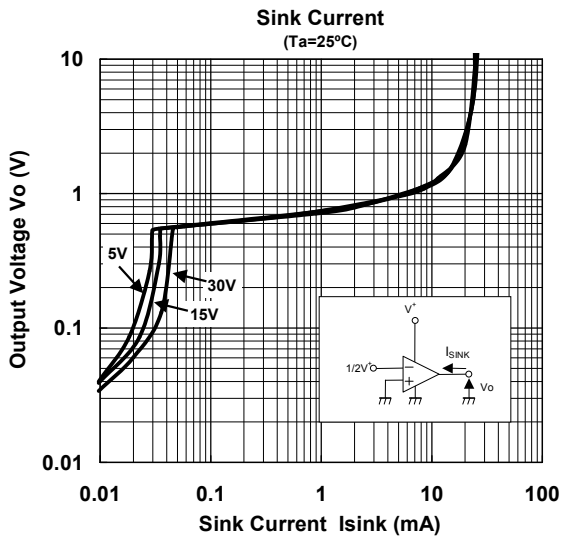

APPLICATION

Improvement of Cross-over Distortion
Equivalent circuit at the output stage

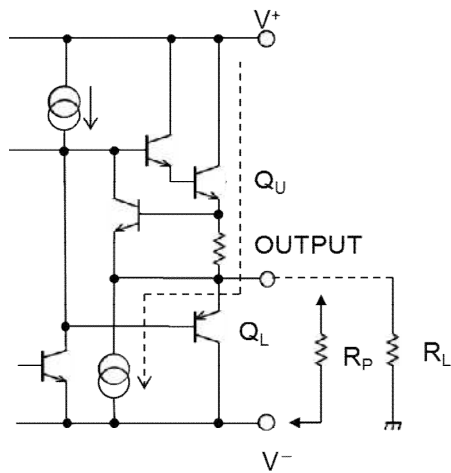

NJM2902, in its static state (No in and output condition) when design, Q_U being biased by constant current (break down beam) yet, Q_L stays OFF.

While using with both power source mode, the cross-over distortion might occur instantly when Q_L ON.

There might be cases when application for amplifier of audio signals, not only distortion but also the apparent frequency bandwidth being narrowed remarkably.

It is adjustable especially when using both power source mode, constantly to use with higher current on Q_U than the load current (including feedback current), and then connect the pull-down resistor R_P at the part between output and V^- pins.

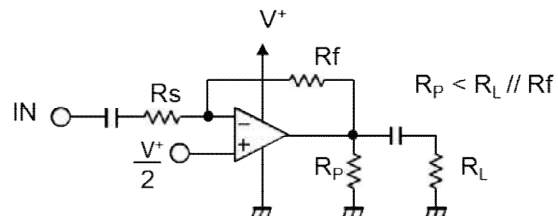
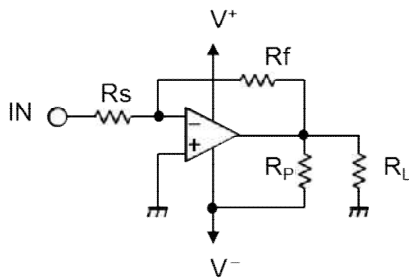

[CAUTION]

The specifications on this databook are only given for information, without any guarantee as regards either mistakes or omissions. The application circuits in this databook are described only to show representative usages of the product and not intended for the guarantee or permission of any right including the industrial rights.