

# Shwo 1W Series

燦

*“Shwo [Shuo] is the English translation for the Chinese word meaning Twinkle and is often used as a description of stars or other bright, celestial objects as seen from Earth. This word is a relevant description for this bright, compact Everlight LED package.”*

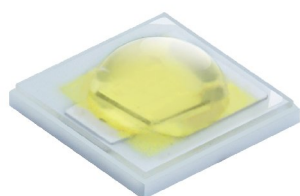

## Introduction

The Shwo series is a surface-mount high-power device featuring high brightness combined with a compact size that is suitable for all kinds of lighting applications such as general illumination, flash, spot, signal, industrial and commercial lighting. The thermal pad of this device is electrically isolated providing convenience in thermal and electrical design. The Shwo series is one of the most promising devices in Everlight's high power product offering and is ready to face the challenges of today's Solid-State Lighting requirements.

## Features

- ◆ LM-80 Certified
- ◆ Small package with high efficiency
- ◆ ESD protection up to 8KV
- ◆ Soldering method: SMT
- ◆ Binning Parameters: Brightness, Forward Voltage ,Wavelength and Chromaticity
- ◆ Moisture Sensitivity Level: 1
- ◆ RoHS compliant
- ◆ Matches ANSI binning

## Applications

- ◆ General Lighting
- ◆ Decorative and Entertainment Lighting
- ◆ Signal and Symbol Luminaries for orientation marker lights (e.g. steps, exit ways, etc.)
- ◆ Exterior and Interior Automotive Illumination
- ◆ Agriculture Lighting

## Table of Contents

Absolute Maximum Ratings.....	4
JEDEC Moisture Sensitivity.....	4
Luminous Flux Characteristics for the Shwo series.....	5
PN of the Shwo series: White LEDs.....	6
PN of the Shwo series: Color LEDs.....	9
Optical Characteristics.....	19
Mechanical Dimension.....	20
Pad Configuration.....	21
Mechanical Dimension.....	22
(Only for ELSW-F61R1-0PPNM-AR5R6 and ELSW-F61O1-0PPNM-AR3R4).....	22
Pad Configuration.....	23
Wavelength Characteristics.....	25
Typical Light Output Characteristic V.S. Thermal Pad Temperature.....	27
Typical Electrical Characteristics.....	28
Typical Relative Luminous Flux V.S. Forward Current.....	29
Typical Wavelength & CCT Shift Characteristics.....	31
Current Derating Curves.....	33
Relative Flux and Forward Voltage V.S. Junction Temperature.....	34
Current Derating Curves.....	35
Emitter Tape Packaging.....	37
Emitter Tape Packaging.....	38
(Only for ELSW-F61R1-0PPNM-AR5R6 and ELSW-F61O1-0PPNM-AR3R4).....	38
Emitter Reel Packaging.....	39
Product Labeling.....	39
Storage Conditions.....	40
Revision History.....	46

## Product Nomenclature

The product name is designated as below:

### ELSW – ABCDE – FGHIJ – V1234

Designation:

AB = min. luminous flux (lm) or radiation power (mW) performance

C = radiation pattern <sup>[1]</sup>

D = color <sup>[2]</sup>

E = power consumption <sup>[3]</sup>

F = reserved for future product offerings

G = Internal code

H = packaging type <sup>[4]</sup>

IJ = internal code

V = forward voltage bin

1234 = color bin or CCT bin

#### Notes

1. Table of radiation patterns

Symbol	Description
1	Lambertian

2. Table of color offerings:

Symbol	Color	Dominant wavelength range
R	Red	620~630nm
O	Orange	610~620nm
Y	Amber	585~595nm
G	Green	520~535nm
B	Blue	460~470nm
C	Cool-White	4745~7050K
L	Royal-Blue	445~460nm
N	Neutral-White	3710~4745K
M	Warm-White	2580~3710K
E	Deep-Red	645~675nm

3. Table of power consumptions:

Symbol	Description
1	1W

4. Table of packaging types:

Symbol	Description
P	Tape

## Absolute Maximum Ratings

Parameter	Symbol	Ratings	Unit
Max. DC Forward Current (mA)	$I_F$	600 <sub>[1]</sub>	mA
Max. Peak Pulse Current (mA)	$I_{Pulse}$	1000 <sub>[2]</sub>	mA
Max. ESD Resistance	$V_B$	8000	V
Reverse Voltage	$V_R$	Note 3	V
Thermal Resistance	$R_{th}$	10 ~ 12 <sub>[4]</sub>	°C/W
Max. Junction Temperature	$T_J$	125 <sub>[5]</sub>	°C
Operating Temperature	$T_{Opr}$	-40 ~ +100 <sub>[6]</sub>	°C
Storage Temperature	$T_{Stg}$	-40 ~ +100	°C
Max. Soldering Temperature	$T_{Sol}$	260	°C
Max. Allowable Reflow Cycles	n/a	2	cycles

### Notes:

- Maximum forward current for 1W is 600mA (Thermal Pad=25°C).
- Duty cycle = 1/10@1KHZ
- The Shwo series LEDs are not designed for reverse bias use.
- Thermal Resistance is 10°C/W for Blue, Green, Cool-White, Neutral-White, and Warm-White LEDs and 12°C/W for Red, Amber, and Orange LEDs.
- Maximum junction temperature of Cool-White, Neutral-White, Warm-White, Blue, Green, Red, Amber, and Orange LEDs is 125°C.
- Maximum Operating Temperature (Thermal Pad) of Cool-White, Neutral-White, Warm-White, Blue, Green, Red, Amber, and Orange LEDs is 100°C.

## JEDEC Moisture Sensitivity

Level	Floor Life		Soak Requirements Standard	
	Time (hours)	Conditions	Time (hours)	Conditions
1	Unlimited	30°C / 85% RH	168 (+5/-0)	85°C / 85% RH

## Luminous Flux Characteristics for the Shwo series

Color	Part Number	1W	
		Minimum Luminous Flux(lm) or Radiometric Power(mW) <sup>[1]</sup>	Drive Current (mA)
Cool White	ELSW – F91CX	90	350
Neutral White	ELSW– F81NX	80	350
Warm White	ELSW– F61MX	60	350
	ELSW– F71MX	70	350
Red	ELSW – F51RX	52	350
	ELSW – F61RX	60	350
Orange	ELSW– F41OX	45	350
	ELSW– F51OX	52	350
	ELSW– F61OX	60	350
Amber	ELSW– F41YX	45	350
Green	ELSW– F71GX	70	350
	ELSW– F81GX	80	350
Blue	ELSW– E71BX	17	350
	ELSW– E81BX	20	350
Royal Blue	ELSW – Q91LX	275	350
Deep Red	ELSW – Q91EX	275	350
Far Red	ELSW – Q61FX	175	350

**Notes:**

1. Luminous flux measurement tolerance:  $\pm 10\%$ .
2. The data of luminous flux measured at thermal pad=25
3. Typical luminous flux or light output performance is operated within the condition guided by this datasheet.

## PN of the Shwo series: White LEDs

The table below is a list of part numbers for the Everlight Shwo 1W series White LED. All parts listed match ANSI binning standards. Bin offerings of 2700K to 6500K are listed and currently available. CRI is also listed with min 70 to 80. Typical view angle is 120°. These clearly listed binning options allow for proper design and implementation into lighting applications. The Order Codes below are currently available White Shwo LEDs.

For Example: If you order product using P/N **ELSW-F91C1-0LPGS-C5700**, you will be specifying:

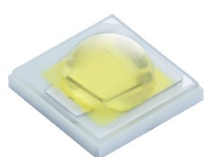

Color	Radiation Pattern	CRI	CCT	Forward Voltage (V)	Minimum Luminous Flux (lm)
Cool White	Lambertian	70	57K-1 ~ 57K-2 ~ 57K-3 ~ 57K-4	2.95~3.25(V1) 3.25~3.55(V2) 3.55~3.85(V3)	90

White, Shwo series LEDs at 350mA are listed below

Color	Order Code of ELSW	Minimum Luminous Flux (lm)	CCT (K) Wavelength (nm)	Forward Voltage (V)	CRI (min)
Cool White 6500	ELSW-F91C1-0LPGS-C6500	90	65K-1~65K-4	2.95~3.85	70
Cool White 5700	ELSW-F91C1-0LPGS-C5700	90	57K-1~57K-4	2.95~3.85	70
Cool White 5000	ELSW-F91C1-0LPGS-C5000	90	50K-1~50K-4	2.95~3.85	70
Neutral White 4500	ELSW-F81N1-0LPGS-C4500	80	45K-1~45K-4	2.95~3.85	75
Neutral White 4000	ELSW-F81N1-0LPGS-C4000	80	40K-1~40K-4	2.95~3.85	75
Warm White 3500	ELSW-F71M1-0LPGS-C3500	70	35K-1~35K-4	2.95~3.85	75
Warm White 3000	ELSW-F71M1-0LPGS-C3000	70	30K-1~30K-4	2.95~3.85	75
Warm White 2700	ELSW-F61M1-0LPGS-C2700	60	27K-1~27K-4	2.95~3.85	75

**Notes:**

1. CRI measurement tolerance:  $\pm 2$ .
2. Each 1W white PN is based on the min. bin, and includes two adjacent bins

## PN of the Shwo High Luminous Series: White LEDs

The table below is a list of part numbers for the Everlight Shwo 1W high luminous series White LED. All parts listed match ANSI binning standards. Bin offerings of 2700K to 6500K are listed and currently available. CRI is also listed with min 70 to 80. Typical view angle is 100°. These clearly listed binning options allow for proper design and implementation into lighting applications. The Order Codes below are currently available White Shwo LEDs.

For Example: If you order product using P/N **ELSW-J11C1-0CPGS-C5700**, you will be specifying:

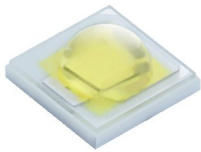

Color Variant	Radiation Pattern	CRI	CCT	Forward Voltage (V)	Minimum Luminous Flux (lm)
Cool White	Lambertian	70	57K-1 ~ 57K-2 ~ 57K-3 ~ 57K-4	2.65~2.95(U4) 2.95~3.25(V1) 3.25~3.55(V2)	100

White Shwo series LEDs at 350mA are listed below.

Color	Order Code of ELSW	Minimum Luminous Flux (lm)	CCT (K) Wavelength (nm)	Forward Voltage (V)	CRI (min)
Cool White 6500	ELSW-J11C1-0CPGS-C6500	100	65K-1~65K-4	2.65~3.55	70
	ELSW-J21C1-0VPGS-C6500	110	65K-1~65K-4	2.65~3.55	70
	ELSW-J31C1-0VPGS-C6500	120	65K-1~65K-4	2.65~3.55	70
	ELSW-J11C1-0VPHS-C6500	100	65K-1~65K-4	2.65~3.55	80
Cool White 5700	ELSW-J11C1-0CPGS-C5700	100	57K-1~57K-4	2.65~3.55	70
	ELSW-J21C1-0VPGS-C5700	110	57K-1~57K-4	2.65~3.55	70
	ELSW-J31C1-0VPGS-C5700	120	57K-1~57K-4	2.65~3.55	70
	ELSW-J11C1-0VPHS-C5700	100	57K-1~57K-4	2.65~3.55	80
Cool White 5000	ELSW-F91C1-0CPGS-C5000	90	50K-1~50K-4	2.65~3.55	70
	ELSW-J11C1-0VPGS-C5000	100	50K-1~50K-4	2.65~3.55	70
	ELSW-J21C1-0CPGS-C5000	110	50K-1~50K-4	2.65~3.55	70
	ELSW-J31C1-0CPGS-C5000	120	50K-1~50K-4	2.65~3.55	70
	ELSW-F91C1-0CPHS-C5000	90	50K-1~50K-4	2.65~3.55	80
Neutral White 4500	ELSW-F91N1-0CPGS-C4500	90	45K-1~45K-4	2.65~3.55	75
	ELSW-J11N1-0VPGS-C4500	100	45K-1~45K-4	2.65~3.55	75
Neutral White 4000	ELSW-F91N1-0CPGS-C4000	90	40K-1~40K-4	2.65~3.55	75
	ELSW-J11N1-0VPGS-C4000	100	40K-1~40K-4	2.65~3.55	75
	ELSW-F81N1-0VPHS-C4000	80	40K-1~40K-4	2.65~3.55	80
	ELSW-F91N1-0CPHS-C4000	90	40K-1~40K-4	2.65~3.55	80



Color	Order Code of ELSW	Minimum Luminous Flux (lm)	CCT (K) Wavelength (nm)	Forward Voltage (V)	CRI (min)
Warm White 3500	ELSW-F81M1-0CPGS-C3500	80	35K-1~35K-4	2.65~3.55	75
	ELSW-F91M1-0VPGS-C3500	90	35K-1~35K-4	2.65~3.55	75
	ELSW-F71M1-0CPHS-C3500	70	35K-1~35K-4	2.65~3.55	80
Warm White 3000	ELSW-F81M1-0CPGS-C3000	80	30K-1~30K-4	2.65~3.55	75
	ELSW-F91M1-0VPGS-C3000	90	30K-1~30K-4	2.65~3.55	75
	ELSW-F71M1-0CPHS-C3000	70	30K-1~30K-4	2.65~3.55	80
	ELSW-F81M1-0VPHS-C3000	80	30K-1~30K-4	2.65~3.55	80
	ELSW-F91M1-0VPHS-C3000	90	30K-1~30K-4	2.65~3.55	80
Warm White 2700	ELSW-F71M1-0CPGS-C2700	70	27K-1~27K-4	2.65~3.55	75
	ELSW-F81M1-0CPGS-C2700	80	27K-1~27K-4	2.65~3.55	75
	ELSW-F91M1-0VPGS-C2700	90	27K-1~27K-4	2.65~3.55	75
	ELSW-F61M1-0CPHS-C2700	60	27K-1~27K-4	2.65~3.55	80
	ELSW-F71M1-0CPHS-C2700	70	27K-1~27K-4	2.65~3.55	80
	ELSW-F81M1-0VPHS-C2700	80	27K-1~27K-4	2.65~3.55	80
	ELSW-F91M1-0VPHS-C2700	90	27K-1~27K-4	2.65~3.55	80

**Notes:**

1. CRI measurement tolerance:  $\pm 2$ .
2. Each 1W white PN is based on the min. bin, and includes two adjacent bins



## PN of the Shwo series: Color LEDs

The table below is a list of the binning options for the Everlight Shwo 1W series Color LED. Standard Everlight color bins are listed according to wavelength and represent the standard primary colors of the spectrum. Typical view angle is 120°. These clearly listed binning options allow for proper design and implementation into lighting applications. The Order Codes below are currently available Color Shwo LEDs. For Example: If you order product using P/N **ELSW-F51R1-0LPNM-AR5R6**, you will be specifying:

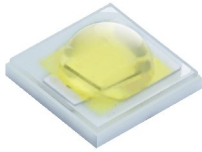

Color Variant	Radiation Pattern	Dominant Wavelength (nm)	Forward Voltage (V)	Minimum Luminous Flux (lm)
Red	Lambertian	620~625(R5) 625~630(R6)	1.75~2.05(U1) 2.05~2.35(U2) 2.35~2.65(U3) 2.65~2.95(U4)	52

Color, Shwo series LEDs at 350mA are listed below.

Color	Order Code of ELSW	Minimum Luminous Flux (lm)	Wavelength (nm)	Forward Voltage(V)
Red	*ELSW-F51R1-0LPNM-AR5R6	52	620~630	1.75~2.95
	<b>*ELSW-F61R1-0PPNM-AR5R6</b>	<b>60</b>	<b>620~630</b>	<b>1.75~2.95</b>
Orange	ELSW-F51O1-0LPNM-AR3R4	52	610~620	1.75~2.95
	<b>ELSW-F61O1-0PPNM-AR3R4</b>	<b>60</b>	<b>610~620</b>	<b>1.75~2.95</b>
Amber	ELSW-F41Y1-0LPNM-AA3A5	45	585~592.5	1.75~2.95
Green	ELSW-F71G1-0LPNM-CG1G2	70	520~530	2.95~3.85
	ELSW-F71G1-0LPNM-CG2G3	70	525~535	2.95~3.85
	*ELSW-F81G1-0GPNM-CG1G2	80	520~530	2.95~3.85
Blue	*ELSW-E71B1-0LPNM-CB7B8	17	460~470	2.95~3.85
	*ELSW-E81B1-0LPNM-CB7B8	20	460~470	2.95~3.85

\*Product lead time of at least 8 weeks

### Notes:

- Mechanical dimension and pad configuration of ELSW-F61R1-0PPNM-AR5R6 and ELSW-F61O1-0PPNM-AR3R4, please refer to Page.21-22. Marked in red above.  
Each 1W direct color PN is based on the min. bin and includes four adjacent bins.

Color	Order Code of ELSH	Minimum Radiometric Power (mW)	Peak Wavelength (nm)	Forward Voltage(V)
	ELSW-Q91L1-0LPNM-CB4B6	275	445~460	2.95~3.85
	*ELSW-Q91E1-0LPNM-AD3D8	275	645~675	1.75~2.95
	*ELSW-Q61F1-0LPNM-AF3F8	125	715~745	1.75~2.95

\*Product lead time of at least 8 weeks.

**Note:**

Each 1W direct color PN is based on the min. bin and includes four adjacent bins.

Royal Blue

Deep Red

Far Red

EVERLIGHT

## Product Binning

### Luminous Flux Bins

Group	Bin	Minimum Photometric Flux (lm)	Maximum Photometric Flux (lm)
E	1	4	5
	2	5	6
	3	6	8
	4	8	10
	5	10	13
	6	13	17
	7	17	20
	8	20	23
	9	23	27
F	1	27	33
	2	33	39
	3	39	45
	4	45	52
	5	52	60
	6	60	70
	7	70	80
	8	80	90
	9	90	100

Group	Bin	Minimum Photometric Flux (lm)	Maximum Photometric Flux (lm)
J	1	100	110
	2	110	120
	3	120	130
	4	130	140
	5	140	150
	6	150	160
	7	160	180
	8	180	200
	9	200	225
K	1	225	250
	2	250	275
	3	275	300
	4	300	325
	5	325	350
	6	350	375
	7	375	400
	8	400	425
	9	425	450
N	1	450	475
	2	475	500
	3	500	525
	4	525	550

### Radiometric Power Bins

Group	Bin	Minimum Radiometric Power(mW)	Maximum Radiometric Power(mW)
Q	1	0	25
	2	25	50
	3	50	75
	4	75	100
	5	100	125
	6	125	175
	7	175	225
	8	225	275
	9	275	350

Group	Bin	Minimum Radiometric Power(mW)	Maximum Radiometric Power(mW)
R	1	350	425
	2	425	500
	3	500	600
	4	600	700
	5	700	800
	6	800	900
	7	900	1000
	8	1000	1300
	9	1300	1600

### White Bin Structure

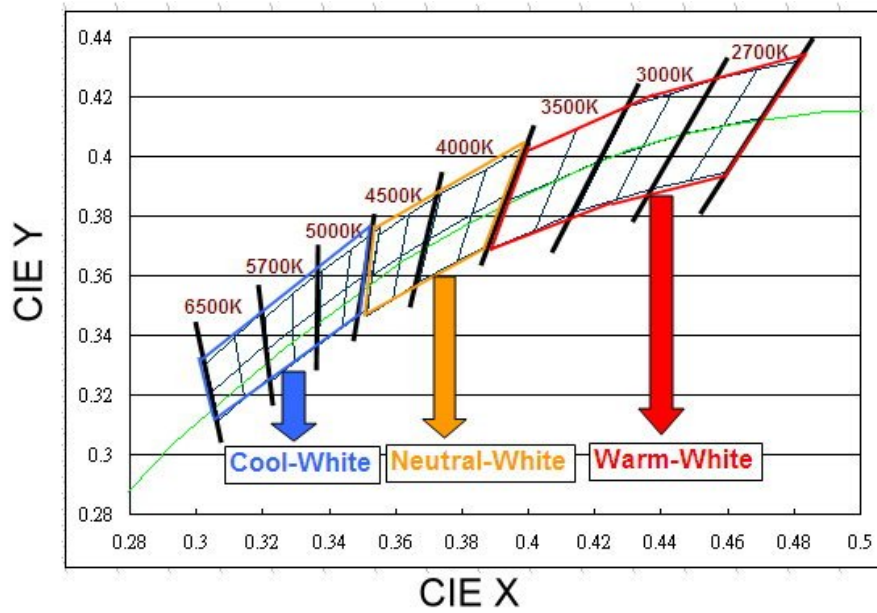

Chromaticity specification defined by ANSI

**Notes:**

1. The CCT range of Cool-White varies from 4745K to 7050K.
2. The CCT range of Neutral-White varies from 3710K to 4745K.
3. The CCT range of Warm-White varies from 2580K to 3710K
4. Color coordinates measurement allowance :  $\pm 0.01$
5. Color bins are defined at  $I_F=350\text{mA}$  operation.

### Cool-White Bin Structure

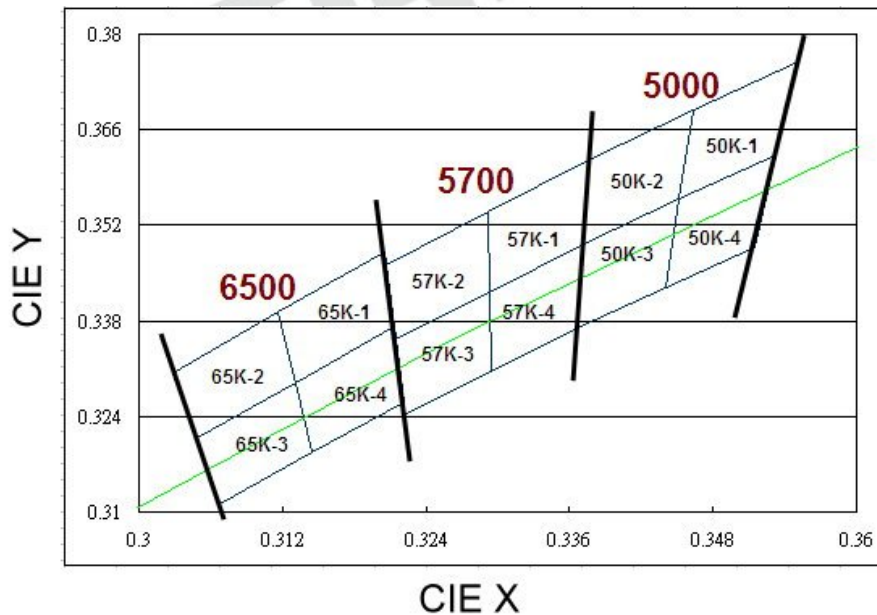

Cool-White Bin Coordinates

5000K

Bin	CIE X	CIE Y
50K-1	0.346	0.369
	0.345	0.356
	0.353	0.362
	0.355	0.376
Reference Range: 4745~5000K		

Bin	CIE X	CIE Y
50K-2	0.338	0.362
	0.337	0.349
	0.345	0.356
	0.346	0.369
Reference Range: 5000~5310K		

Bin	CIE X	CIE Y
50K-4	0.345	0.356
	0.344	0.343
	0.352	0.349
	0.353	0.362
Reference Range: 4745~5000K		

Bin	CIE X	CIE Y
50K-3	0.337	0.349
	0.337	0.337
	0.344	0.343
	0.345	0.356
Reference Range: 5000~5310K		

5700K

Bin	CIE X	CIE Y
57K-1	0.329	0.354
	0.329	0.342
	0.337	0.349
	0.338	0.362
Reference Range: 5310~5700K		

Bin	CIE X	CIE Y
57K-2	0.321	0.346
	0.321	0.335
	0.329	0.342
	0.329	0.354
Reference Range: 5700~6020K		

Bin	CIE X	CIE Y
57K-4	0.329	0.342
	0.329	0.331
	0.337	0.337
	0.337	0.349
Reference Range: 5310~5700K		

Bin	CIE X	CIE Y
57K-3	0.321	0.335
	0.322	0.324
	0.329	0.331
	0.329	0.342
Reference Range: 5700~6020K		

6500K

Bin	CIE X	CIE Y
65K-1	0.312	0.339
	0.313	0.329
	0.321	0.337
	0.321	0.348
Reference Range: 6020~6500K		

Bin	CIE X	CIE Y
65K-2	0.303	0.330
	0.305	0.321
	0.313	0.329
	0.312	0.339
Reference Range: 6500~7050K		

Bin	CIE X	CIE Y
65K-4	0.313	0.329
	0.315	0.319
	0.322	0.326
	0.321	0.337
Reference Range: 6020~6500K		

Bin	CIE X	CIE Y
65K-3	0.305	0.321
	0.307	0.311
	0.315	0.319
	0.313	0.329
Reference Range: 6500~7050K		

### Neutral-White Bin Structure

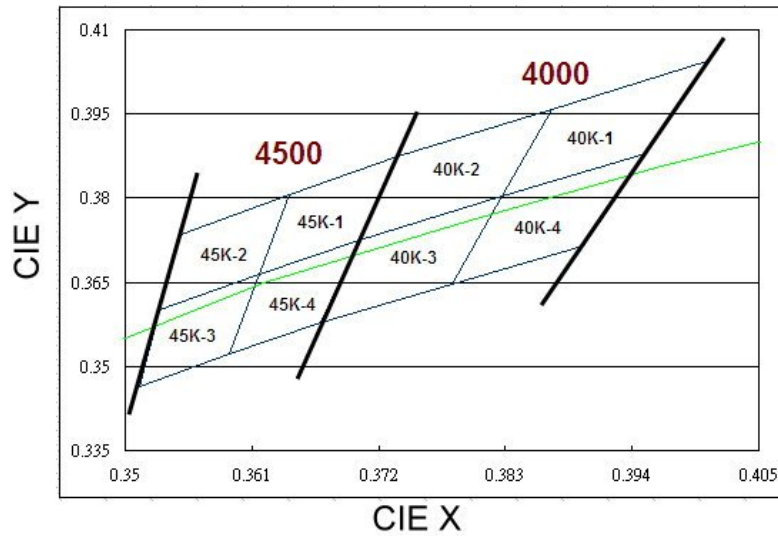

### Neutral-White Bin Coordinates

#### 4000K

Bin	CIE X	CIE Y
40K-1	0.387	0.396
	0.383	0.380
	0.395	0.388
	0.401	0.404
Reference Range: 3710~4000K		

Bin	CIE X	CIE Y
40K-2	0.374	0.387
	0.370	0.373
	0.383	0.380
	0.387	0.396
Reference Range: 4000~4260K		

Bin	CIE X	CIE Y
40K-4	0.383	0.380
	0.378	0.365
	0.390	0.372
	0.395	0.388
Reference Range: 3710~4000K		

Bin	CIE X	CIE Y
40K-3	0.370	0.373
	0.367	0.358
	0.378	0.365
	0.383	0.380
Reference Range: 4000~4260K		

#### 4500K

Bin	CIE X	CIE Y
45K-1	0.364	0.381
	0.362	0.366
	0.370	0.373
	0.374	0.387
Reference Range: 4260~4500K		

Bin	CIE X	CIE Y
45K-2	0.355	0.374
	0.353	0.360
	0.362	0.366
	0.364	0.381
Reference Range: 4500~4745K		

Bin	CIE X	CIE Y
45K-4	0.362	0.366
	0.359	0.352
	0.367	0.358
	0.370	0.373
Reference Range: 4260~4500K		

Bin	CIE X	CIE Y
45K-3	0.353	0.360
	0.351	0.347
	0.359	0.352
	0.362	0.366
Reference Range: 4500~4745K		

### Warm-White Bin Structure

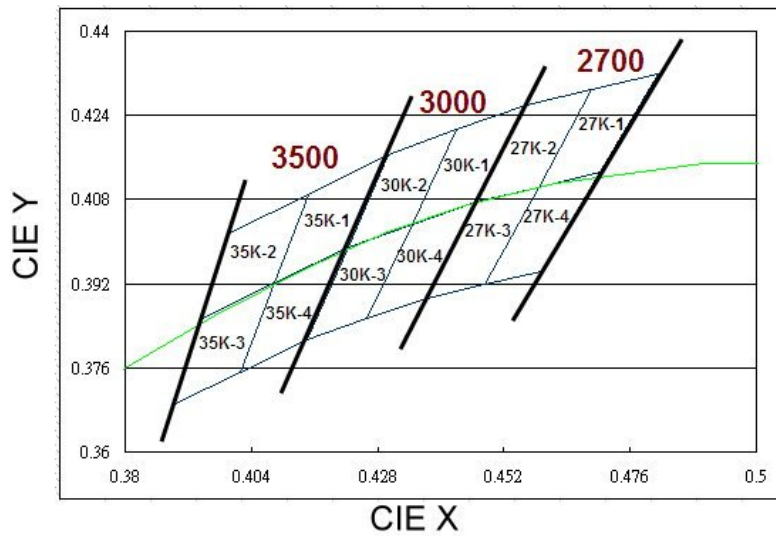

### Warm-White Bin Coordinates

#### 2700K

Bin	CIE X	CIE Y
27K-1	0.469	0.429
	0.459	0.410
	0.470	0.413
	0.481	0.432
Reference Range: 2580~2700K		

Bin	CIE X	CIE Y
27K-2	0.456	0.426
	0.447	0.408
	0.459	0.410
	0.469	0.429
Reference Range: 2700~2870K		

Bin	CIE X	CIE Y
27K-4	0.459	0.410
	0.448	0.392
	0.459	0.394
	0.470	0.413
Reference Range: 2580~2700K		

Bin	CIE X	CIE Y
27K-3	0.447	0.408
	0.437	0.389
	0.448	0.392
	0.459	0.410
Reference Range: 2700~2870K		



**3000K**

Bin	CIE X	CIE Y
30K-1	0.443	0.421
	0.435	0.403
	0.447	0.408
	0.456	0.426
Reference Range: 2870~3000K		

Bin	CIE X	CIE Y
30K-2	0.430	0.417
	0.422	0.399
	0.435	0.403
	0.443	0.421
Reference Range: 3000~3220K		

Bin	CIE X	CIE Y
30K-4	0.435	0.403
	0.426	0.385
	0.437	0.389
	0.447	0.408
Reference Range: 2870~3000K		

Bin	CIE X	CIE Y
30K-3	0.422	0.399
	0.415	0.381
	0.426	0.385
	0.435	0.403
Reference Range: 3000~3220K		

**3500K**

Bin	CIE X	CIE Y
35K-1	0.415	0.409
	0.408	0.392
	0.422	0.399
	0.430	0.417
Reference Range: 3220~3500K		

Bin	CIE X	CIE Y
35K-2	0.400	0.402
	0.394	0.385
	0.408	0.392
	0.415	0.409
Reference Range: 3500~3710K		

Bin	CIE X	CIE Y
35K-4	0.408	0.392
	0.402	0.375
	0.415	0.381
	0.422	0.399
Reference Range: 3220~3500K		

Bin	CIE X	CIE Y
35K-3	0.394	0.385
	0.389	0.369
	0.402	0.375
	0.408	0.392
Reference Range: 3500~3710K		

**Note:** Currently available typical CCT ranges are 3000K, 5700K, and 6500K CCT.

### Forward Voltage Bins

Group Name	Bins
A	U1+U2+U3+U4
B	U2+U3+U4+V1
C	U4+V1+V2+V3
D	V1+V2+V3+V4

Bin	Minimum Forward Voltage (V)	Maximum Forward Voltage (V)
U1	1.75	2.05
U2	2.05	2.35
U3	2.35	2.65
U4	2.65	2.95
V1	2.95	3.25
V2	3.25	3.55
V3	3.55	3.85
V4	3.85	4.15

**Notes:**

1. Forward voltage measurement tolerance:  $\pm 0.1V$ .
2. Forward voltage bins are defined at  $I_f=350mA$  operation.
3. Other Forward Voltage bins for White LEDs available upon request. Please contact your local Everlight sales office.

**Color Bins**

Group	Bin	Minimum Dominant	Maximum Dominant
		Wavelength (nm)	Wavelength (nm)
<b>B</b> (Blue)	1	430	435
	2	435	440
	3	440	445
	4	445	450
	5	450	455
	6	455	460
	7	460	465
	8	465	470
<b>G</b> (Green)	1	520	525
	2	525	530
	3	530	535
	4	535	540
	5	540	545
	6	545	550
<b>A</b> (Amber)	1	580	582.5
	2	582.5	585
	3	585	587.5
	4	587.5	590
	5	590	592.5
	6	592.5	595
<b>R</b> (Red)	3	610	615
	4	615	620
	5	620	625
	6	625	630

**Notes:**

1. Dominant wavelength measurement tolerance:  $\pm 0.1\text{nm}$ .
2. Dominant wavelength bins are defined at  $I_F=350\text{mA}$  operation.

## Optical Characteristics

Color	Part Number	Dominant Wavelength $\lambda_D$ Peak Wavelength $\lambda_P$ Color Temperature CCT			Typical Temperature Coefficient of Dominant Wavelength (nm/°C)-( $\lambda_D / T_J$ )	Typical Viewing Angle (degrees) $2\theta_{1/2}$
		Min.	Typ.	Max.		
Cool-White	ELSW – XX1CX	4745K	5700K	7050K	---	Note 5
Neutral-White	ELSW – XX1NX	3710K	4260K	4745K	---	Note 5
Warm-White	ELSW – XX1MX	2580K	3000K	3710K	---	Note 5
Red	ELSW – XX1RX	620nm	---	630nm	0.05	120
Orange	ELSW – XX1OX	610nm	---	620nm	0.08	120
Amber	ELSW – XX1YX	585nm	---	595nm	0.1	120
Green	ELSW – XX1GX	520nm	---	535nm	0.05	120
Blue	ELSW – XX1BX	460nm	---	470nm	0.05	120
Deep-Red	ELSW – XX1EX	645nm	---	675nm	0.08	120
Far-Red	ELSW – XX1FX	715nm	---	745nm	0.04	120

### Notes:

1. The test tolerance of Everlight is  $\pm 0.5\text{nm}$  for dominant wavelength,  $\pm 5\%$  for CCT.
2. Viewing angle is the width of half the light output intensity in all directions of  $180^\circ$ .
3. All Cool-White, Neutral-White, Warm-White, and dominant wavelength below 550nm LEDs are made with Indium Gallium Nitride (InGaN).
4. All LEDs with dominant wavelength exceeding 550nm are made with Aluminum Indium Gallium Phosphide (AlInGaP).
5. Typical view angle of ELSW-XX1XX-0C and ELSW-XX1XX-0V series is  $100^\circ$ . Typical view angle of ELSW-XX1XX-0L series is  $120^\circ$ .

## Mechanical Dimension

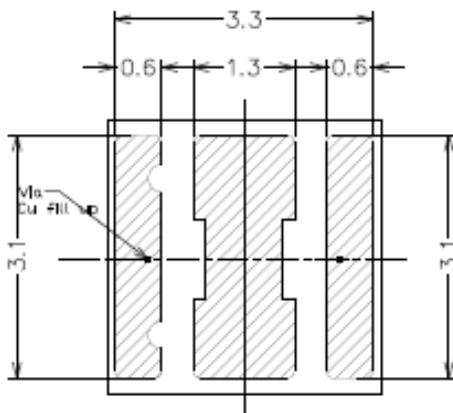
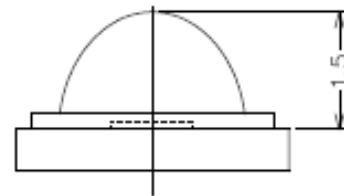
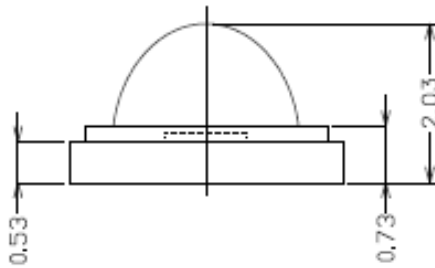
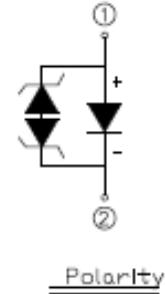
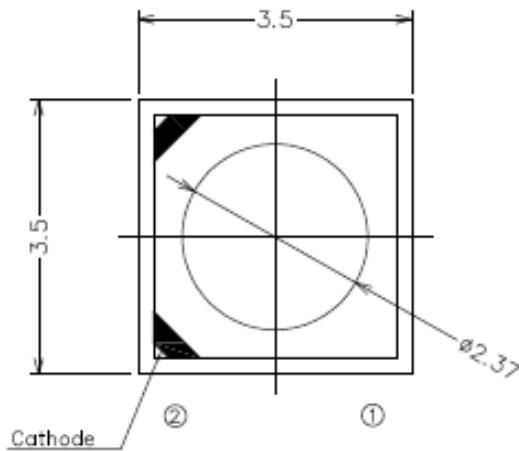

Solder pad design

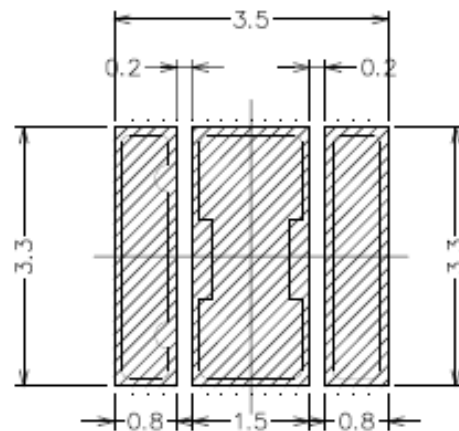

Soldering patterns

### Notes:

1. Dimensions are in millimeters.
2. Tolerances unless mentioned are  $\pm 0.15\text{mm}$ .
3. The thermal pad is electrically isolated from the Anode and Cathode contact pads.
4. Do not handle the device by the lens. Incorrect force applied to the lens may lead to the failure of devices.

## Pad Configuration

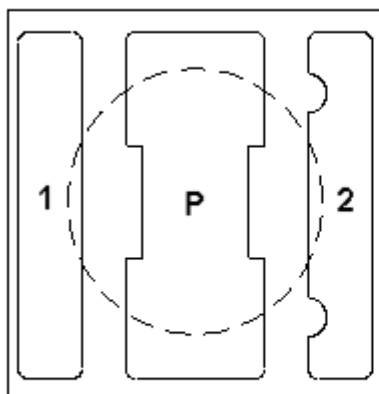

BOTTOM VIEW

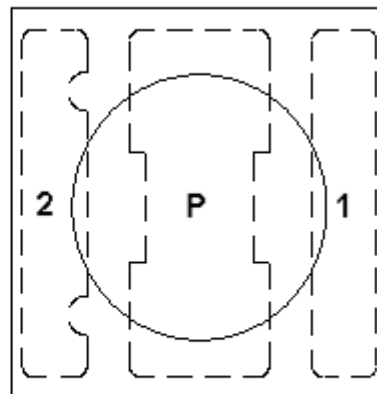

TOP VIEW

PAD	FUNCTION
1	ANODE
2	CATHODE
P	THERMAL PAD

**Mechanical Dimension**  
**(Only for ELSW-F61R1-0PPNM-AR5R6 and ELSW-F61O1-0PPNM-AR3R4)**

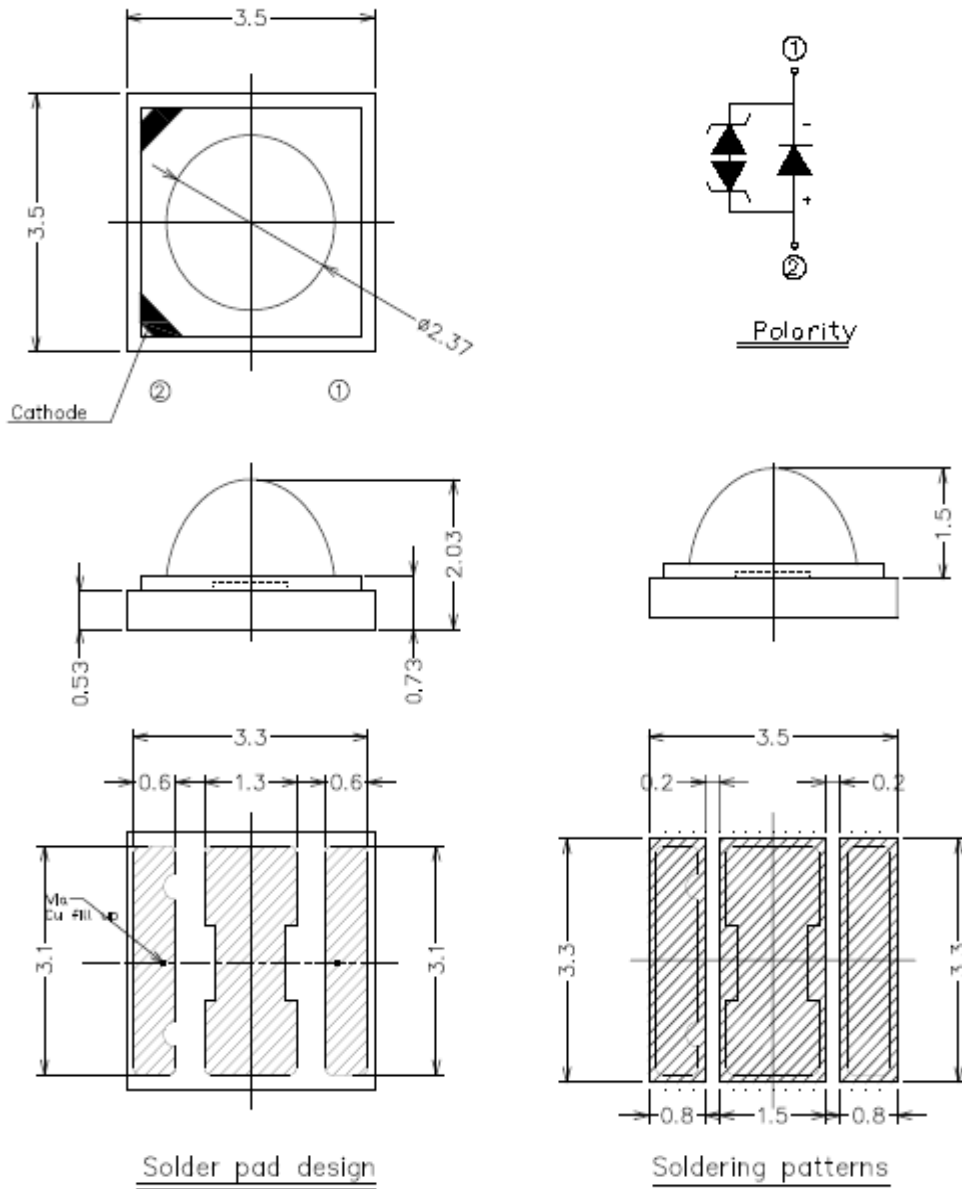

**Notes:**

1. Dimensions are in millimeters.
2. Tolerances unless mentioned are  $\pm 0.15\text{mm}$ .
3. The thermal pad is electrically isolated from the Anode and Cathode contact pads.
4. Only for ELSW-F61R1-0PPNM-AR5R6 and ELSW-F61O1-0PPNM-AR3R4.
5. Do not handle the device by the lens. Incorrect force applied to the lens may lead to the failure of devices.



**Pad Configuration**  
**(Only for ELSW-F61R1-0PPNM-AR5R6 and ELSW-F61O1-0PPNM-AR3R4)**

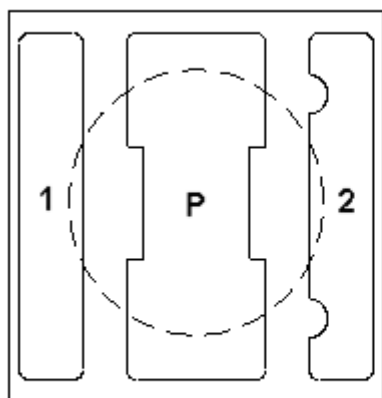

BOTTOM VIEW

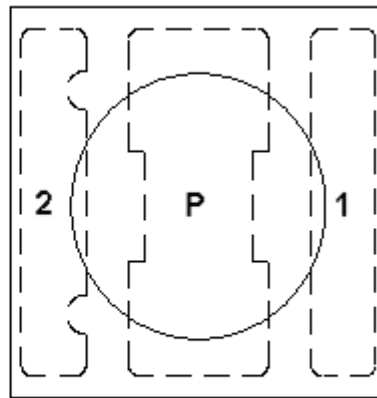

TOP VIEW

PAD	FUNCTION
1	<b>CATHODE</b>
2	<b>ANODE</b>
P	THERMAL PAD

**Note:**

Only for ELSW-F61R1-0PPNM-AR5R6 and ELSW-F61O1-0PPNM-AR3R4.

## Reflow Soldering Characteristics

### For Reflow Process

- ELSW series are suitable for SMT processes.
- Curing of glue in oven must be according to standard operation flow processes.

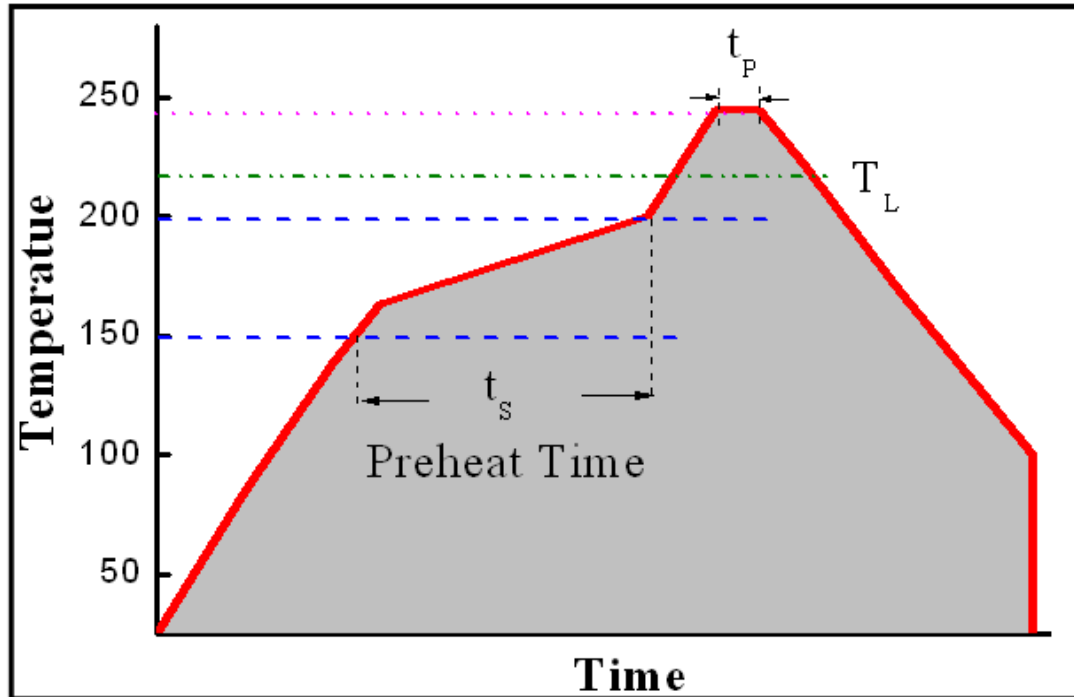

Profile Feature	Lead Free Assembly
Ramp-Up Rate	2-3 °C/S
Preheat Temperature	150-200 °C
Preheat Time ( $t_s$ )	60-120 S
Liquid Temperature ( $T_L$ )	217 °C
Time maintained above $T_L$	60-90 S
Peak Temperature ( $T_P$ )	240±5 °C
Peak Time ( $t_p$ )	Max 20 S
Ramp-Down Rate	3-5 °C/S

- Reflow soldering should not be done more than twice.
- In soldering process, stress on the LEDs during heating should be avoided.
- After soldering, do not bend the circuit board.

## Wavelength Characteristics

For Red, Amber, Yellow, Green, Blue  
@ Thermal Pad Temperature = 25

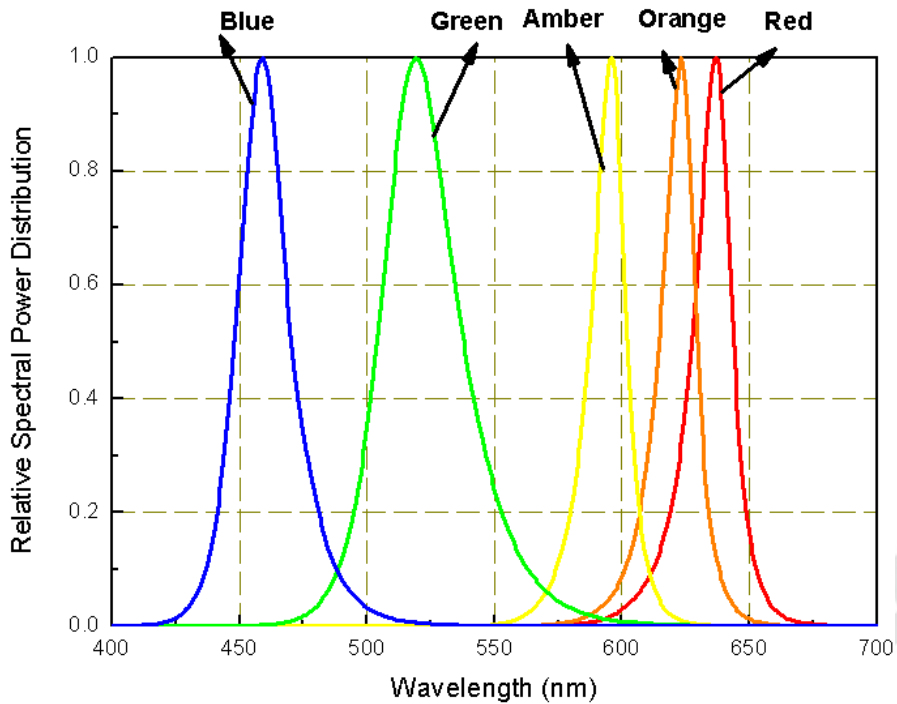

For Cool-White, @ Thermal Pad Temperature = 25

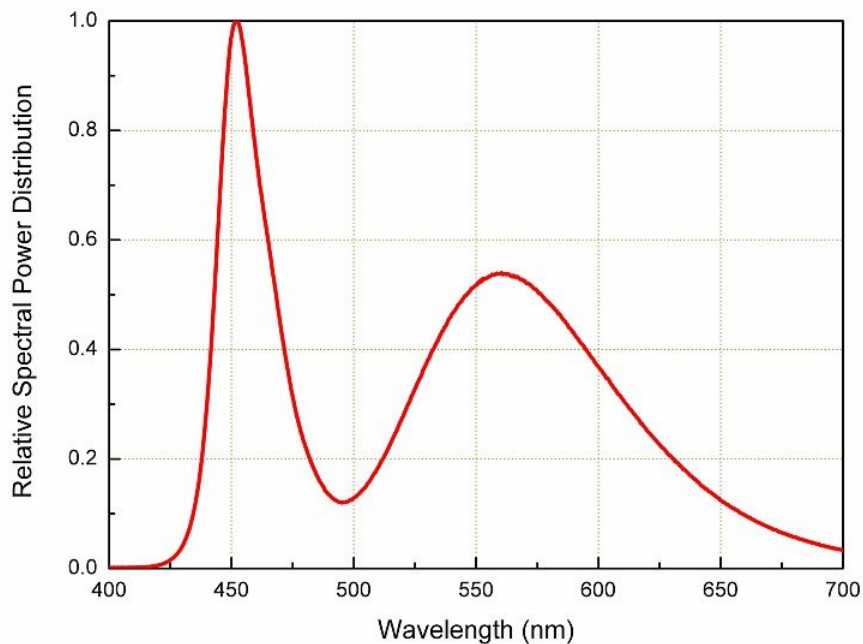

For Neutral-White, @ Thermal Pad Temperature = 25

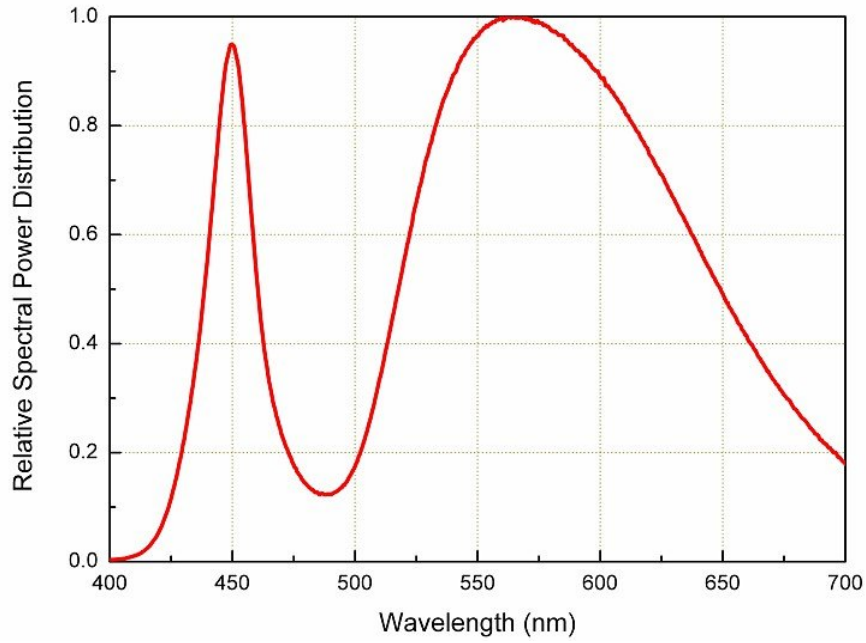

For Warm-White, @ Thermal Pad Temperature = 25

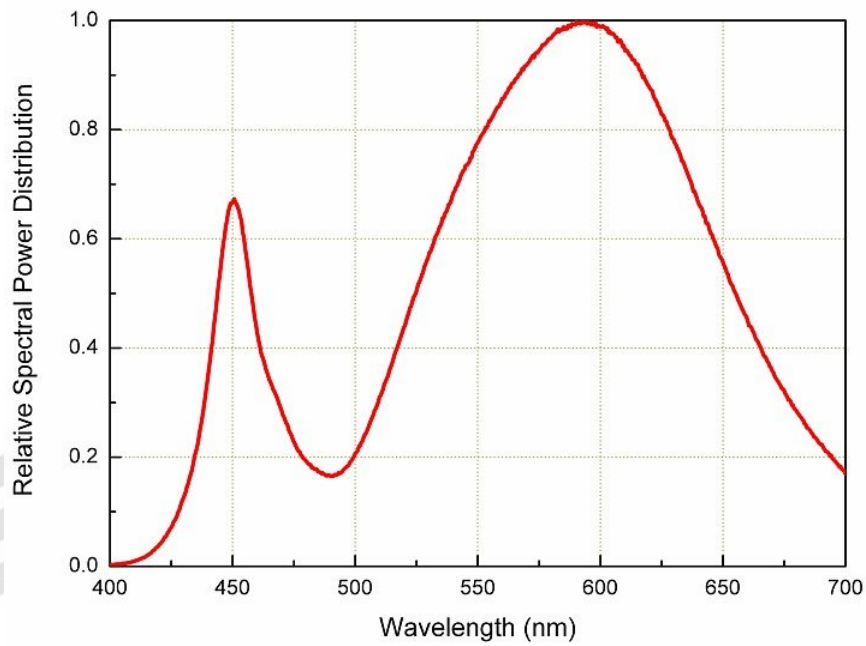

## Typical Light Output Characteristic V.S. Thermal Pad Temperature

Cool-White, Neutral-White, Warm-White, Green, Blue  
for 350mA Drive Current

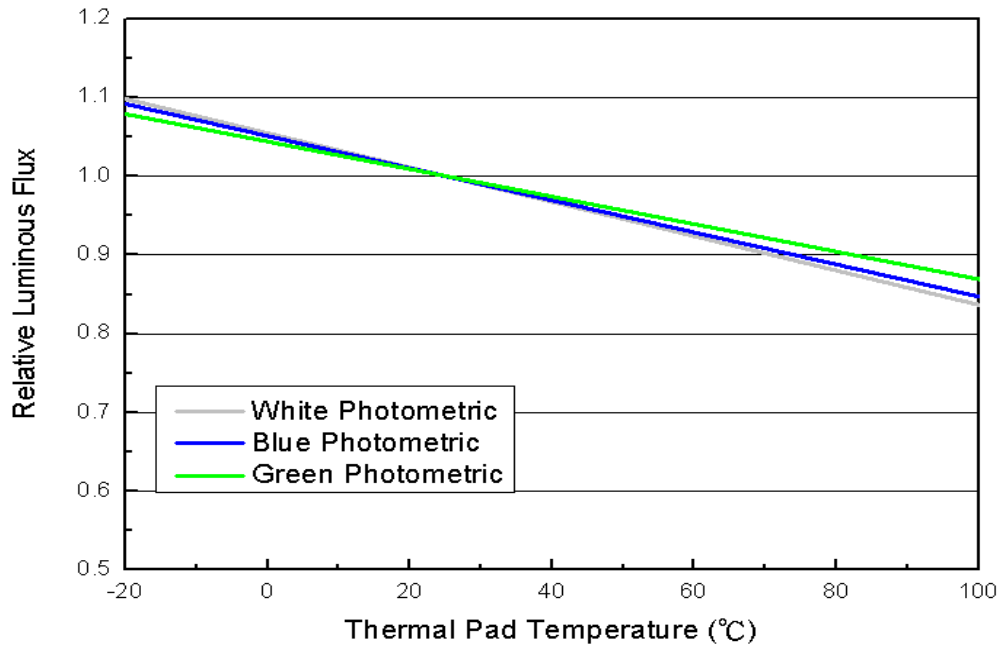

Red, Orange, Amber for 350mA Drive Current

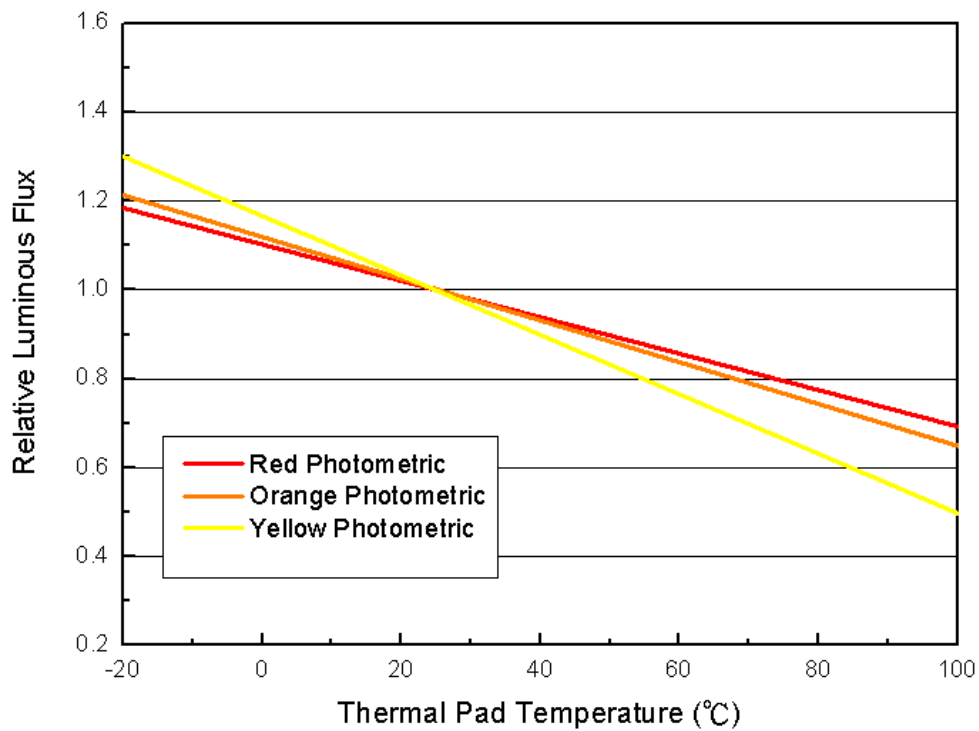

## Typical Electrical Characteristics

For Cool-White, Neutral-White, Warm-White, Green, Blue  
@ Thermal Pad Temperature = 25

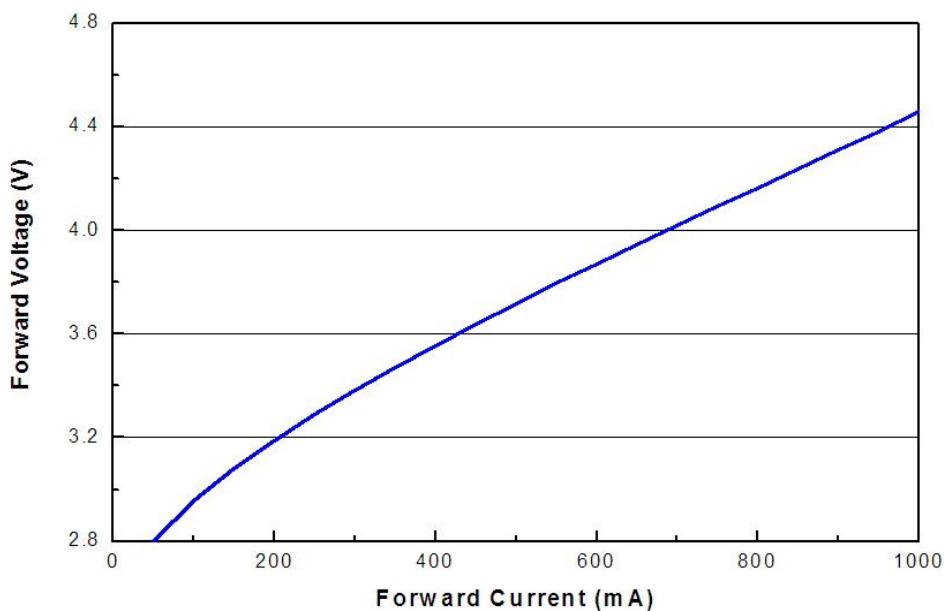

For Red, Orange, Amber,  
@ Thermal Pad Temperature = 25

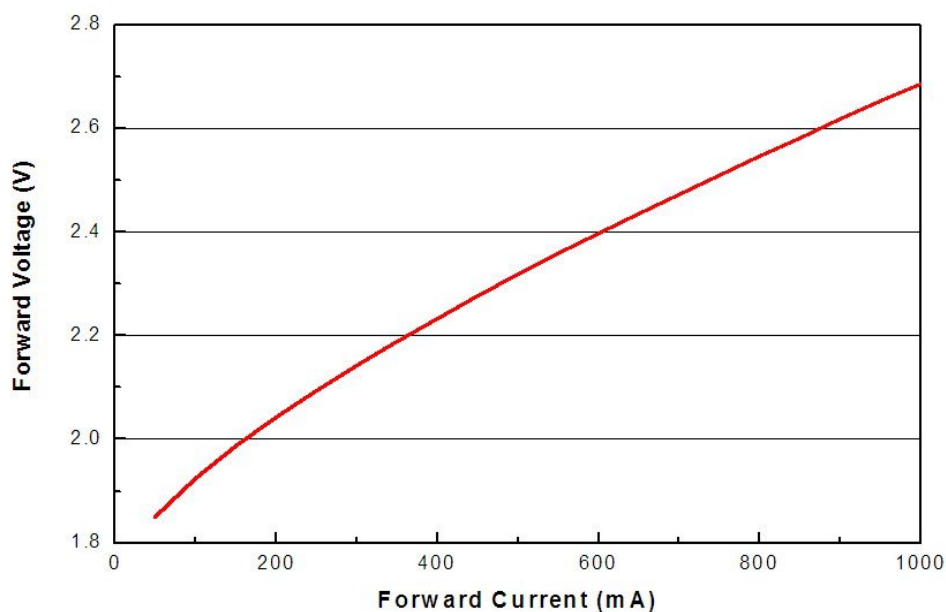

## Typical Relative Luminous Flux V.S. Forward Current

For Cool-White, Neutral-White, Warm-White  
@ Thermal Pad Temperature = 25

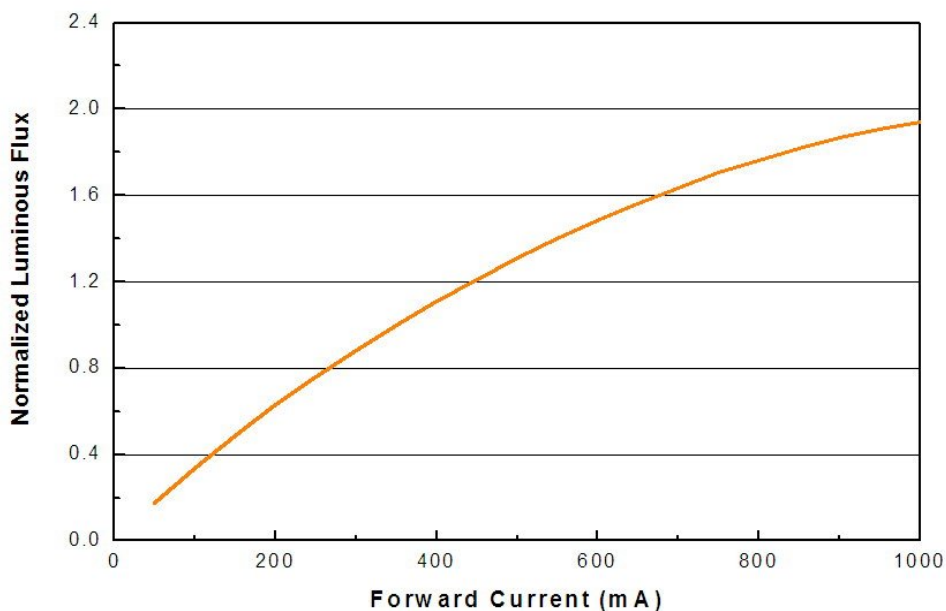

For Green, Blue, @ Thermal Pad Temperature = 25

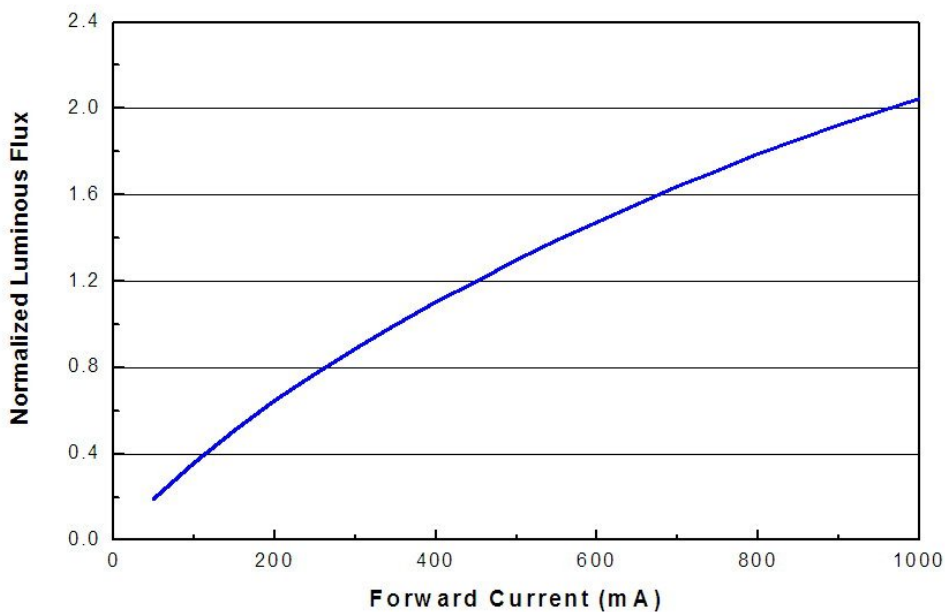



For Red, Orange, Amber,  
@ Thermal Pad Temperature = 25

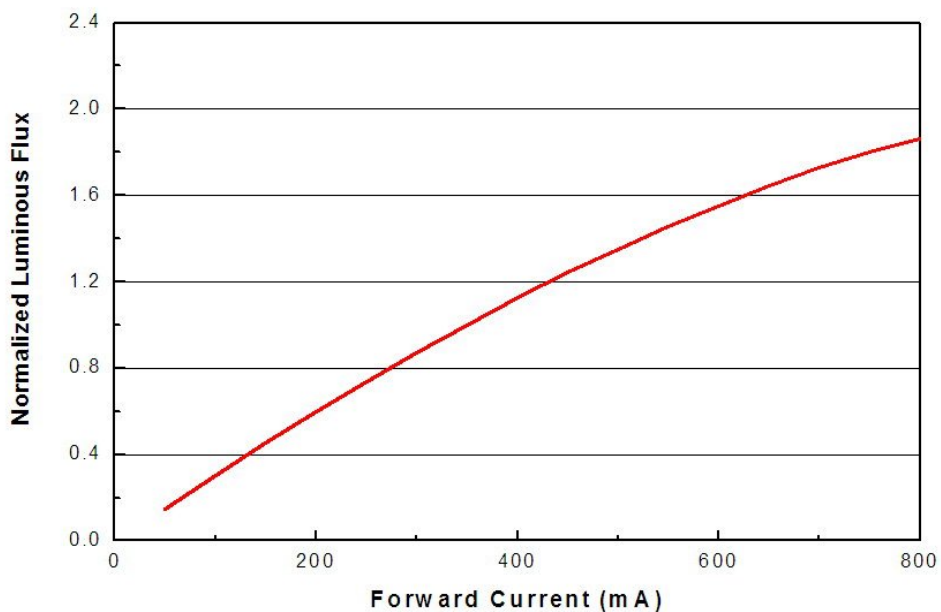

EVERLIGHT

## Typical Wavelength & CCT Shift Characteristics V.S. Forward Current

For Cool-White @ Thermal Pad Temperature = 25

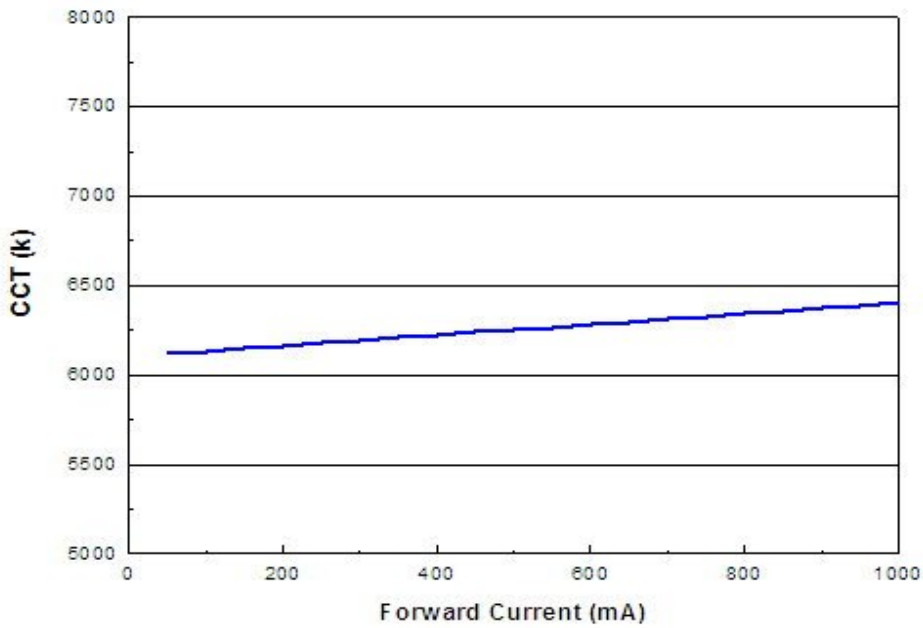

For Neutral-White @ Thermal Pad Temperature = 25

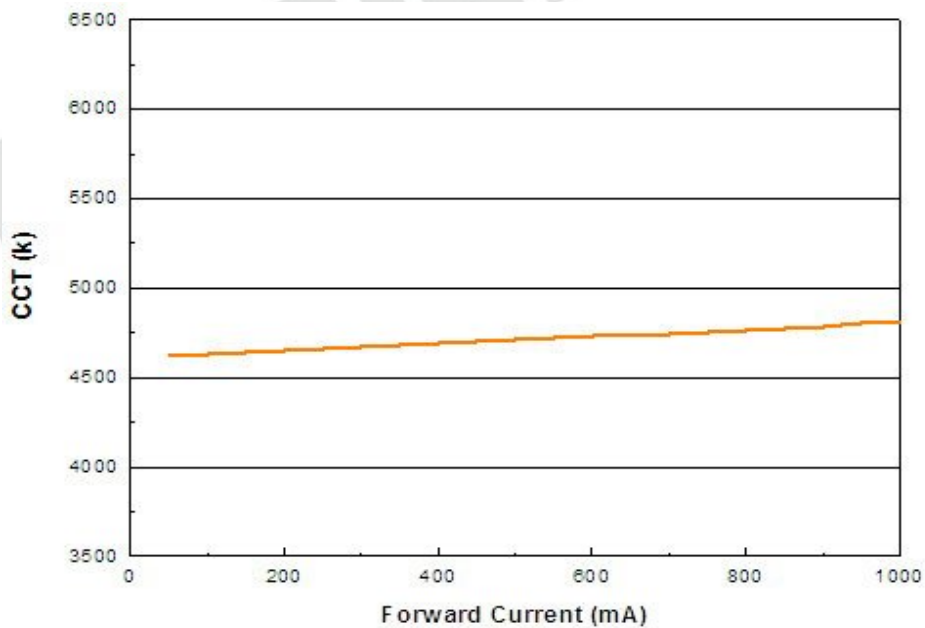

For Warm-White @ Thermal Pad Temperature = 25

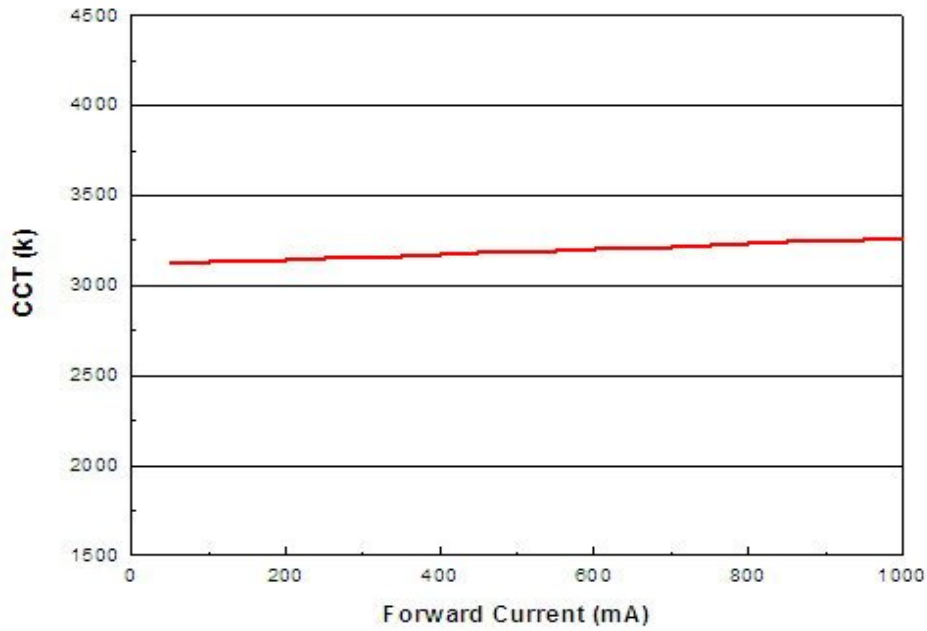

For Blue @ Thermal Pad Temperature = 25

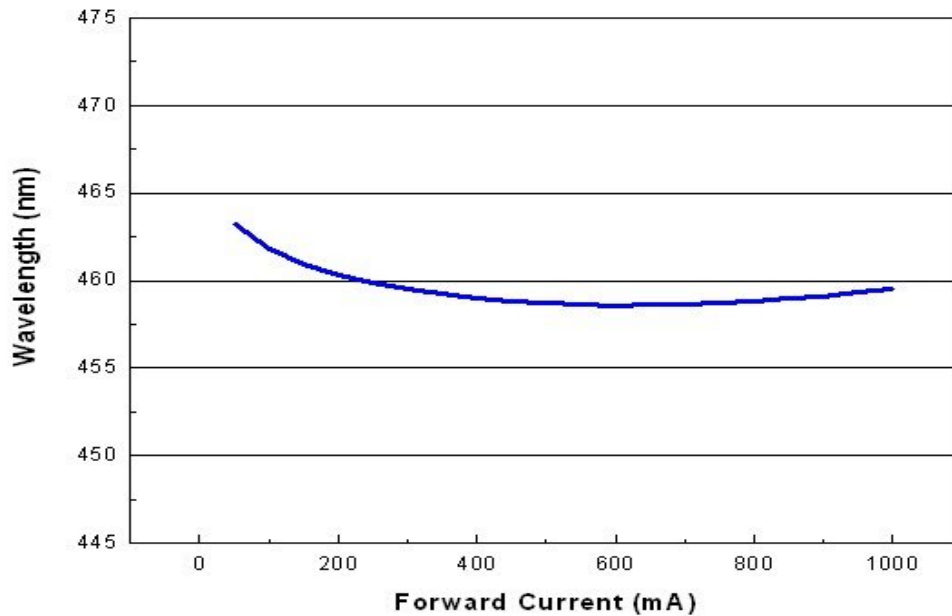

For Green @ Thermal Pad Temperature = 25

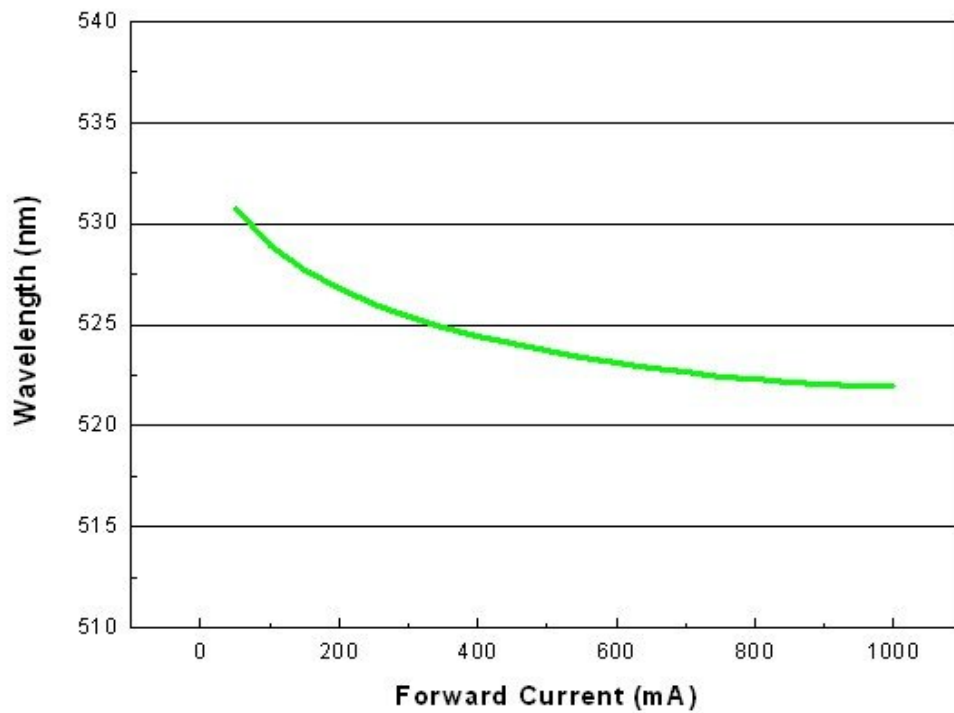

For Red @ Thermal Pad Temperature = 25

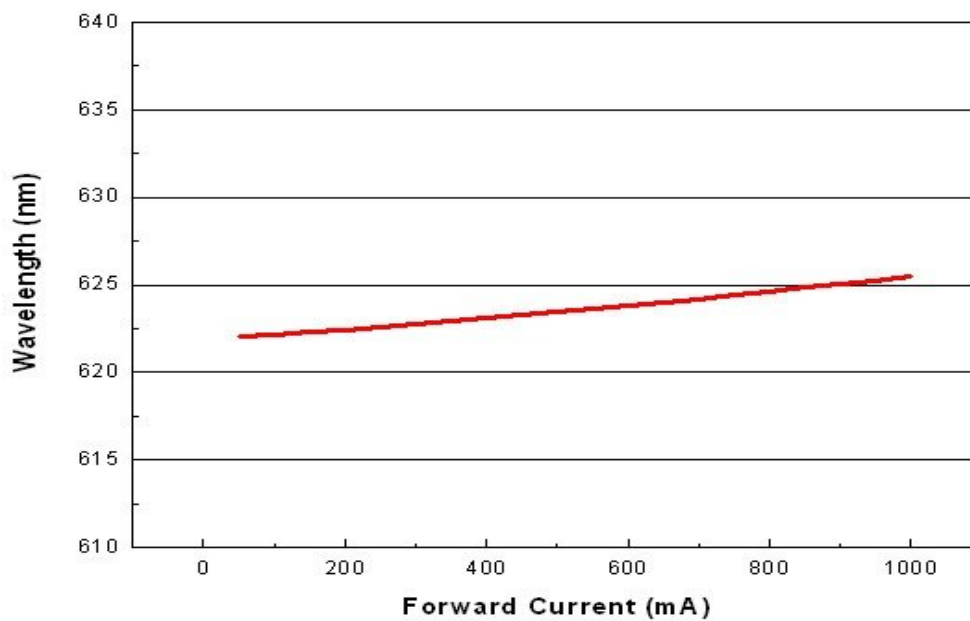

## Relative Flux and Forward Voltage V.S. Junction Temperature (IF = 350 mA)

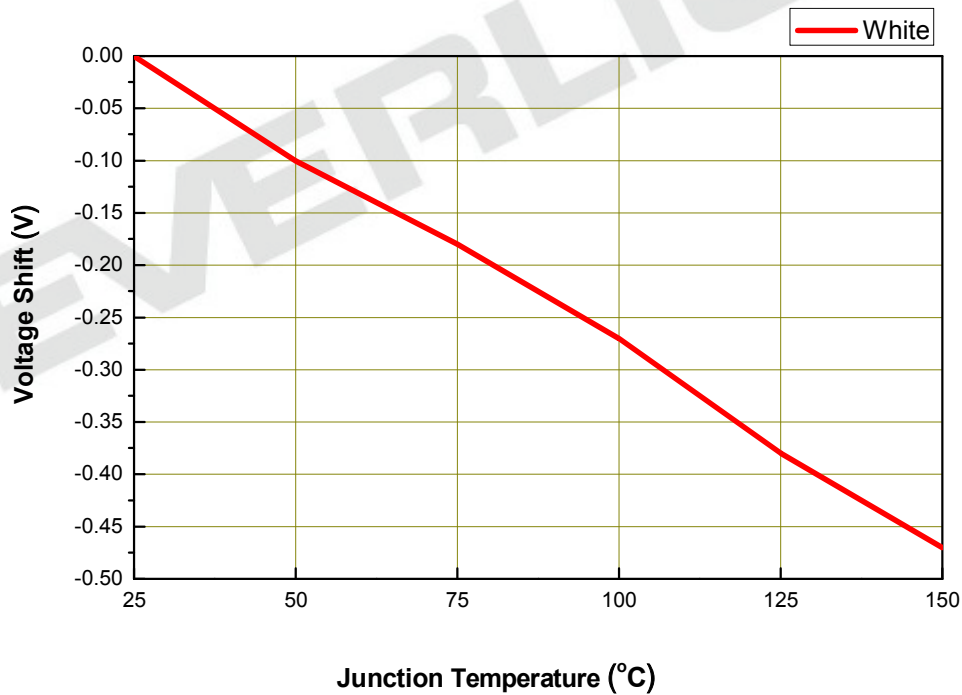
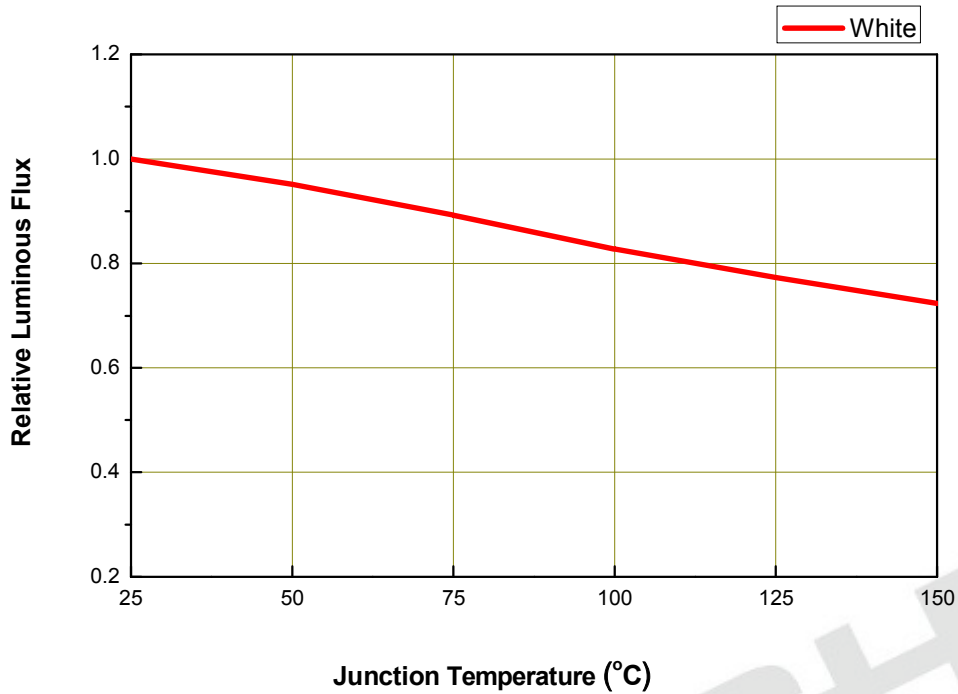

## Current Derating Curves

**Current Derating Curve for 350mA Drive Current  
Cool-White, Neutral-White, Warm-White, Green, Blue**

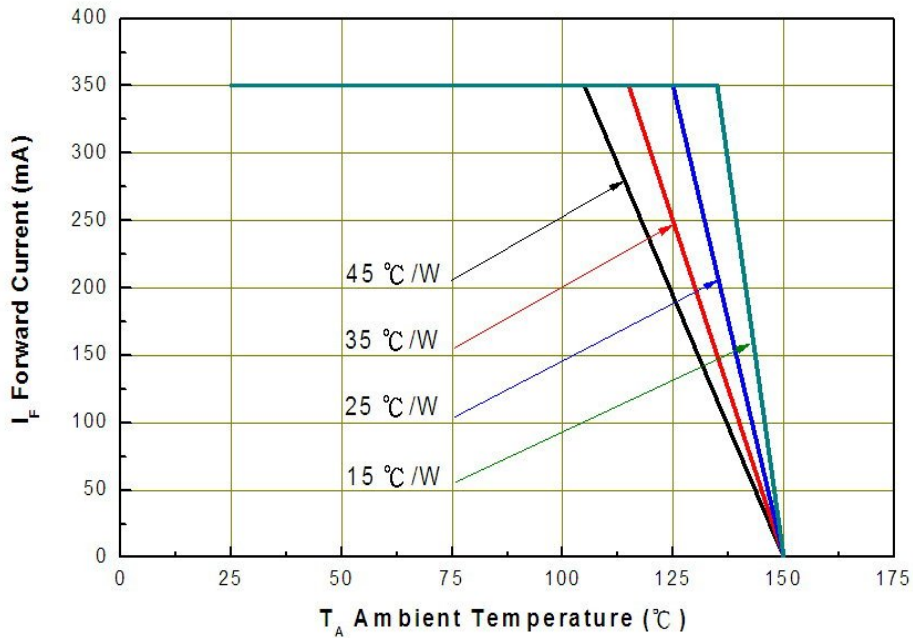

**Current Derating Curve for 350mA Drive Current  
Red, Amber, Yellow**

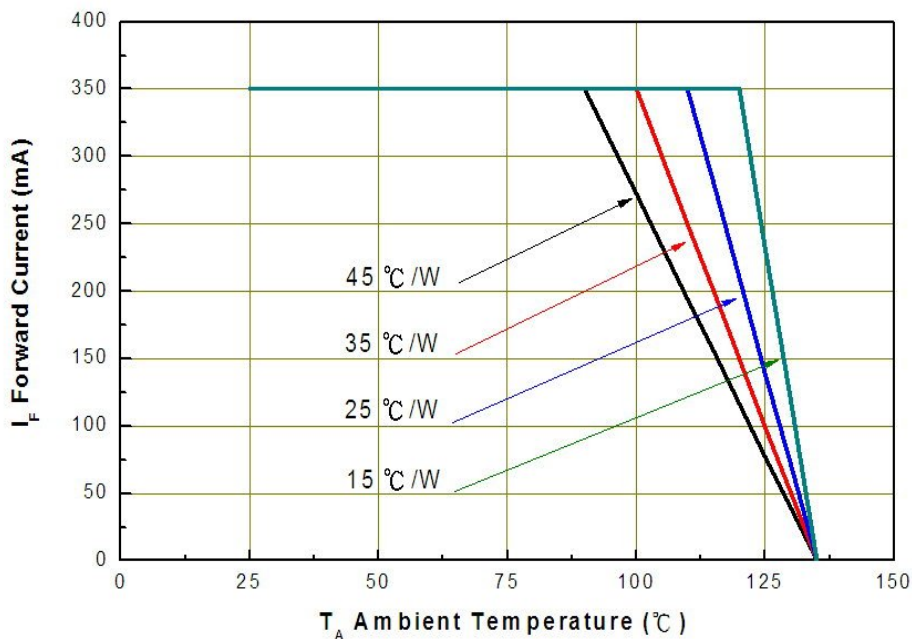

**Note:**

The current derating curves are depending on the thermal resistance between the junction to the soldering pad.

## Typical Radiation Patterns

### Shwo series: Typical Diagram Characteristics of Radiation for Cool-White, Neutral-White, Warm-White

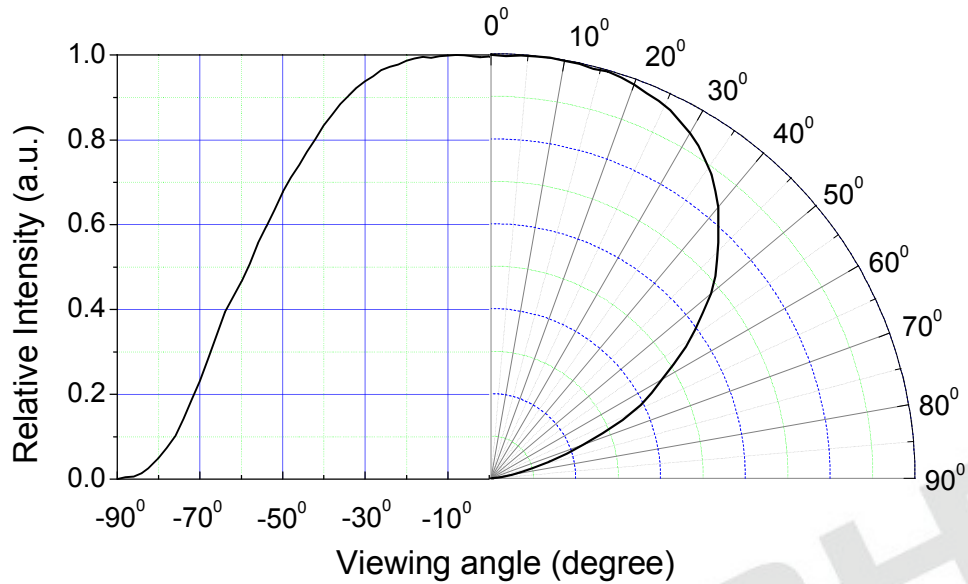

**Notes:**

1.  $2\theta_{1/2}$  is the off axis angle from lamp centerline where the luminous intensity is 1/2 of the peak value.
2. View angle tolerance is  $\pm 5^\circ$ .



## Emitter Tape Packaging

### Carrier Tape Dimensions as the following:

Order Qty.: > 2Kpcs, MPQ: min. 400pcs (incl. 400pcs / 800pcs) per reel.

Order Qty.: 1K ~ 2Kpcs, MPQ: min. 200pcs (incl. 300pcs / 400pcs / 800pcs) per reel.

Order Qty.: < 1Kpcs, MPQ: min. 100pcs (incl. 200pcs / 300pcs / 400pcs / 800pcs) per reel.

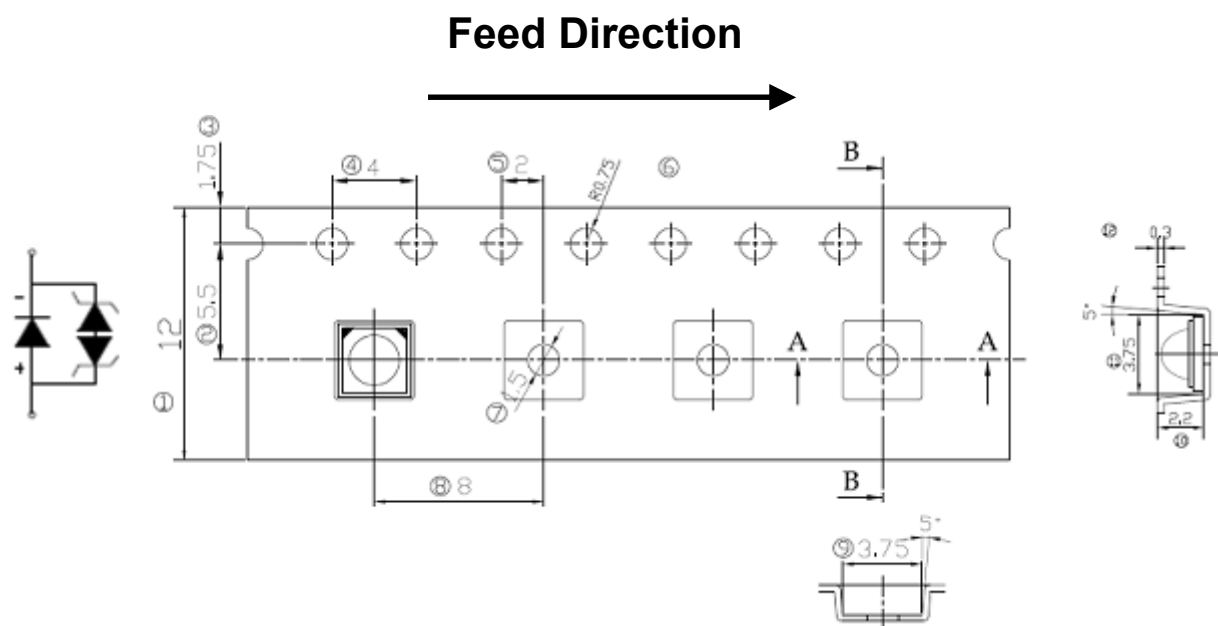

### Notes:

1. Dimensions are in millimeters.
2. Tolerances for fixed dimensions are  $\pm 0.1\text{mm}$ .

### Moisture Resistant Packaging

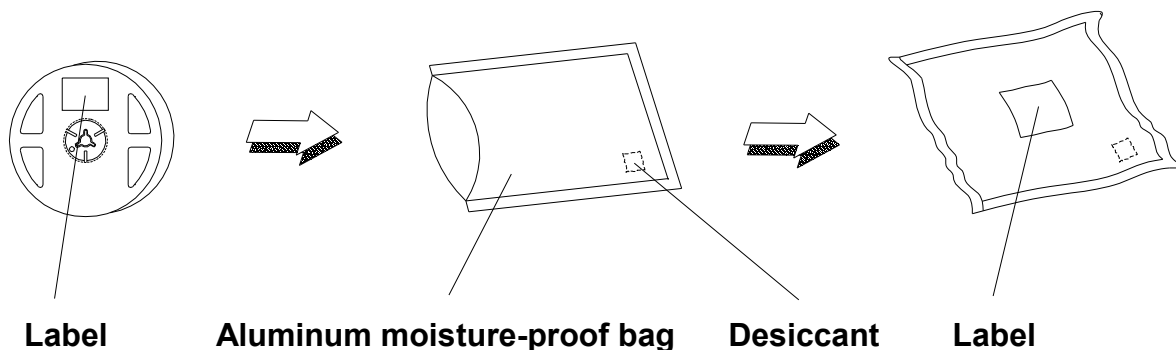

## Emitter Tape Packaging (Only for ELSW-F61R1-0PPNM-AR5R6 and ELSW-F61O1-0PPNM-AR3R4)

### Carrier Tape Dimensions as the following:

Order Qty.: > 2Kpcs, MPQ: min. 400pcs (incl. 400pcs / 800pcs) per reel.

Order Qty.: 1K ~ 2Kpcs, MPQ: min. 200pcs (incl. 300pcs / 400pcs / 800pcs) per reel.

Order Qty.: < 1Kpcs, MPQ: min. 100pcs (incl. 200pcs / 300pcs / 400pcs / 800pcs) per reel.

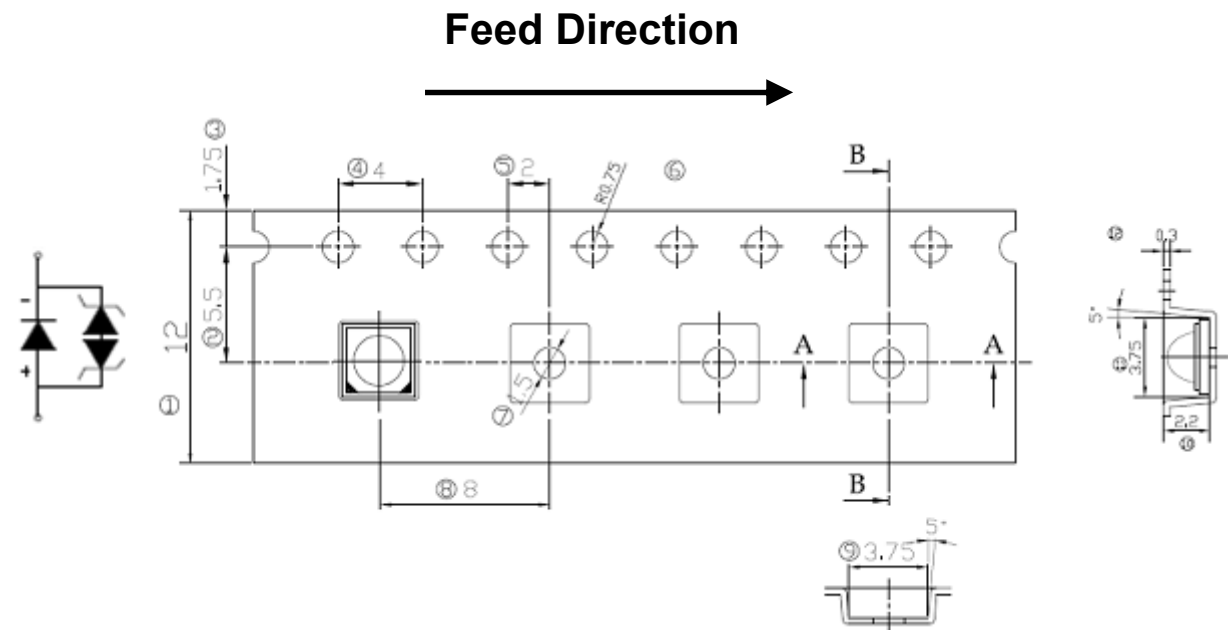

#### Notes:

3. Dimensions are in millimeters.
4. Tolerances for fixed dimensions are  $\pm 0.1\text{mm}$ .

### Moisture Resistant Packaging

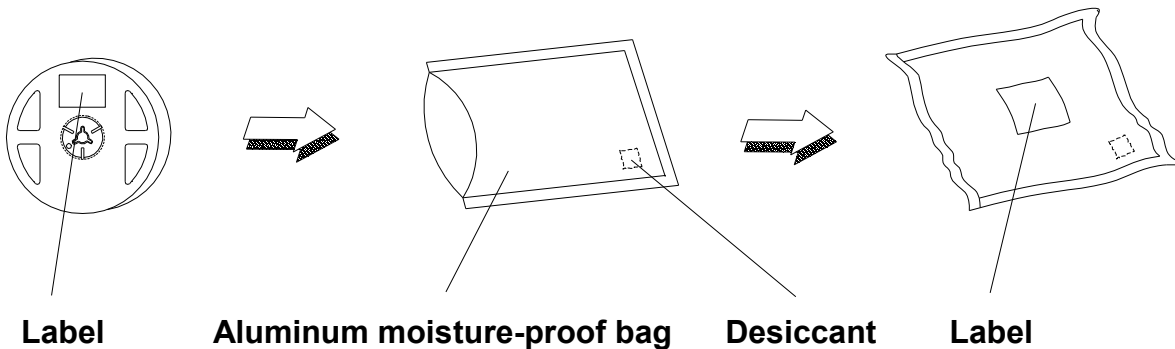

## Emitter Reel Packaging

### Reel Dimensions

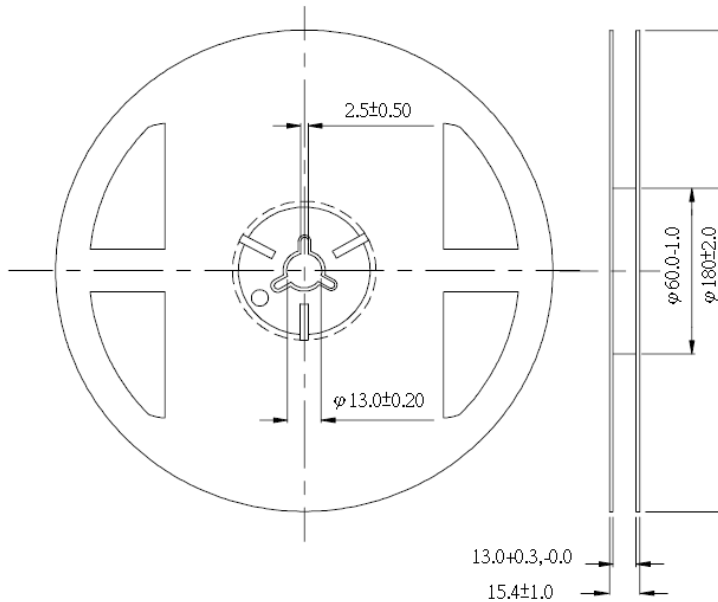

#### Notes:

1. Dimensions are in millimeters.
2. Tolerances unless mentioned are  $\pm 0.1$ mm.

## Product Labeling

### Label Explanation

CPN: Customer Specification (when required)

P/N : Everlight Production Number

QTY: Packing Quantity

CAT: Luminous Flux (Brightness) Bin

HUE: Color Bin

REF: Forward Voltage Bin

LOT No: Lot Number

MADE IN TAIWAN: Production Place



## Storage Conditions

- Before the package is opened. The LEDs should be stored at 30°C or less and 85%RH or less after being shipped from Everlight and the storage life limits are 1 year. The LEDs can be stored up to 3 years If in a sealed container with a nitrogen atmosphere and moisture absorbent material.
- After opening the package: The LED's floor life is 1 year under 30 or less and 60%RH or less. The LED should be soldered with 168hrs (7days) after opening the package. If unused LEDs remain, it should be stored in moisture proof packages.
- If the moisture absorbent material (silica gel) has faded away or the LEDs have exceeded the storage time, baking treatment should be performed using the following conditions. Baking treatment: 60±5 for 24 hours.

EVERLIGHT



Report No.: OA-2011-80004

Page 1 of 39

Issued: Sep. 05, 2012

## TEST REPORT

The following tested product(s) were submitted and identified by the vendor as:

Applicant : EVERLIGHT ELECTRONICS CO., LTD.  
Address of Applicant : No. 6-8, Zhonghua Rd., Shulin Dist., New Taipei City  
23860, Taiwan  
Testing Laboratory : SGS Taiwan Ltd., Optics Laboratory  
Testing Address : 33, Wu Chyuan Rd., New Taipei Industrial Park, New  
Taipei City, Taiwan 24886  
Product Name : Shwo Series LED Component  
Model / Serial Number : Shwo (3000 K)  
Manufacturer : EVERLIGHT ELECTRONICS CO., LTD.  
Rating : DC 350 mA, 1 W  
Test Standard/Method : IES LM-80-08 Approved Method: Measuring Lumen  
Maintenance of LED Light Sources  
Date of Issue : Sep. 05, 2012

The submitted products have been tested as requested and the following results were obtained, and the report, not applicable for lawsuit, refers only to the unit(s) submitted for test.

Test Results : -PLEASE SEE ATTACHED SHEETS-

Signed for and on behalf of  
SGS TAIWAN Ltd.

Calvin Tzou  
Technical Manager



Report No.: OA-2011-80004

Page 2 of 39

Issued: Sep. 05, 2012

**1 DATE OF RECEIPT OF SAMPLES**

Aug. 18, 2011

**2 DATE(S) OF PERFORMANCE OF THE TEST**

Sep. 14, 2011 ~ Jun. 22, 2012

**3 IDENTITY OF SAMPLES**

Quantity	Model	Serial Number
25	Shwo (3000 K)	# A01 - # A25 (25 °C)
25	Shwo (3000 K)	# B01 - # B25 (55 °C)
25	Shwo (3000 K)	# C01 - # C25 (85 °C)

**4 TEST ITEMS**

4.1 Data Summary of Lumen and Color Maintenance

Test results were concluded by different Case Temperatures (Ts).

4.2 Lumen Maintenance and Color Maintenance Test

Testing specifications by different case temperatures according to IES LM-80-08 Approved Method: Measuring Lumen Maintenance of LED Light Sources and client's requirements were implemented per the following items.

4.2.1 Total Luminous Flux ( $\Phi_v$ )

The test results of total luminous flux were implemented referring to Clause 2 PROPERTIES OF LEDS & Clause 6 MEASUREMENT OF LUMINOUS FLUX of CIE 127: 2007 2nd edition MRASUREMENT OF LEDS and IES LM-80-08 Approved Method: Measuring Lumen Maintenance of LED Light Sources, when the UUTs were powered with constant current of  $I_F$ .

4.2.2 Correlated Color Temperature (CCT), CIE Color Coordinate (CIE<sub>x</sub>, CIE<sub>y</sub>) & Chromaticity Shift ( $\Delta u'v'$ )

The test results of correlated color temperature were implemented referring to CIE 127:2007 2nd edition MRASUREMENT OF LEDS, CIE 15: 2004 COLORIMETRY.

The test results of color coordinate were implemented referring to CIE 127: 2007 2nd edition MRASUREMENT OF LEDS, CIE 15:2004 COLORIMETRY.



Report No.: OA-2011-80004

Page 3 of 39

Issued: Sep. 05, 2012

## 5 TEST CONDITIONS

### Main Test Equipment:

Name	Brand	Model	Traceability
Spectroradiometer	Labsphere	CDS 2100	NIST
Standard Light Source	Labsphere	SCL-600	NIST
Source Meter	Keithley	2400	NMI
Digital Multimeter	Agilent	U1242A	NMI

### Environmental Conditions:

Temperature: (25 ± 1) °C  
Relative Humidity: < 65 % RH

### UUT Conditions:

Drive Current: DC 350 mA  
Forward Voltage: DC 2.95 ~ 3.85 V  
Power Consumption: 1 W  
CCT: 3000 K  
Package Dimension: L 3.5 mm x W 3.5 mm x H 2.03 mm  
UUT Dimension: Φ 2.37 mm x H 1.5 mm  
Prior operation: 0 hr  
Total Operation Duration: 6000 hours  
Product Specs: See Appendix A

### Measurement Conditions:

Interval Time: 1000 hours  
Warm up Time: < 1 minute (initial)  
Relative measurement uncertainty: 2.8 % (95 % Confidence Level)





Report No.: OA-2011-80004

Page 4 of 39

Issued: Sep. 05, 2012

## 6 TEST RESULTS

### 6.1 Data Summary of Lumen and Color Maintenance

Temp.	Initial(0hrs)		Luminous Maintenance (%)					
	TLF(lm)	V <sub>F</sub> (V)	1000 hrs	2000 hrs	3000 hrs	4000 hrs	5000 hrs	6000 hrs
25°C Avg.	68.10	3.31	102.7%	100.3%	100.1%	99.8%	99.2%	98.5%
55°C Avg.	67.26	3.34	102.5%	100.1%	100.1%	99.9%	99.2%	98.0%
85°C Avg.	67.94	3.31	102.4%	100.2%	99.3%	98.8%	97.8%	96.2%

Temp.	Initial(0hrs)			Chromaticity Shift ( $\Delta u'v'$ )					
	CIE <sub>x</sub>	CIE <sub>y</sub>	CCT	1000 hrs	2000 hrs	3000 hrs	4000 hrs	5000 hrs	6000 hrs
25°C Avg.	0.4311	0.3959	3033	0.0006	0.0005	0.0003	0.0007	0.0020	0.0008
55°C Avg.	0.4311	0.3946	3019	0.0006	0.0005	0.0004	0.0004	0.0016	0.0007
85°C Avg.	0.4316	0.3957	3021	0.0013	0.0012	0.0013	0.0014	0.0026	0.0015



## Lumen maintenance life projection

Table 1: Report at each LM-80 Test Condition

Description of LED Light Source Tested (manufacturer, model, catalog number)		Test Condition 1 - 25°C Case Temp		Test Condition 2 - 55°C Case Temp		Test Condition 3 - 85°C Case Temp	
Sample size	20	Sample size	20	Sample size	20	Sample size	20
Number of failures	0	Number of failures	0	Number of failures	0	Number of failures	0
DUT drive current used in the test (mA)	20	DUT drive current used in the test (mA)	20	DUT drive current used in the test (mA)	20	DUT drive current used in the test (mA)	20
Test duration (hours)	6,000	Test duration (hours)	6,000	Test duration (hours)	6,000	Test duration (hours)	6,000
Test duration used for projection (hour to hour)	1,000 - 6,000	Test duration used for projection (hour to hour)	1,000 - 6,000	Test duration used for projection (hour to hour)	1,000 - 6,000	Test duration used for projection (hour to hour)	1,000 - 6,000
Tested case temperature (°C)	25	Tested case temperature (°C)	55	Tested case temperature (°C)	85	Tested case temperature (°C)	85
$\alpha$	6.996E-06	$\alpha$	7.245E-06	$\alpha$	1.114E-05	$\alpha$	1.114E-05
B	1.026	B	1.025	B	1.030	B	1.030
Calculated L70(6k) (hours)	55,000	Calculated L70(6k) (hours)	53,000	Calculated L70(6k) (hours)	35,000	Calculated L70(6k) (hours)	35,000
Reported L70(6k) (hours)	>36000	Reported L70(6k) (hours)	>36000	Reported L70(6k) (hours)	35,000	Reported L70(6k) (hours)	35,000

## Revision History

Current version: 01/14/2014  
Device No: DHE-0001156  
Version. 16

Page	Subjects (major change in previous version)	Date of change
6	Change the PN brightness level.	6/14/10
15	Change the viewing angle.	6/14/10
16	In the mechanical dimension, the polarity is changed.	6/14/10
17	In the pad configuration, the polarity is changed.	6/14/10
3	Change the Product Nomenclature.	8/26/10
4	Change the Absolute Ratings	8/26/10
6-7	Change the PN brightness level.	8/26/10
5	Change the PN brightness level.	1/12/11
7、 8、 31、 35	Add new PN, radiation patterns and storage conditions.	4/28/11
9、 22、 23	Add new P/N, Pad Configuration and Mechanical Dimension for ELSW-F61R1-0PPNM-AR5R6 and ELSW-F61O1-0PPNM-AR3R4.	5/3/11
6、 7、 8、 16、 18	Add new PN, Modify Forward Voltage Bins and Optical Characteristics of white LED series.	6/17/11
9、 10、 37	Add new PN and Modify Carrier Tape Dimensions & Note.	09/07/11
35、 36	Modify the minimum amount of packaging	10/28/11
6	Add new PN	11/22/11
8	Add new PN	10/30/12
1、 38~42	Add LM80 report	07/16/13
5、 10	Add new PN	08/26/13
37、 38	Add Tape Packaging for ELSW-*0PP* Series and modify Carrier Tape Dimensions max reel: 800pcs	01/14/2014