

Verpackt in Gurtverpackung
 Tape on Reel Packaging
 Verpackungseinheit: 500 Stück
 Packaging unit: 500 pcs

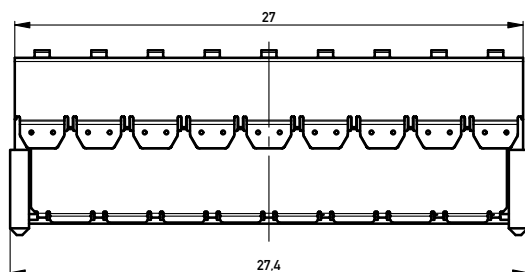

Abspulrichtung - Reel off Direction

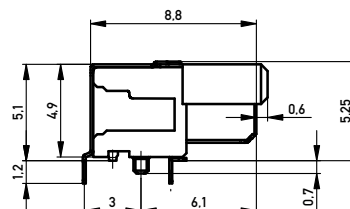
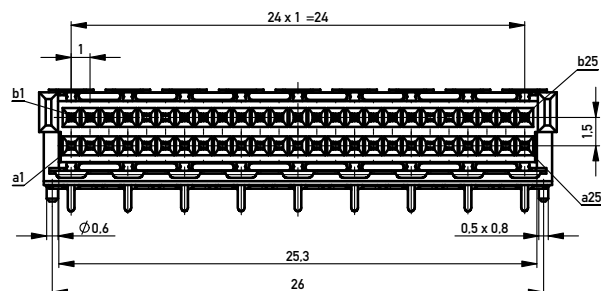
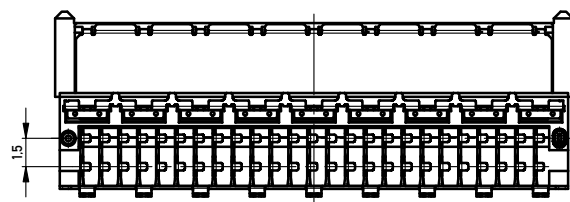
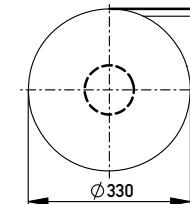
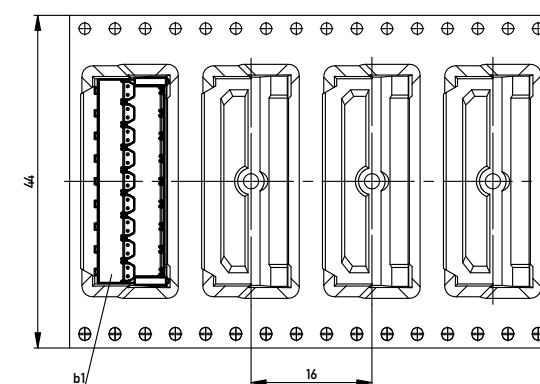

Leiterplatten-Layout Vorschlag / PCB-Layout Proposal

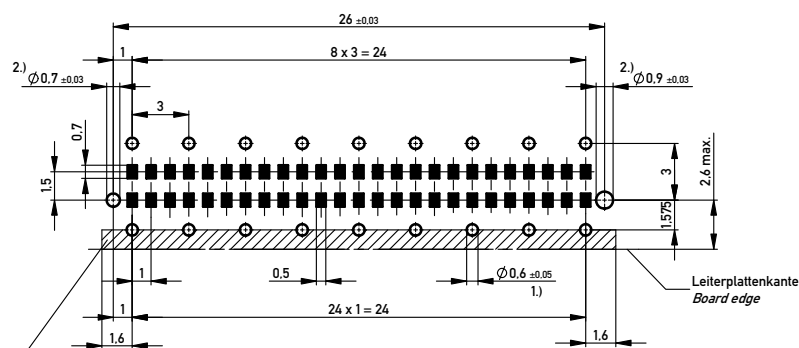

Schirmblechaufgefläche berücksichtigen.
 keine Durchkontaktierungen oder Leitungen möglich!
 Consider shielding contact area, no vias or traces possible!

- 1.) Fertiglochdurchmesser / Finished Via diameter
- 2.) Durchmesser des Bohrers / Drill tool

Anforderungsstufe 1
 Performance Level 1

Kontaktbereich vergoldet
 Mating Area gold plating

Anschlussbereich verzinkt 4-6 µm
 Terminal Area 4-6 µm tin plating

Koplanarität der Anschlüsse ≤ 0.1 mm
 Coplanarity Area of Termination ≤ 0.1 mm

Information:		Tolerances		Scale	5:1
All rights reserved. Only for Information. To ensure that this is the latest version of this drawing, please contact one of the ERNI companies before using.		Subject to modification without prior notice. Drawing will not be updated.		Designation	
		ERNI www.ERNI.com		Federl. 90° SMDTHR 50p. BM EMV Female 90° SMDTHR 50co. BM EMV	
e	15.04.2013			374720	
Index	Date			I A2	
				Class	MSPEED

Copyright by ERNI GmbH
 Proprietary notice pursuant to ISO 16949 to be observed