

High Efficiency Li-Ion Battery Charger

DESCRIPTION

The TS55001 is a DC/DC synchronous switching Li-ion Battery Charger with fully integrated power switches, internal compensation, and full fault protection. The switching frequency of 1MHz enables the use of small filter components, resulting in smaller board space and reduced BOM costs.

The regulation in Full Charge mode is Constant-Current (CC). Once termination voltage is reached, the regulator operates in voltage mode. When the regulator is disabled (EN is low), the device draws 10uA quiescent current.

The TS55001 includes supervisory reporting through the nFLT (Inverted Fault) open drain output to interface other components in the system. Device programming is achieved by an I²C interface through SCL and SDA pins.

APPLICATIONS

- Portable battery chargers
- Smart Phones
- Laptops
- Tablets / eReaders

FEATURES

- V_{BAT} reverse current blocking
- Programmable temperature-compensated termination voltage with +/- 1% tolerance
- Up to 1.5A of continuous output current in Full Charge Constant-Current (CC) mode
- User programmable charging current
- High efficiency – up to 92% at typical load
- Current mode PWM control in constant voltage
- Supervisor for V_{BAT} reported at the nFLT pin
- Input supply under-voltage lockout
- Full protection for V_{BAT} over-current, over-temp, over-voltage, and charging timeout
- Charge status indication
- I²C program interface with EEPROM registers

SUMMARY SPECIFICATIONS

- Wide input voltage range: V_{BAT} + 0.3V (3.5V min) to 7.2V
- Packaged in a 16pin QFN (4x4)

TYPICAL APPLICATION

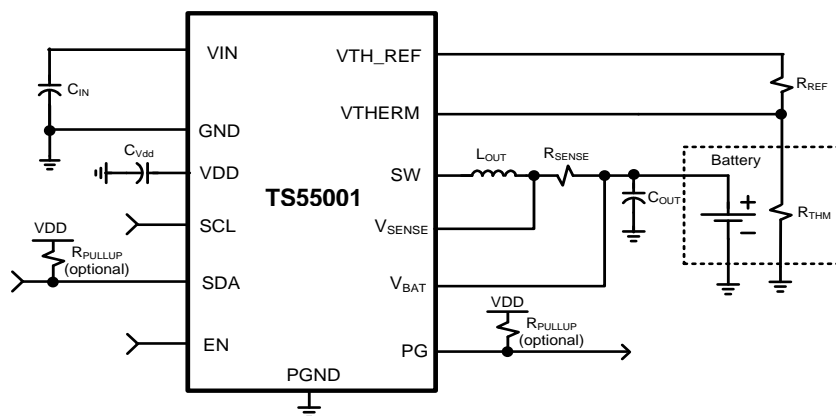

PINOUT

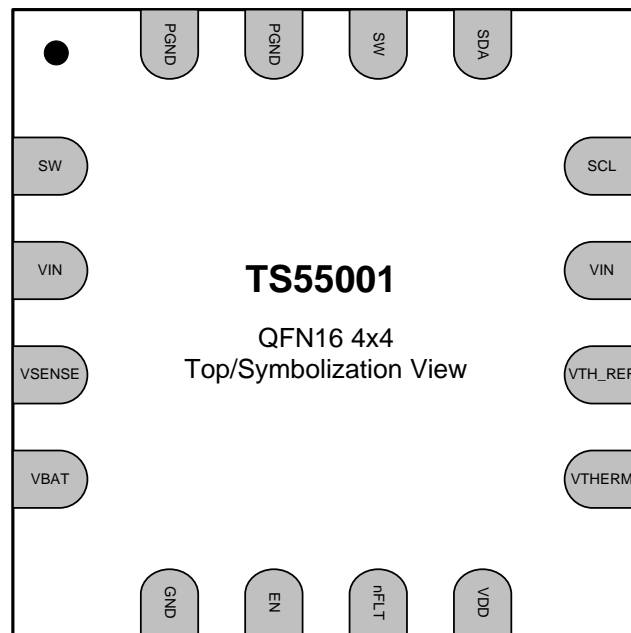

Figure 1b: Package Pinout Diagram

PIN DESCRIPTION

Pin Symbol	Pin #	Function	Description
SW	1	Switching Voltage Node	Connected to 4.7uH (typical) inductor
VIN	2	Input Voltage	Input voltage
VSENSE	3	Current Sense Positive Input	Positive input for the current loop
VBAT	4	Battery Input	Regulator Feedback Input
GND	5	GND	Primary ground for the majority of the device except the low-side power FET.
EN	6	Enable Input	Above 2.2V the device is enabled. GND the pin to disable the device. Includes internal pull-up.
nFLT	7	Inverted Fault	Open-drain output.
VDD	8	Internal 3.3V Supply Output	Connected to 100nF capacitor to GND
VTHERM	9	Battery Temperature Sensor Minus Node	Minus node for the thermistor which is located in close proximity to the battery.
VTH_REF	10	Battery Temperature Sensor Positive Node	Positive node for the thermistor which is located in close proximity to the battery
VIN	11	Input Voltage	Input voltage
SCL	12	Clock Input	I ² C clock input.
SDA	13	Data Input/Output	I ² C data open-drain output.
SW	14	Switching Voltage Node	Connected to 4.7uH (typical) inductor
PGND	15	Power GND	GND supply for internal low-side FET/integrated diode
PGND	16	Power GND	GND supply for internal low-side FET/integrated diode

FUNCTIONAL BLOCK DIAGRAM

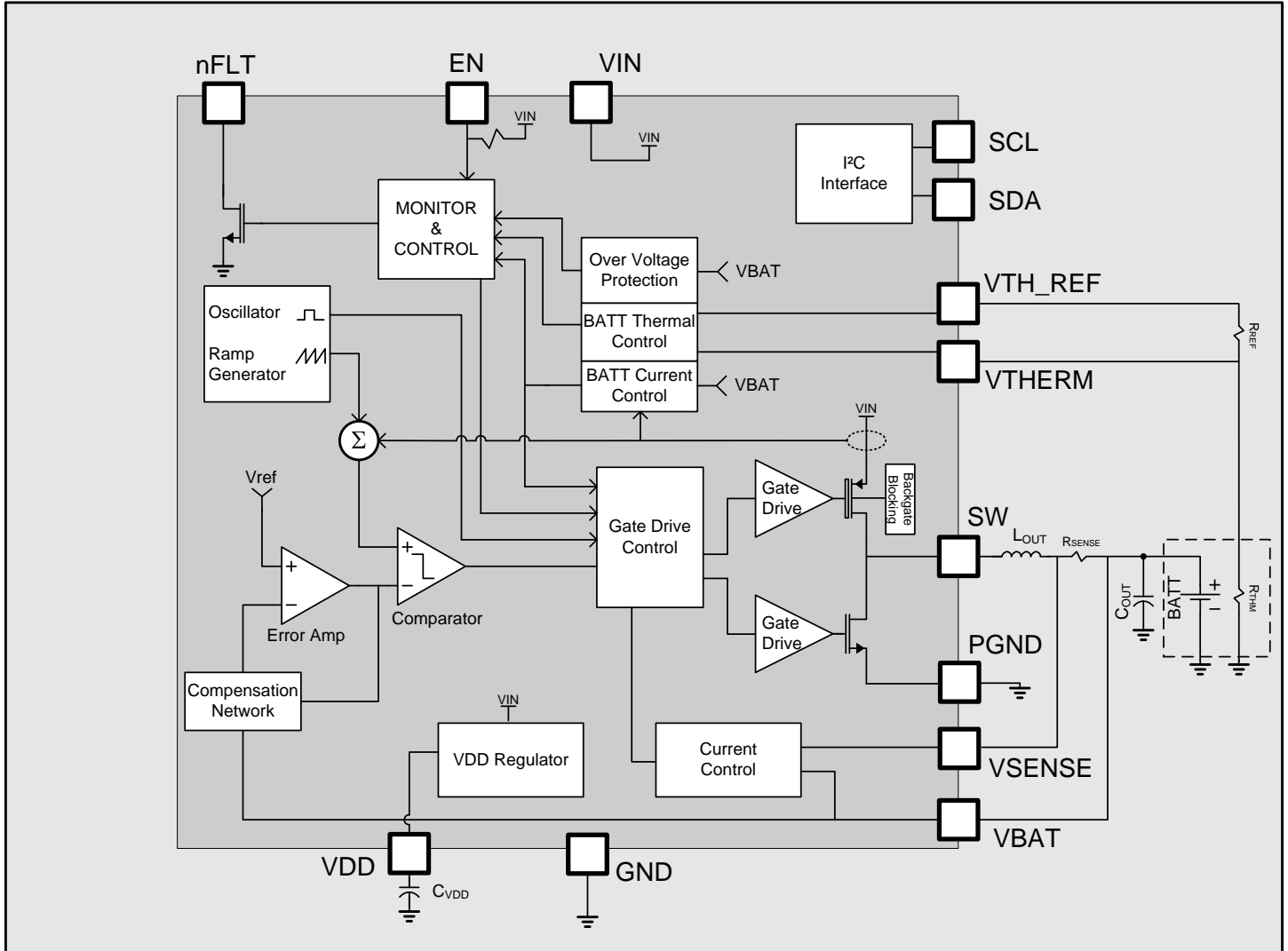

Figure 2: TS55001 Block Diagram

ABSOLUTE MAXIMUM RATINGS

Over operating free-air temperature range unless otherwise noted^(1,2,3)

Parameter	Range	Unit
VIN, EN, nFLT, SCL, SDA, VTHERM, VTH_REF, VBAT, VSENSE	-0.3 to 8	V
SW	-1 to 8.8	V
VDD	-0.3 to 3.6	V
Operating Junction Temperature Range, T _J	-40 to 125	°C
Storage Temperature Range, T _{STG}	-65 to 150	°C
Electrostatic Discharge – Human Body Model	±2k	V
Electrostatic Discharge – Machine Model	+/-200	V
Lead Temperature (soldering, 10 seconds)	260	°C

(1) Stresses beyond those listed under “absolute maximum ratings” may cause permanent damage to the device. These are stress ratings only and functional operation of the device at these or any other conditions beyond those indicated under “recommended operating conditions” is not implied. Exposure to absolute-maximum-rated conditions for extended periods may affect device reliability.

(2) All voltage values are with respect to network ground terminal.

(3) ESD testing is performed according to the respective JESD22 JEDEC standard.

THERMAL CHARACTERISTICS

Symbol	Parameter	Value	Unit
θ _{JA}	Thermal Resistance Junction to Air (Note 1)	50	°C/W

Note 1: Assumes 4x4 QFN-16 in 1 in² area of 2 oz copper and 25°C ambient temperature.

RECOMMENDED OPERATING CONDITIONS

Symbol	Parameter	Min	Typ	Max	Unit
VIN	Input Operating Voltage	V _{BAT} + 0.3, (3.5V min)	5.3	7.2	V
R _{SENSE}	Sense Resistor		50		mΩ
L _{OUT}	Output Filter Inductor Typical Value (Note 1)		4.7		uH
C _{OUT}	Output Filter Capacitor Typical Value (Note 2)		4.7		uF
C _{OUT-ESR}	Output Filter Capacitor ESR			100	mΩ
C _{IN}	Input Supply Bypass Capacitor Value (Note 3)	3.3	10		uF
C _{VDD}	VDD Supply Bypass Capacitor Value (Note 2)	70	100	130	nF
T _A	Operating Free Air Temperature	-40		85	°C
T _J	Operating Junction Temperature	-40		125	°C

Note 1: For best performance, an inductor with a saturation current rating higher than the maximum V_{BAT} load requirement plus the inductor current ripple.

Note 2: For best performance, a low ESR ceramic capacitor should be used.

Note 3: For best performance, a low ESR ceramic capacitor should be used. If C_{IN} is not a low ESR ceramic capacitor, a 0.1uF ceramic capacitor should be added in parallel to C_{IN}.

CHARACTERISTICS

 Electrical Characteristics, $T_j = -40\text{C}$ to 125C , $V_{IN} = 5.3\text{V}$ (unless otherwise noted)

Symbol	Parameter	Condition	Min	Typ	Max	Unit
VIN Supply Voltage						
V_{IN}	Voltage Input		$V_{BAT} + 0.3$, (3.5V min)	5.3	7.2	V
$I_{CC-NORM}$	Quiescent current Normal Mode	$I_{LOAD} = 0\text{A}$, no switching		3		mA
$I_{CC-DISABLE}$	Quiescent current Disable Mode	$EN = 0\text{V}$		10	50	μA
VBAT Leakage						
$I_{BAT-LEAK}$	Leakage Current From Batt	$EN = 0\text{V}$, $V_{BAT} = 4.1\text{V}$			10	μA
$I_{BAT-BACK}$	Reverse Current	$V_{BAT} > V_{IN}$, $V_{BAT} = 4.1\text{V}$, $T_j < 85\text{C}$			10	μA
VIN Under-Voltage Lockout						
V_{IN-UV}	Input Supply Under-Voltage Threshold	V_{IN} Increasing		3.15		V
$V_{IN-UV-HYST}$	Input Supply Under-Voltage Threshold Hysteresis		100	200		mV
OSC						
F_{OSC}	Oscillator Frequency		0.9	1	1.1	MHz
nFLT Open Drain Output						
$I_{OH-nFLT}$	High-Level Output Leakage	$V_{nFLT} = 5.3\text{V}$		0.1		μA
$V_{OL-nFLT}$	Low-Level Output Voltage	$I_{nFLT} = -1\text{mA}$			0.4	V
EN/SCL/SDA Input Voltage Thresholds						
V_{IH}	High Level Input Voltage		2.2			V
V_{IL}	Low Level Input Voltage				0.8	V
V_{HYST}	Input Hysteresis			200		mV
I_{IN-EN}	Input Leakage	$V_{EN}=VIN$		0.1		μA
		$V_{EN}=0\text{V}$		-2.0		μA
I_{IN-SCL}	Input Leakage	$V_{SCL}=VIN$		55		μA
		$V_{SCL}=0\text{V}$		-0.1		μA
I_{IN-SDA}	Input Leakage	$V_{SDA}=VIN$		0.1		μA
		$V_{SDA}=0\text{V}$		-0.1		μA
V_{OL-SDA}	Low-Level Output Voltage	$I_{SDA} = -1\text{mA}$			0.4	V
Thermal Shutdown						
TSD	Thermal Shutdown Junction Temperature		150	170		$^{\circ}\text{C}$
TSD_{HYST}	TSD Hysteresis			10		$^{\circ}\text{C}$
Pre-Charge End						
V_{PreChg}	Pre-Charge Voltage Threshold		2.9	3.0	3.1	V
$V_{PC-HYST}$	Pre-Charge Voltage Hysteresis			70		mV
Charge Restart						
$V_{ReStart}$	Voltage below termination for charging restart			100		mV

CHARGER CHARACTERISTICS

 Electrical Characteristics, $T_j = -40\text{C}$ to 125C , $V_{IN} = 5.3\text{V}$ (unless otherwise noted)

Symbol	Parameter	Condition	Min	Typ	Max	Unit
Charging Regulator: L=4.7uH and C=4.7uF						
I_{BAT-FC}	Output Current Limit in Full-Charge Mode	$I_{BAT} = 1.5\text{A}$	$I_{BAT} - 10\%$	I_{BAT}	$I_{BAT} + 10\%$	A
V_{BAT-TO}	Termination Voltage Tolerance in Top-Off Mode	$I_{BAT} = 0.1\text{C}$, $0\text{C} < T_j < 85\text{C}$	$V_{BAT} - 1\%$	V_{BAT}	$V_{BAT} + 1\%$	V
t_{TO}	Top-Off Mode Time Out		0		120	min
t_{FC}	Full-Charge Timer		200		1400	min
t_{acc}	Timer Accuracy		-10%		+10%	
$R_{DS(on)}$	High Side Switch On Resistance	$I_{SW} = -1\text{A}$, $T_j = 25\text{C}$		200		m Ω
	Low Side Switch On Resistance	$I_{SW} = 1\text{A}$, $T_j = 25\text{C}$		250		m Ω
I_{BAT}	Max Output Current			1.5		A
I_{OCD}	Over-Current Detect	HS switch current		2.5		A
V_{BAT-OV}	V_{BAT} Over-Voltage Threshold		101% V_{BAT}	102% V_{BAT}	103% V_{BAT}	
$DUTY_{MAX}$	Max Duty Cycle			98		%

I²C INTERFACE TIMING REQUIREMENTS

 Electrical Characteristics, $T_j = -40\text{C}$ to 125C , $V_{IN} = 5.3\text{V}$ (unless otherwise noted)

Symbol	Parameter	Standard Mode		Fast Mode ⁽¹⁾		Unit
		Min	Max	Min	Max	
f_{scl}	I ² C clock frequency	0	100	0	400	kHz
t_{sch}	I ² C clock high time	4		0.6		μs
t_{scl}	I ² C clock low time	4.7		1.3		μs
$t_{sp}^{(2)}$	I ² C tolerable spike time	0	50	0	50	ns
t_{sds}	I ² C serial data setup time	250		250		ns
t_{sdh}	I ² C serial data hold time	0		0		μs
$t_{icr}^{(2)}$	I ² C input rise time		1000		300	ns
$t_{icf}^{(2)}$	I ² C input fall time		300		300	ns
$t_{ocf}^{(2)}$	I ² C output fall time; 10 pF to 400 pF bus		300		300	ns
t_{buf}	I ² C bus free time between Stop and Start	4.7		1.3		μs
t_{sts}	I ² C Start or repeated Start condition setup time	4.7		0.6		μs
t_{sth}	I ² C Start or repeated Start condition hold time	4		0.6		μs
$t_{sps}^{(2)}$	I ² C Stop condition setup time	4		0.6		μs

 (1) The I²C interface will operate in either standard or fast mode.

(2) Parameters not tested in production.

THERMISTOR CHARACTERISTICS

 Electrical Characteristics, $T_J = -40\text{C}$ to 125C , $V_{IN} = 5.3\text{V}$ (unless otherwise noted)

Symbol	Parameter	Condition	Min	Typ	Max	Unit
V_{VTH_REF}	VTH_REF output voltage	$I_{VT_REF} = 2\mu\text{A}-100\mu\text{A}$		1.22		V
10KΩ Temperature Thresholds - $\beta=3434\text{K}$						
0°C	0°C Vtherm Threshold (0°C)	Decreasing Temperature		75.6		%VTH_REF
0°C_{HYST}	0°C Vtherm Threshold with Hysteresis (10°C)	Increasing Temperature		66.5		%VTH_REF
10°C	10°C Vtherm Threshold (10°C)	Decreasing Temperature		66.2		%VTH_REF
10°C_{HYST}	10°C Vtherm Threshold with Hysteresis (11°C)	Increasing Temperature		65.4		%VTH_REF
45°C	45°C Vtherm Threshold (45°C)	Increasing Temperature		34.5		%VTH_REF
45°C_{HYST}	45°C Vtherm Threshold with Hysteresis (44°C)	Decreasing Temperature		35.3		%VTH_REF
50°C	50°C Vtherm Threshold (50°C)	Increasing Temperature		30.8		%VTH_REF
50°C_{HYST}	50°C Vtherm Threshold with Hysteresis (49°C)	Decreasing Temperature		31.5		%VTH_REF
60°C	60°C Vtherm Threshold (60°C)	Increasing Temperature		24.9		%VTH_REF
60°C_{HYST}	60°C Vtherm Threshold with Hysteresis (50°C)	Decreasing Temperature		30.8		%VTH_REF
100KΩ Temperature Thresholds - $\beta=4311\text{K}$						
0°C	0°C Vtherm Threshold (0°C)	Decreasing Temperature		80.5		%VTH_REF
0°C_{HYST}	0°C Vtherm Threshold with Hysteresis (10°C)	Increasing Temperature		69.8		%VTH_REF
10°C	10°C Vtherm Threshold (10°C)	Decreasing Temperature		69.8		%VTH_REF
10°C_{HYST}	10°C Vtherm Threshold with Hysteresis (11°C)	Increasing Temperature		68.6		%VTH_REF
45°C	45°C Vtherm Threshold (45°C)	Increasing Temperature		31.3		%VTH_REF
45°C_{HYST}	45°C Vtherm Threshold with Hysteresis (44°C)	Decreasing Temperature		32.3		%VTH_REF
50°C	50°C Vtherm Threshold (50°C)	Increasing Temperature		27.0		%VTH_REF
50°C_{HYST}	50°C Vtherm Threshold with Hysteresis (49°C)	Decreasing Temperature		27.8		%VTH_REF
60°C	60°C Vtherm Threshold (60°C)	Increasing Temperature		19.4		%VTH_REF
60°C_{HYST}	60°C Vtherm Threshold with Hysteresis (50°C)	Decreasing Temperature		27.0		%VTH_REF

FUNCTIONAL DESCRIPTION

The TS55001 is a fully-integrated Li-Ion battery charger IC based on a highly-efficient switching topology. It includes configurability for termination voltage, charge current and a host of other variables to allow optimum charging conditions for a wide range of Li-Ion batteries. A 1 MHz internal switching frequency facilitates low-cost LC filter combinations.

When the battery voltage is below 3.0 volts, the device will enter a pre-charge state and apply a small, programmable charge current to safely charge the battery to a level for which full charge current can be applied. Once the full charge mode has been initiated, the regulation will be constant current (CC).

When the battery voltage has increased enough to go into maintenance mode, the PWM control loop will force a constant voltage across the battery. Once in constant voltage mode, current is monitored to determine when the battery is fully charged. This regulation voltage as well as the 1C charging current can be set to change based on battery temperature. There are 4 temperature ranges where these can be set independently, 0-10°C, 10-45°C, 45-50°C and 50-60°C. The 0°C and 60°C thresholds will stop charging and have 10 degrees of hysteresis. The intermediate points have 1 degree of hysteresis.

INTERNAL PROTECTION DETAILS

Internal Current Limit

The current through the inductor is sensed on a cycle by cycle basis and if current limit is reached, it will abbreviate the cycle. Current limit is always active when the regulator is enabled.

Thermal Shutdown

If the temperature of the die exceeds 170°C (typical), the SW outputs will tri-state to protect the device from damage. The nFLT and all other protection circuitry will stay active to inform the system of the failure mode. Once the device cools to 160°C (typical), the device will attempt to start up again. If the device reaches 170°C, the shutdown/restart sequence will repeat.

VIN Under-Voltage Lockout

The device is held in the off state until VIN reaches 3.15V. There is a 200mV hysteresis on this input, which requires the input to fall below 2.95V before the device will disable.

Battery Over-Voltage Protection

The TS55001 has a battery protection circuit designed to shutdown the charging profile if the battery voltage is greater than the termination voltage. The termination voltage can change based on user programming, so the protection threshold is set to 2% above the termination voltage. Shutting down the charging profile puts the TS55001 in a fault condition.

FAULT HANDLING

nFLT Pin Functionality

In the event of a battery over-voltage, the battery temperature being outside of the safe charging range or the full charge timer expiring, charging will stop, and the nFLT pin will be pulled low. When the fault condition is no longer present, the device will enter the INITIALIZE state, but the nFLT pin will remain low until register 0 is read. When the register 0 is read, the nFLT pin will go high until a new fault is detected.

Other Faults

When an open thermistor, thermal shut down, VIN under-voltage, or top off time-out are detected, charging will immediately stop and the corresponding bit in register 0 will be set. The device will enter the INITIALIZE state until the fault is no longer detected.

SERIAL INTERFACE

The TS55001 features an I²C slave interface which offers advanced control and diagnostic features. I²C operation offers configuration control for termination voltages, charge currents, and charge timeouts. This configurability allows for optimum charging conditions in a wide range of Li-Ion batteries. I²C operation also offers fault and warning indicators. Whenever a fault is detected, the associated status bit in the STATUS register is set and the nFLT pin is pulled low. Whenever a warning is detected, the associated status bit in the STATUS register is set, but the nFLT pin is not pulled low. Reading of the STATUS register resets the fault and warning status bits, and the nFLT pin is released after all fault status bits have been reset.

I²C SUBADDRESS DEFINITION

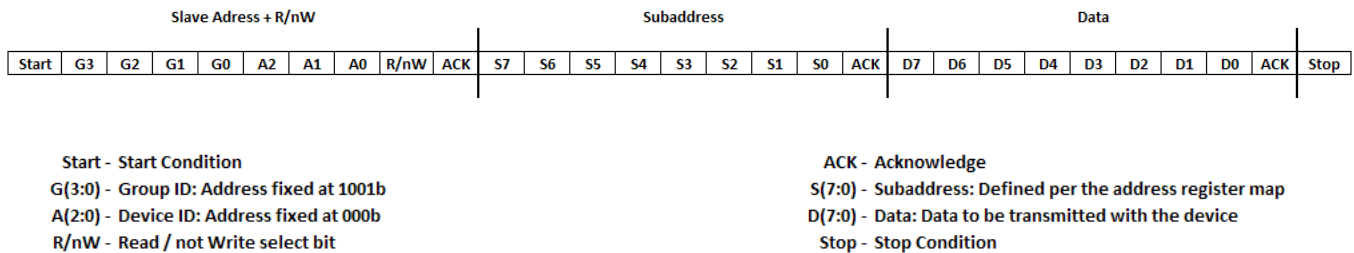

Figure 3: Sub-address in I²C Transmission

I²C BUS OPERATION

The TS55001 has a slave I²C interface that supports standard and fast mode data rates, auto-sequencing, and is compliant to I²C standard version 3.0.

I²C is a two-wire serial interface where the two lines are serial clock (SCL) and serial data (SDA). SDA must be connected to a positive supply through an external pull-up resistor. The devices communicating on this bus can drive the SDA line low or release it to high impedance. The device that initiates the I²C transaction becomes the master of the bus. Communication is initiated by the master sending a Start condition, a high-to-low transition on SDA, while the SCL line is high. After the Start condition, the device address byte is sent, most significant bit (MSB) first, including the data direction bit (R/nW). After receiving the valid address byte, the device responds with an acknowledge (ACK). An ACK is a low on SDA during the high of the ACK related clock pulse. On the I²C bus, during each clock pulse only one data bit is transferred. The data on the SDA line must remain stable during the high pulse of the clock period, as changes in the data line at this time are interpreted as Start or Stop control commands. A low-to-high transition on SDA while the SCL input is high, indicates a Stop condition and is sent by the master (see Figure 4).

Any number of data bytes can be transferred from the transmitter to receiver between the Start and the Stop conditions. Each byte of eight bits is followed by one ACK bit. The SDA line must be released by the transmitter before the receiver can send an ACK bit. The receiver that acknowledges must pull down the SDA line during the ACK clock pulse, so that the SDA line is stable low during the high pulse of the ACK-related clock period. When a slave receiver is addressed, it must generate an ACK after each byte is received. Similarly, the master must generate an ACK after each byte that it receives from the slave transmitter. To ensure proper operation, setup and hold times must be met. An end of data is signaled by the master receiver to the slave transmitter by not generating an acknowledge after the last byte has been clocked out of the slave. This is done by the master receiver by holding the SDA line high. The transmitter must then release the data line to enable the master to generate a Stop condition.

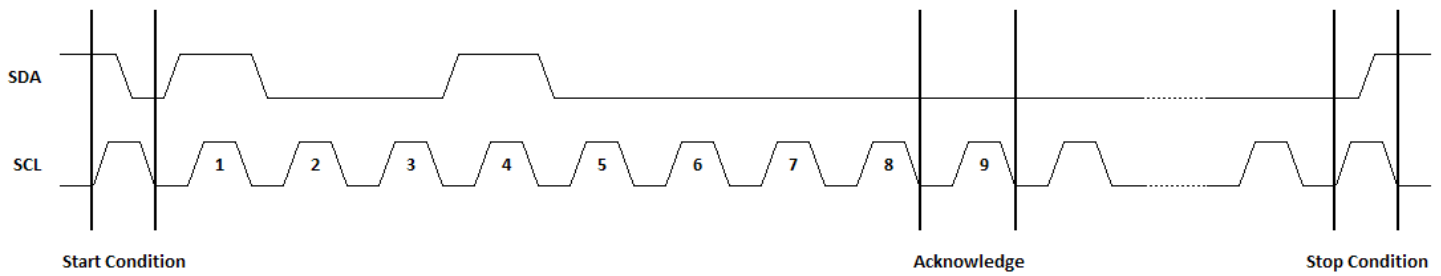
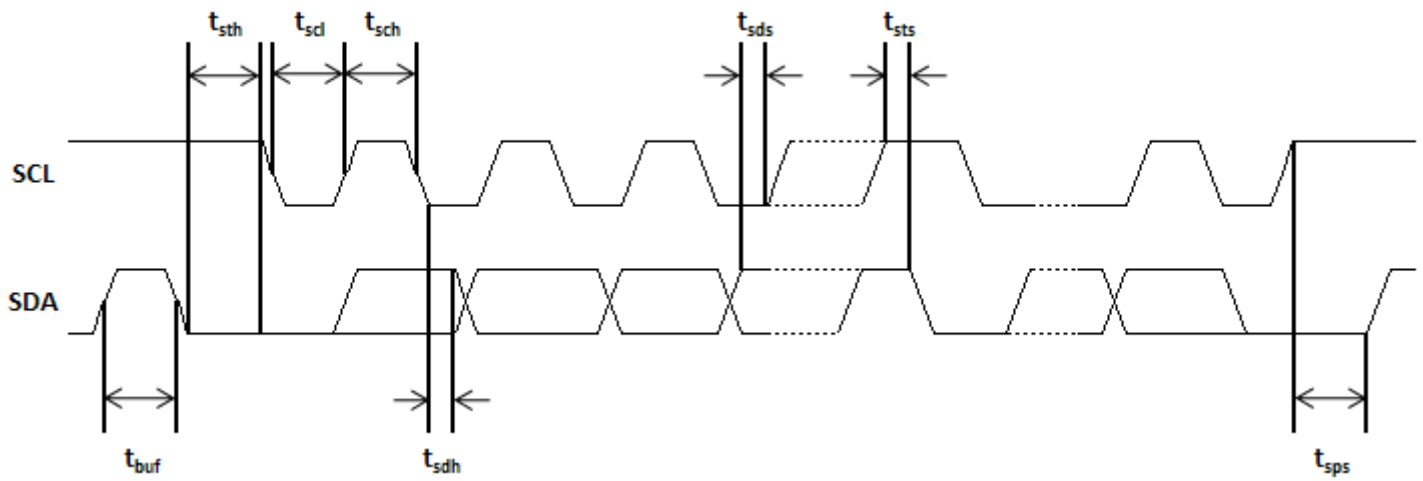
 Figure 4: I²C Start / Stop Protocol

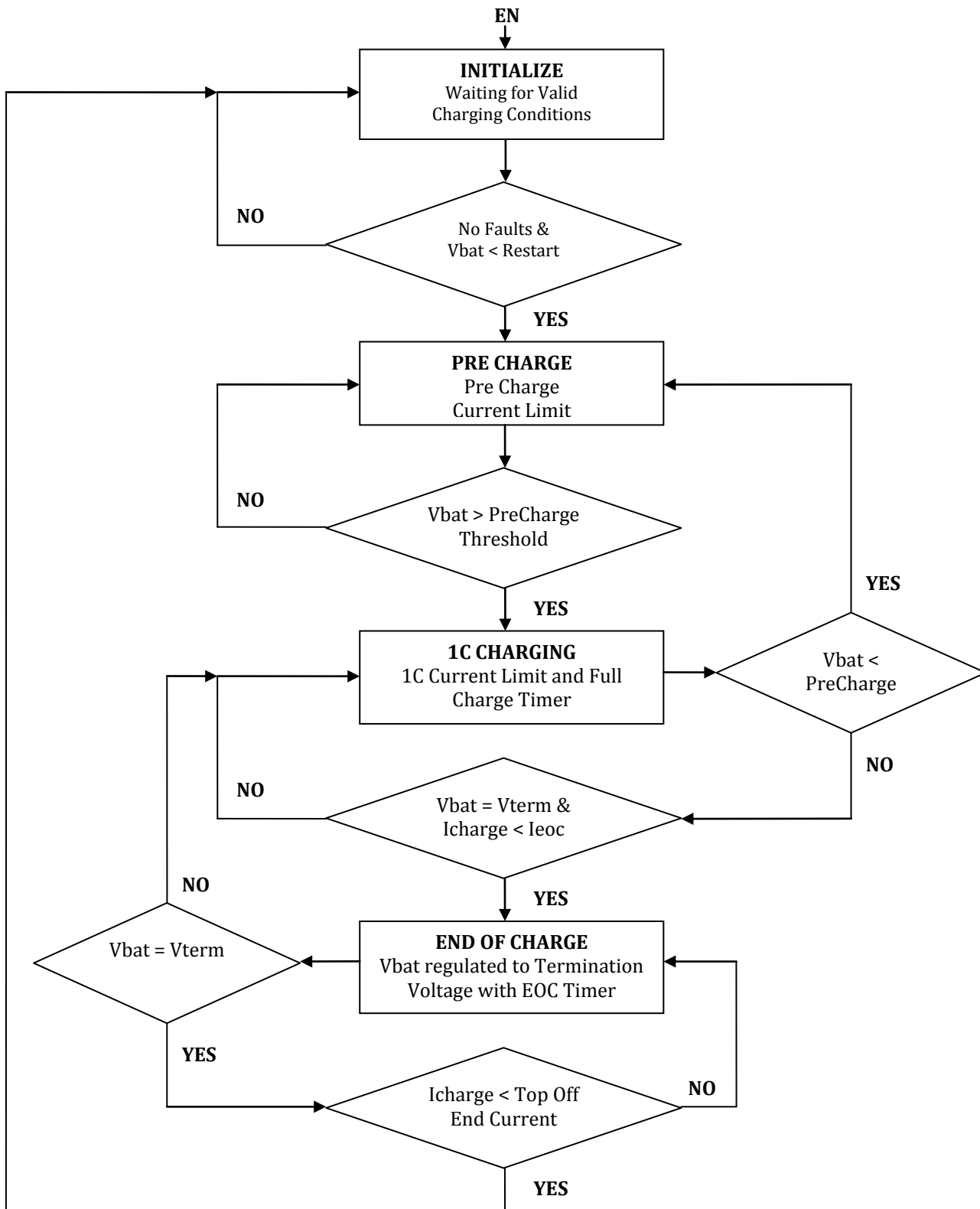
 Figure 5: I²C Data Transmission Timing

CHARGING STATE DIAGRAM

REGISTER DESCRIPTION (Device Address = 0x48)

REGISTER	ADDRESS (HEX)	NAME	DEFAULT	DESCRIPTION
0	00	STATUS	0x00	Status bit register
1	N/A	N/A	N/A	Register not implemented
2	02	CONFIG1 ⁽¹⁾	EEPROM	Configuration register
3	03	CONFIG2 ⁽¹⁾	EEPROM	Configuration register
4	04	CONFIG3 ⁽¹⁾	EEPROM	Configuration register
5	05	CONFIG4 ⁽¹⁾	EEPROM	Configuration register
6	06	CONFIG5 ⁽¹⁾	EEPROM	Configuration register
7-16	N/A	N/A	N/A	Registers not implemented
17	11	CONFIG_ENABLE	0x00	Enable configuration register access
18	12	EEPROM_CTRL ⁽¹⁾	0x00	EEPROM control register

(1) CONFIG and EEPROM_CTRL registers are only accessible when CONFIG_ENABLE register is written.

STATUS REGISTER (STATUS)

Address - 0x00h

DATA BIT	D7	D6	D5	D4	D3	D2	D1	D0
FIELD NAME	BATT_OV	1C_TO	TEMP_0C	TEMP_60C	TSD	TOP_TO	VIN_UV	TH_OPEN
READ/WRITE	R	R	R	R	R	R	R	R

FIELD NAME	BIT DEFINITION ⁽²⁾
BATT_OV	Battery over-voltage
1C_TO	Full charge timer has timed out
TEMP_0C	Thermistor indicates battery temperature < 0°C
TEMP_60C	Thermistor indicates battery temperature > 60°C
TSD	Thermal shutdown
TOP_TO	Top Off timer has timed out
VIN_UV	VIN under-voltage
TH_OPEN	Thermistor Open (battery not present)

(2) Faults are defined as BATT_OV, 1C_TO, TEMP_0C, and TEMP_60C. Warnings are defined as TSD, TOP_TO, VIN_UV, and TH_OPEN. Faults cause the nFLT pin to be pulled low, Warnings do not cause the nFLT pin to be pulled low. All status bits are cleared after register read access. nFLT pin will go high impedance (open drain output) after the status register has been read and all status bits have been reset.

CONFIGURATION REGISTER (CONFIG1)

Address - 0x02h

DATA BIT	D7	D6	D5	D4	D3	D2	D1	D0
FIELD NAME	PRE_CHRG[1:0]		V_TERM_0_10[2:0]		V_TERM_10_45[2:0]			
READ/WRITE	R/W	R/W	R/W	R/W	R/W	R/W	R/W	R/W

FIELD NAME	BIT DEFINITION
PRE_CHRG[1:0] ⁽¹⁾	Pre-Charging configuration 00 - 50 mA 01 - 100 mA 10 - 185 mA 11 - 370 mA
V_TERM_0_10[2:0] ⁽²⁾	Voltage Termination 0-10°C configuration 000 - 3.94 V 001 - 4.00 V 010 - 4.05 V 011 - 4.10 V 100 - 4.12 V 101 - 4.15 V 110 - 4.18 V 111 - Invalid Setting
V_TERM_10_45[2:0] ⁽²⁾	Voltage Termination 10-45°C configuration 000 - 3.94 V 001 - 4.00 V 010 - 4.05 V 011 - 4.10 V 100 - 4.12 V 101 - 4.15 V 110 - 4.18 V 111 - Invalid Setting

(1) PRE_CHRG Note: Maximum output current when $V_{BAT} < 3.0$ V.

(2) V_TERM Note: Unique settings available for battery temperatures 0-10°C, 10-45°C, 45-50°C, and 50-60°C. For <0°C and >60°C, charging is disabled and a fault is set.

CONFIGURATION REGISTER (CONFIG2)

Address - 0x03h

DATA BIT	D7	D6	D5	D4	D3	D2	D1	D0
FIELD NAME	EOC[1:0]		V_TERM_45_50[2:0]		V_TERM_50_60[2:0]			
READ/WRITE	R/W	R/W	R/W	R/W	R/W	R/W	R/W	R/W

FIELD NAME	BIT DEFINITION
EOC[1:0] ⁽¹⁾	End of charge configuration 00 - 50 mA 01 - 100 mA 10 - 185 mA 11 - 370 mA
V_TERM_45_50[2:0] ⁽²⁾	Voltage Termination 45-50°C configuration 000 - 3.94 V 001 - 4.00 V 010 - 4.05 V 011 - 4.10 V 100 - 4.12 V 101 - 4.15 V 110 - 4.18 V 111 - Invalid Setting
V_TERM_50_60[2:0] ⁽²⁾	Voltage Termination 50-60°C configuration 000 - 3.94 V 001 - 4.00 V 010 - 4.05 V 011 - 4.10 V 100 - 4.12 V 101 - 4.15 V 110 - 4.18 V 111 - Invalid Setting

(1) EOC Note: Maximum output current when $V_{BAT} < 3.0$ V.

(2) V_TERM Note: Unique settings available for battery temperatures 0-10°C, 10-45°C, 45-50°C, and 50-60°C. For <0°C and >60°C, charging is disabled and a fault is set.

CONFIGURATION REGISTER (CONFIG3)

Address - 0x04h

DATA BIT	D7	D6	D5	D4	D3	D2	D1	D0
FIELD NAME	MAX_CHRG_CURR_0_10[3:0]				MAX_CHRG_CURR_10_45[3:0]			
READ/WRITE	R/W	R/W	R/W	R/W	R/W	R/W	R/W	R/W

FIELD NAME	BIT DEFINITION
MAX_CHRG_CURR_0_10[3:0] ⁽¹⁾	Maximum charge current 0-10°C configuration 0000 - 50 mA 0001 - 100 mA 0010 - 200 mA 0011 - 300 mA 0100 - 400 mA 0101 - 500 mA 0110 - 600 mA 0111 - 700 mA 1000 - 800 mA 1001 - 900 mA 1010 - 1000 mA 1011 - 1100 mA 1100 - 1200 mA 1101 - 1300 mA 1110 - 1400 mA 1111 - 1500 mA
MAX_CHRG_CURR_10_45[3:0] ⁽¹⁾	Maximum charge current 10-45°C configuration 0000 - 50 mA 0001 - 100 mA 0010 - 200 mA 0011 - 300 mA 0100 - 400 mA 0101 - 500 mA 0110 - 600 mA 0111 - 700 mA 1000 - 800 mA 1001 - 900 mA 1010 - 1000 mA 1011 - 1100 mA 1100 - 1200 mA 1101 - 1300 mA 1110 - 1400 mA 1111 - 1500 mA

(1) MAX_CHRG_CURR Note: Unique settings available for battery temperatures 0-10°C, 10-45°C, 45-50°C, and 50-60°C. For <0°C and >60°C, charging is disabled and a fault is set.

CONFIGURATION REGISTER (CONFIG4)

Address - 0x05h

DATA BIT	D7	D6	D5	D4	D3	D2	D1	D0
FIELD NAME	MAX_CHRG_CURR_45_50[3:0]				MAX_CHRG_CURR_50_60[3:0]			
READ/WRITE	R/W	R/W	R/W	R/W	R/W	R/W	R/W	R/W

FIELD NAME	BIT DEFINITION
MAX_CHRG_CURR_45_50[3:0] ⁽¹⁾	Maximum charge current 45-50°C configuration 0000 - 50 mA 0001 - 100 mA 0010 - 200 mA 0011 - 300 mA 0100 - 400 mA 0101 - 500 mA 0110 - 600 mA 0111 - 700 mA 1000 - 800 mA 1001 - 900 mA 1010 - 1000 mA 1011 - 1100 mA 1100 - 1200 mA 1101 - 1300 mA 1110 - 1400 mA 1111 - 1500 mA
MAX_CHRG_CURR_50_60[3:0] ⁽¹⁾	Maximum charge current 50-60°C configuration 0000 - 50 mA 0001 - 100 mA 0010 - 200 mA 0011 - 300 mA 0100 - 400 mA 0101 - 500 mA 0110 - 600 mA 0111 - 700 mA 1000 - 800 mA 1001 - 900 mA 1010 - 1000 mA 1011 - 1100 mA 1100 - 1200 mA 1101 - 1300 mA 1110 - 1400 mA 1111 - 1500 mA

(1) MAX_CHRG_CURR Note: Unique settings available for battery temperatures 0-10°C, 10-45°C, 45-50°C, and 50-60°C. For <0°C and >60°C, charging is disabled and a fault is set.

CONFIGURATION REGISTER (CONFIG5)

Address - 0x06h

DATA BIT	D7	D6	D5	D4	D3	D2	D1	D0
FIELD NAME	TOP_END	TH	TOP_TO[2:0]			1C_TO[2:0]		
READ/WRITE	R/W	R/W	R/W	R/W	R/W	R/W	R/W	R/W

FIELD NAME	BIT DEFINITION
TOP_END ⁽¹⁾	Top Off end configuration 0 - 25 mA 1 - 92 mA
TH ⁽²⁾	Thermistor configuration 0 - 10k Ohms 1 - 100k Ohms
TOP_TO[2:0] ⁽³⁾	Top Off timer time out configuration 000 - 0 minutes 001 - 20 minutes 010 - 40 minutes 011 - 60 minutes 100 - 80 minutes 101 - 100 minutes 110 - 120 minutes 111 - Disable time out timer
1C_TO[2:0] ⁽⁴⁾	Full charge timer time out configuration 000 - Disable full charge timer 001 - 200 minutes 010 - 400 minutes 011 - 600 minutes 100 - 800 minutes 101 - 1000 minutes 110 - 1200 minutes 111 - 1400 minutes

(1) TOP_END Note: Charging stops when $V_{BAT} = V_{termination}$ and $I_{BAT} < \text{Top Off end}$.

(2) TH Note: Setting for nominal thermistor and reference resistor value.

(3) TOP_TO Note: Timer starts when $V_{BAT} = V_{termination}$ and $I_{BAT} < \text{EOC}$.

(4) 1C_TO Note: Timer starts when $V_{BAT} > 3.0V$.

ENABLE CONFIGURATION REGISTER (CONFIG_ENABLE)

Address - 0x11h

DATA BIT	D7	D6	D5	D4	D3	D2	D1	D0
FIELD NAME	Not used	Not used	Not used	Not used	Not used	Not used	Not used	EN_CFG
READ/WRITE	R	R	R	R	R	R	R	R/W
RESET VALUE	0	0	0	0	0	0	0	0

FIELD NAME	BIT DEFINITION
EN_CFG	Enable access control bit for configuration registers 2-6 0 - Disable access 1 - Enable access

EEPROM CONTROL REGISTER (EEPROM_CTRL)

Address - 0x12h

DATA BIT	D7	D6	D5	D4	D3	D2	D1	D0
FIELD NAME	Not used	Not used	Not used	Not used	Not used	Not used	Not used	EE_PROG
READ/WRITE	R	R	R	R	R	R	R	R/W
RESET VALUE	0	0	0	0	0	0	0	0

FIELD NAME	BIT DEFINITION
EE_PROG ⁽¹⁾	EEprom program control bit for configuration registers 2-6 0 - Disable EEprom programming 1 - Enable EEprom programming with data from configuration registers 2-6

(1) EE_PROG Note: Inputs VIN and EN must be present for 200 ms.

EXTERNAL COMPONENT SELECTION

The internal compensation is optimized for a 4.7uF output capacitor and a 4.7uH inductor. To keep the output ripple low, a low ESR (less than 35mOhm) ceramic is recommended.

PACKAGE MECHANICAL DRAWINGS

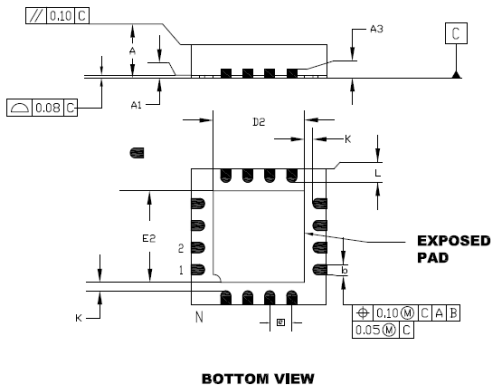
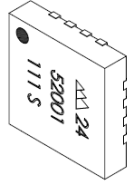
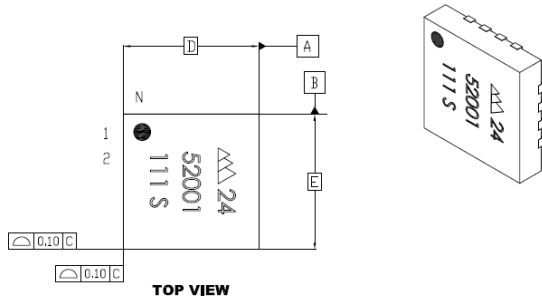

Dimensions	Units	MILLIMETERS		
		MIN	NOM	MAX
Number of Pins	N	16		
Pitch	e	0.65 BSC		
Overall Height	A	0.80	0.90	1.00
Standoff	A1	0.00	0.02	0.05
Contact Thickness	A3	0.20 REF		
Overall Length	D	4.00 BSC		
Exposed Pad Width	E2	2.55	2.70	2.80
Overall Width	E	4.00 BSC		
Exposed Pad Length	D2	2.55	2.70	2.80
Contact Width	b	0.25	0.30	0.35
Contact Length	L	0.30	0.40	0.50
Contact-to-Exposed Pad	K	0.20	-	-

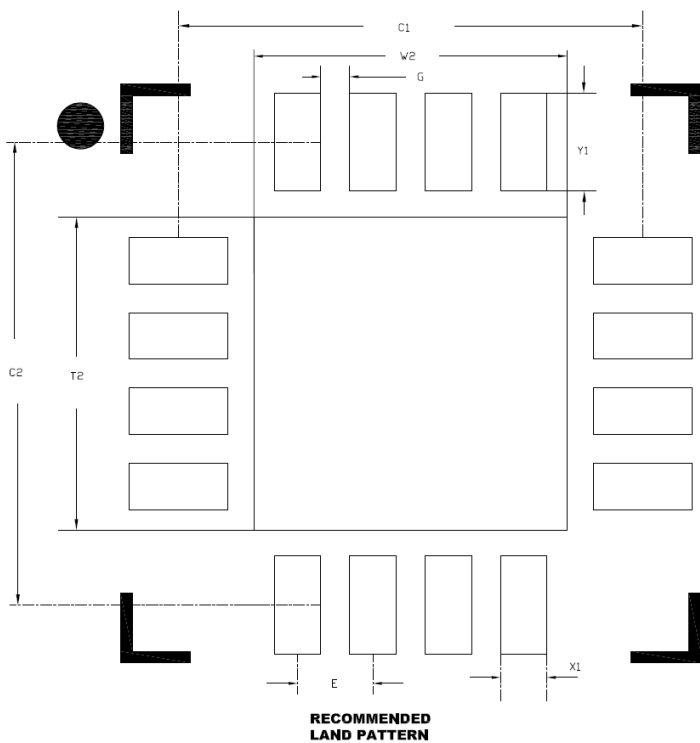

Dimension	Units	MILLIMETERS		
		MIN	NOM	MAX
Contact Pitch	E	0.65 BSC		
Optional Center Pad Width	W2	-	-	2.70
Optional Center Pad Length	T2	-	-	2.70
Contact Pad Spacing	C1	-	4.00	-
Contact Pad Spacing	C2	-	4.00	-
Contact Pad Width (X16)	X1	-	-	0.40
Contact Pad Length (X16)	Y1	-	-	0.85
Distance Between Pads	G	0.25	-	-

Notes:
 Dimensions and tolerancing per ASME Y14.5M
 BSC: Basic Dimension. Theoretically exact value shown without tolerances.
 REF: Reference Dimension, usually without tolerance, for information only.

APPLICATION USING A MULTI-LAYER PCB

To maximize the efficiency of this package for application on a single layer or multi-layer PCB, certain guidelines must be followed when laying out this part on the PCB.

The following are guidelines for mounting the exposed pad IC on a Multi-Layer PCB with ground a plane.

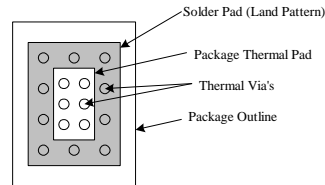

Package and PCB Land Configuration
For a Multi-Layer PCB

JEDEC standard FR4 PCB Cross-section:

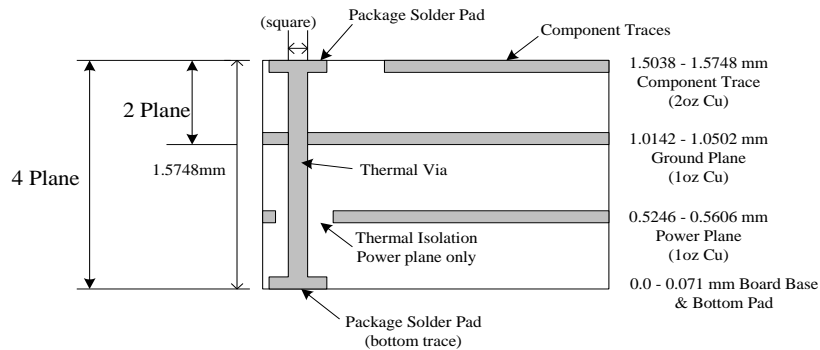

Multi-Layer Board (Cross-sectional View)

In a multi-layer board application, the thermal vias are the primary method of heat transfer from the package thermal pad to the internal ground plane. The efficiency of this method depends on several factors, including die area, number of thermal vias, thickness of copper, etc.

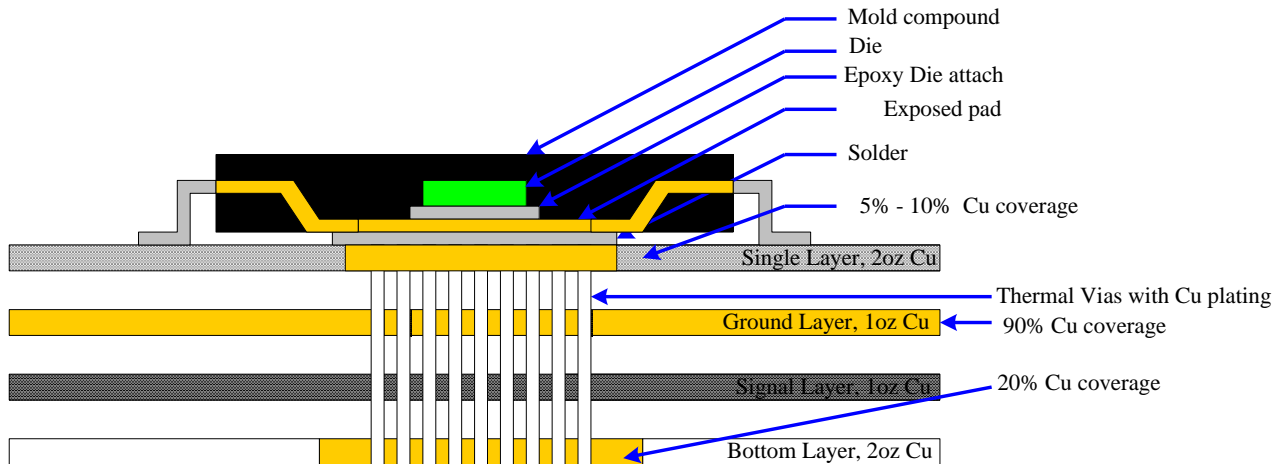

Note: NOT to Scale

The above drawing is a representation of how the heat can be conducted away from the die using an exposed pad package. Each application will have different requirements and limitations and therefore the user should use sufficient copper to dissipate the power in the system. The output current rating for the linear regulators may have to be de-rated for ambient temperatures above 85C. The de-rate value will depend on calculated worst case power dissipation and the thermal management implementation in the application.

APPLICATION USING A SINGLE LAYER PCB

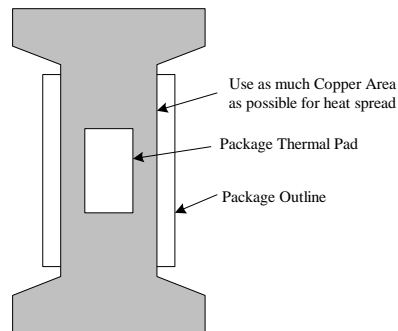

Layout recommendations for a Single Layer PCB: utilize as much Copper Area for Power Management. In a single layer board application the thermal pad is attached to a heat spreader (copper areas) by using low thermal impedance attachment method (solder paste or thermal conductive epoxy).

In both of the methods mentioned above it is advisable to use as much copper traces as possible to dissipate the heat.

IMPORTANT:

If the attachment method is NOT implemented correctly, the functionality of the product is not guaranteed. Power dissipation capability will be adversely affected if the device is incorrectly mounted onto the circuit board.

Legal Notices

Information contained in this publication regarding device applications and the like is provided only for your convenience and may be superseded by updates. It is your responsibility to ensure that your application meets with your specifications. "Typical" parameters which may be provided in Triune Systems data sheets and/or specifications can and do vary in different applications and actual performance may vary over time. All operating parameters, including "Typicals" must be validated for your application by your technical experts. TRIUNE SYSTEMS MAKES NO REPRESENTATIONS OR WARRANTIES OF ANY KIND WHETHER EXPRESS OR IMPLIED, WRITTEN OR ORAL, STATUTORY OR OTHERWISE, RELATED TO THE INFORMATION, INCLUDING BUT NOT LIMITED TO ITS CONDITION, QUALITY, PERFORMANCE, MERCHANTABILITY OR FITNESS FOR PURPOSE. Triune Systems disclaims all liability arising from this information and its use. Triune System products are not designed, intended, or authorized for use as components in systems intended for surgical implant into the body, or other applications intended to support or sustain life, or for any other application in which the failure of the Triune Systems product could create a situation where personal injury or death may occur. Should the Buyer purchase or use Triune Systems products for any such unintended or unauthorized application, the Buyer shall indemnify and hold Triune Systems, and its officers, employees, subsidiaries, affiliates, and distributors harmless against all claims, costs, damages, and expenses, and reasonable attorney fees arising out of, directly or indirectly, any claim of personal injury or death associated with such unintended or unauthorized use, even if such claim alleges that Triune Systems was negligent regarding the design or manufacture of the part. No licenses are conveyed, implicitly or otherwise, under any Triune Systems intellectual property rights.

Trademarks

The Triune Systems® name and logo, MPPT-lite™, and nanoSmart® are trademarks of Triune Systems, LLC. in the U.S.A..

All other trademarks mentioned herein are property of their respective companies.

© 2012 Triune Systems, LLC. All Rights Reserved.