

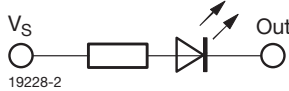

Resistor LED for 12 V Supply Voltage

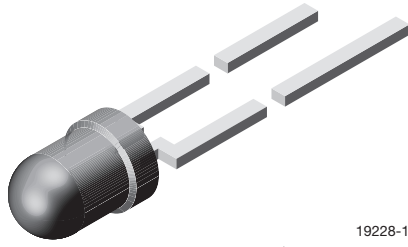

FEATURES

- With current limiting resistor for 12 V
- EMC specified (DIN 40 839)
- Resistant against transient high voltage spikes
- Cost effective: save space and resistor cost
- Standard Ø 3 mm (T-1) package
- Wide viewing angle
- Choice of four bright colors
- Luminous intensity categorized
- Yellow and green color categorized
- Material categorization: For definitions of compliance please see www.vishay.com/doc?99912



RoHS COMPLIANT

DESCRIPTION

These devices are developed for the automotive industry with special requirements as for EMC (electro magnetic compatibility) in motor vehicles with 12 V supply voltage.

They are resistant against transient conduction (high voltage spikes) and interferences by conduction and coupling.

The TLR.4420CU series contains an integrated resistor for current limiting in series with the LED chip. This allows the lamp to be driven from a 12 V source without an external current limiter.

Available colors are red, soft orange, yellow and green. These tinted diffused lamps provide a wide off-axis viewing angle.

These LEDs are intended for space critical applications such as automobile instrument panels, switches and others which are driven from a 12 V source.

APPLICATIONS

- Status light in cars
- Off/on indicator in cars
- Background illumination for switches
- Off/on indicator in switches

PRODUCT GROUP AND PACKAGE DATA

- Product group: LED
- Package: 3 mm resistor
- Product series: standard
- Angle of half intensity: ± 30°

PARTS TABLE														
PART	COLOR	LUMINOUS INTENSITY (mcd)			at V _s (V)	WAVELENGTH (nm)			at V _s (V)	FORWARD VOLTAGE (V)			at V _s (V)	TECHNOLOGY
		MIN.	TYP.	MAX.		MIN.	TYP.	MAX.		MIN.	TYP.	MAX.		
TLRH4420CU	Red	1.6	10	-	12	612	-	625	12	-	10	12	12	GaAsP on GaP
TLRO4420CU	Soft orange	4	10	-	12	598	-	611	12	-	10	12	12	GaAsP on GaP
TLRY4420CU	Yellow	1.6	10	-	12	581	-	594	12	-	10	12	12	GaAsP on GaP
TLRG4420CU	Green	1.6	10	-	12	562	-	575	12	-	10	12	12	GaP on GaP

ABSOLUTE MAXIMUM RATINGS (T _{amb} = 25 °C, unless otherwise specified)				
TLRH4420CU , TLRO4420CU , TLR4420CU , TLRG4420CU				
PARAMETER	TEST CONDITION	SYMBOL	VALUE	UNIT
Reverse voltage		V _R	6	V
Forward voltage	T _{amb} ≤ 65 °C	V _F	16	V
Power dissipation	T _{amb} ≤ 65 °C	P _V	240	mW
Junction temperature		T _j	100	°C
Operating temperature range		T _{amb}	- 40 to + 100	°C
Storage temperature range		T _{stg}	- 55 to + 100	°C
Soldering temperature	t ≤ 5 s, 2 mm from body	T _{sd}	260	°C
Thermal resistance junction/ambient		R _{thJA}	150	K/W



OPTICAL AND ELECTRICAL CHARACTERISTICS ($T_{amb} = 25\text{ }^{\circ}\text{C}$, unless otherwise specified)						
TLRH4420CU, RED						
PARAMETER	TEST CONDITION	SYMBOL	MIN.	TYP.	MAX.	UNIT
Luminous intensity ⁽¹⁾	$V_S = 12\text{ V}$	I_V	1.6	10	-	mcd
Dominant wavelength	$V_S = 12\text{ V}$	λ_d	612	-	625	nm
Peak wavelength	$V_S = 12\text{ V}$	λ_p	-	635	-	nm
Angle of half intensity	$V_S = 12\text{ V}$	ϕ	-	± 30	-	deg
Forward current	$V_S = 12\text{ V}$	I_F	-	10	12	mA
Breakdown voltage	$I_R = 10\text{ }\mu\text{A}$	V_{BR}	6	70	-	V
Junction capacitance	$V_R = 0\text{ V}, f = 1\text{ MHz}$	C_j	-	50	-	pF

Note

⁽¹⁾ In one packing unit $I_{Vmin}/I_{Vmax} \leq 0.5$.

OPTICAL AND ELECTRICAL CHARACTERISTICS ($T_{amb} = 25\text{ }^{\circ}\text{C}$, unless otherwise specified)						
TLRO4420CU, SOFT ORANGE						
PARAMETER	TEST CONDITION	SYMBOL	MIN.	TYP.	MAX.	UNIT
Luminous intensity ⁽¹⁾	$V_S = 12\text{ V}$	I_V	4	10	-	mcd
Dominant wavelength	$V_S = 12\text{ V}$	λ_d	598	-	611	nm
Peak wavelength	$V_S = 12\text{ V}$	λ_p	-	605	-	nm
Angle of half intensity	$V_S = 12\text{ V}$	ϕ	-	± 30	-	deg
Forward current	$V_S = 12\text{ V}$	I_F	-	10	12	mA
Breakdown voltage	$I_R = 10\text{ }\mu\text{A}$	V_{BR}	6	70	-	V
Junction capacitance	$V_R = 0, f = 1\text{ MHz}$	C_j	-	50	-	pF

Note

⁽¹⁾ In one packing unit $I_{Vmin}/I_{Vmax} \leq 0.5$.

OPTICAL AND ELECTRICAL CHARACTERISTICS ($T_{amb} = 25\text{ }^{\circ}\text{C}$, unless otherwise specified)						
TLR4420CU, YELLOW						
PARAMETER	TEST CONDITION	SYMBOL	MIN.	TYP.	MAX.	UNIT
Luminous intensity ⁽¹⁾	$V_S = 12\text{ V}$	I_V	1.6	10	-	mcd
Dominant wavelength	$V_S = 12\text{ V}$	λ_d	581	-	594	nm
Peak wavelength	$V_S = 12\text{ V}$	λ_p	-	585	-	nm
Angle of half intensity	$V_S = 12\text{ V}$	ϕ	-	± 30	-	deg
Forward current	$V_S = 12\text{ V}$	I_F	-	10	12	mA
Breakdown voltage	$I_R = 10\text{ }\mu\text{A}$	V_{BR}	6	70	-	V
Junction capacitance	$V_R = 0, f = 1\text{ MHz}$	C_j	-	50	-	pF

Note

⁽¹⁾ In one packing unit $I_{Vmin}/I_{Vmax} \leq 0.5$.

OPTICAL AND ELECTRICAL CHARACTERISTICS ($T_{amb} = 25\text{ }^{\circ}\text{C}$, unless otherwise specified)						
TLRG4420CU, GREEN						
PARAMETER	TEST CONDITION	SYMBOL	MIN.	TYP.	MAX.	UNIT
Luminous intensity ⁽¹⁾	$V_S = 12\text{ V}$	I_V	1.6	10	-	mcd
Dominant wavelength	$V_S = 12\text{ V}$	λ_d	562	-	575	nm
Peak wavelength	$V_S = 12\text{ V}$	λ_p	-	565	-	nm
Angle of half intensity	$V_S = 12\text{ V}$	ϕ	-	± 30	-	deg
Forward current	$V_S = 12\text{ V}$	I_F	-	10	12	mA
Breakdown voltage	$I_R = 10\text{ }\mu\text{A}$	V_{BR}	6	70	-	V
Junction capacitance	$V_R = 0, f = 1\text{ MHz}$	C_j	-	50	-	pF

Note

⁽¹⁾ In one packing unit $I_{Vmin}/I_{Vmax} \leq 0.5$.



TYPICAL CHARACTERISTICS (T_{amb} = 25 °C, unless otherwise specified)

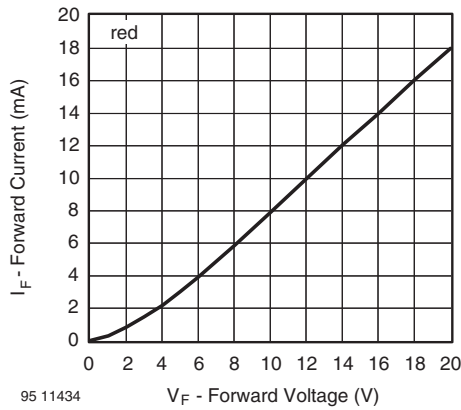

Fig. 1 - Forward Current vs. Forward Voltage

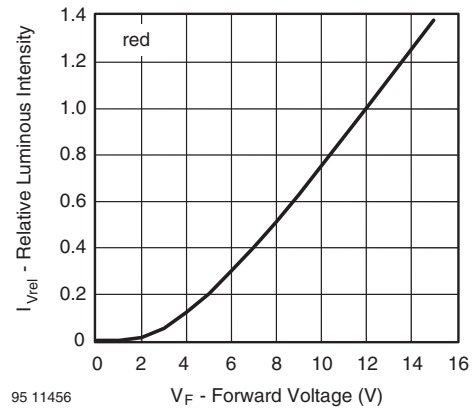

Fig. 4 - Relative Luminous Intensity vs. Forward Voltage

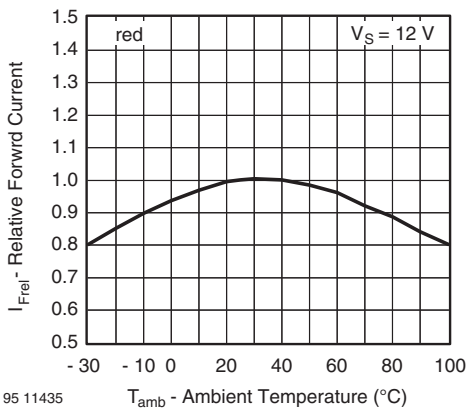

Fig. 2 - Relative Forward Current vs. Ambient Temperature

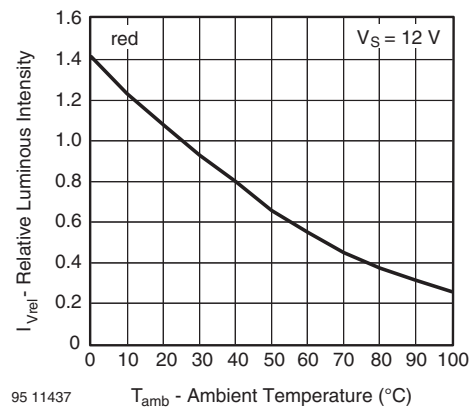

Fig. 5 - Relative Luminous Intensity vs. Ambient Temperature

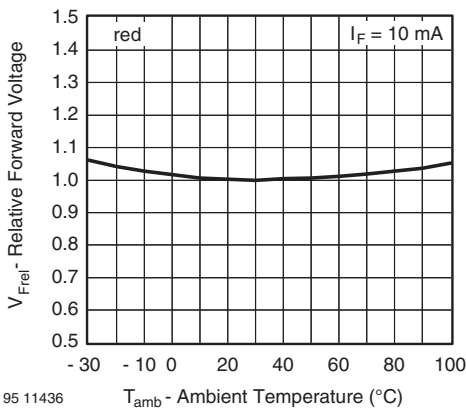

Fig. 3 - Relative Forward Voltage vs. Ambient Temperature

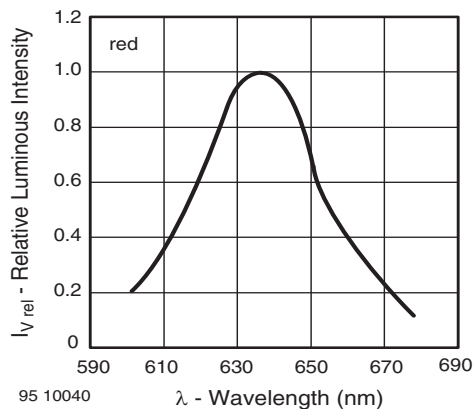
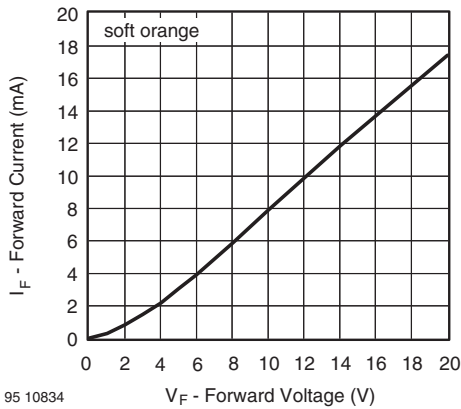
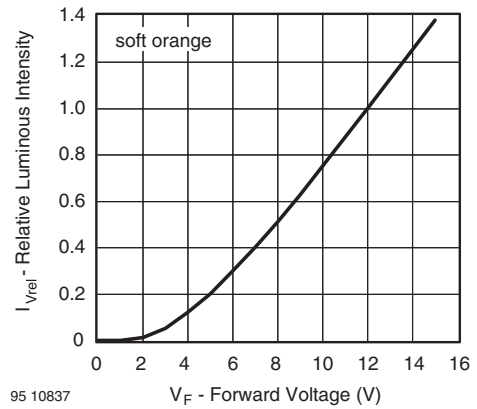

Fig. 6 - Relative Intensity vs. Wavelength



95 10834

Fig. 7 - Forward Current vs. Forward Voltage



95 10837

Fig. 10 - Relative Luminous Intensity vs. Forward Voltage

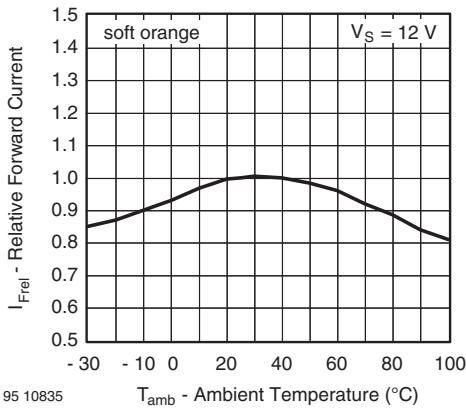

95 10835

Fig. 8 - Relative Forward Current vs. Ambient Temperature

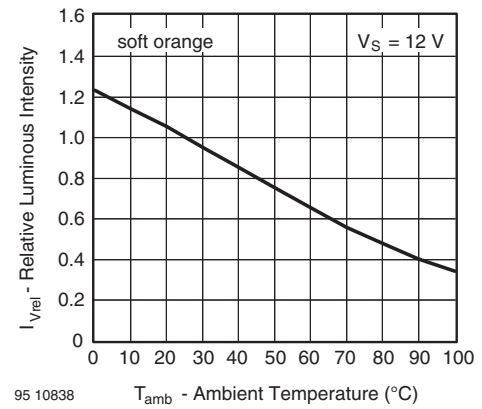

95 10838

Fig. 11 - Relative Luminous Intensity vs. Ambient Temperature

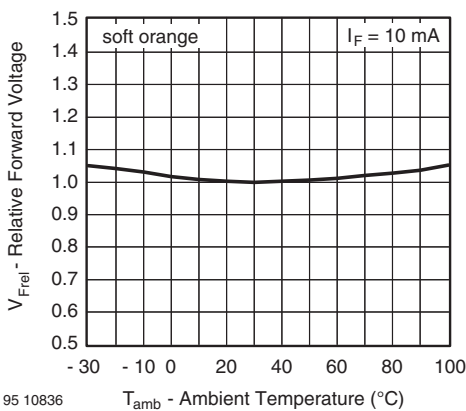

95 10836

Fig. 9 - Relative Forward Voltage vs. Ambient Temperature

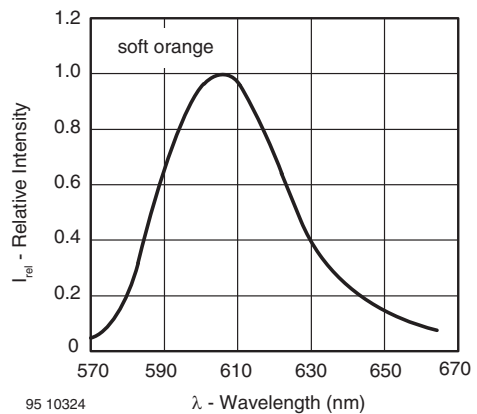

95 10324

Fig. 12 - Relative Intensity vs. Wavelength

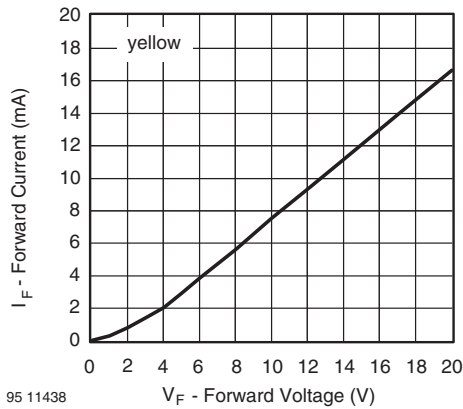

Fig. 13 - Forward Current vs. Forward Voltage

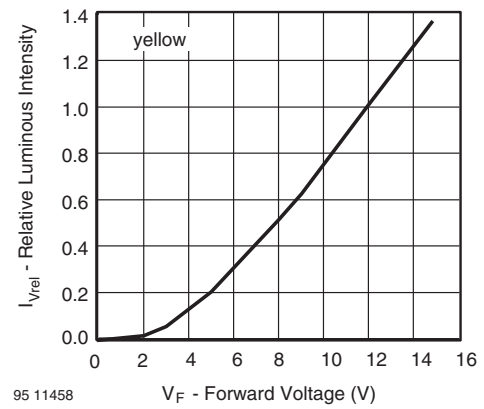

Fig. 16 - Relative Luminous Intensity vs. Forward Voltage

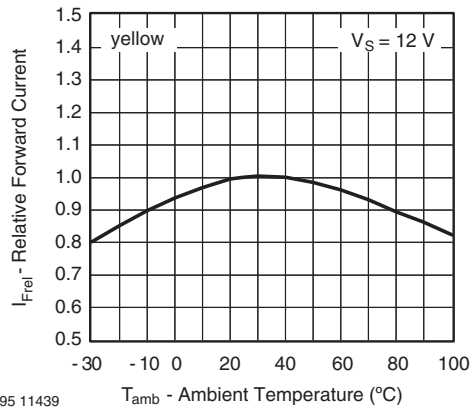

Fig. 14 - Relative Forward Current vs. Ambient Temperature

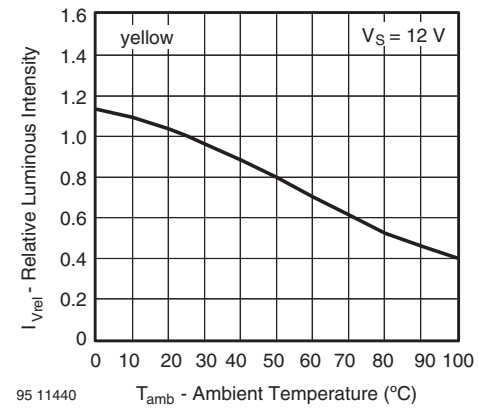

Fig. 17 - Relative Luminous Intensity vs. Ambient Temperature

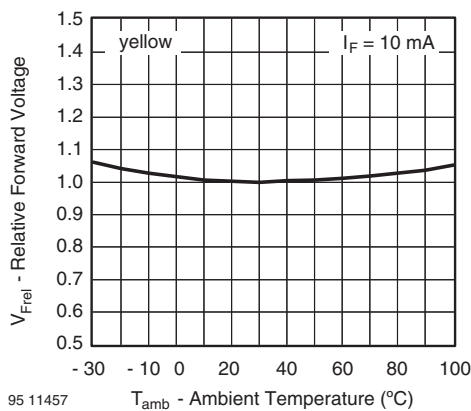

Fig. 15 - Relative Forward Voltage vs. Ambient Temperature

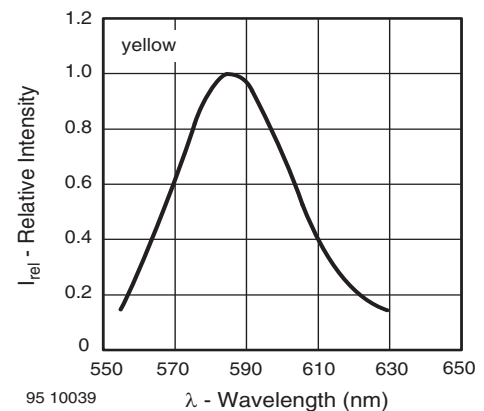

Fig. 18 - Relative Intensity vs. Wavelength

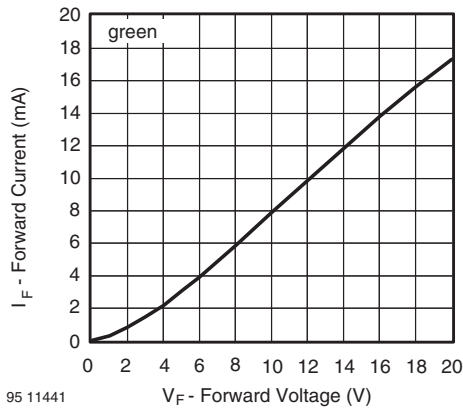

Fig. 19 - Forward Current vs. Forward Voltage

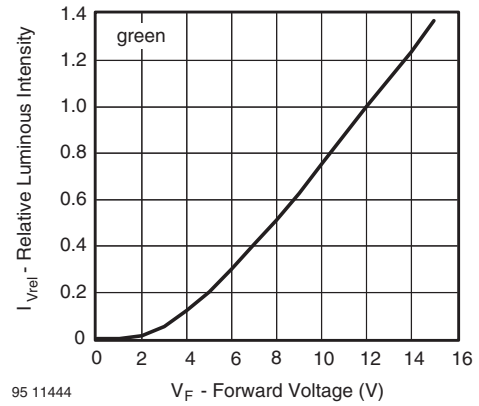

Fig. 22 - Relative Luminous Intensity vs. Forward Voltage

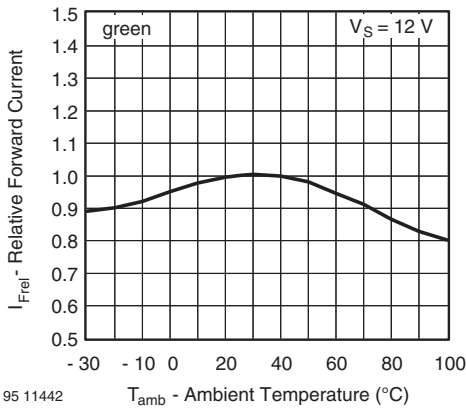

Fig. 20 - Relative Forward Current vs. Ambient Temperature

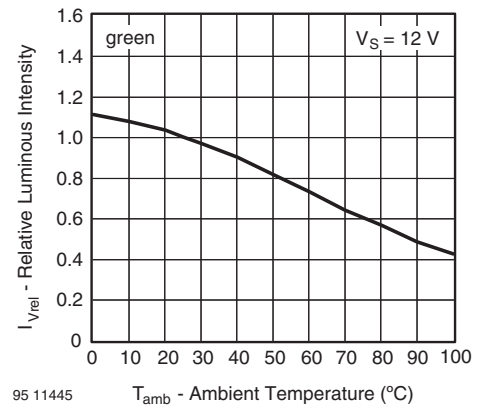

Fig. 23 - Relative Luminous Intensity vs. Ambient Temperature

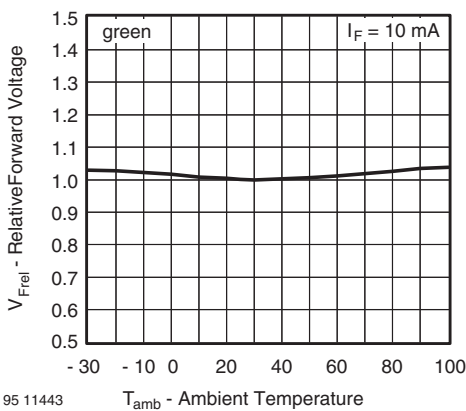

Fig. 21 - Relative Forward Voltage vs. Ambient Temperature

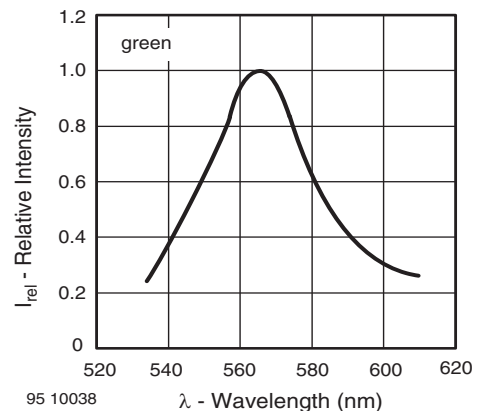

Fig. 24 - Relative Intensity vs. Wavelength

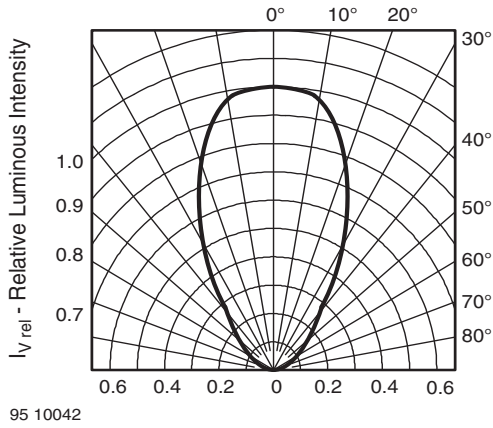
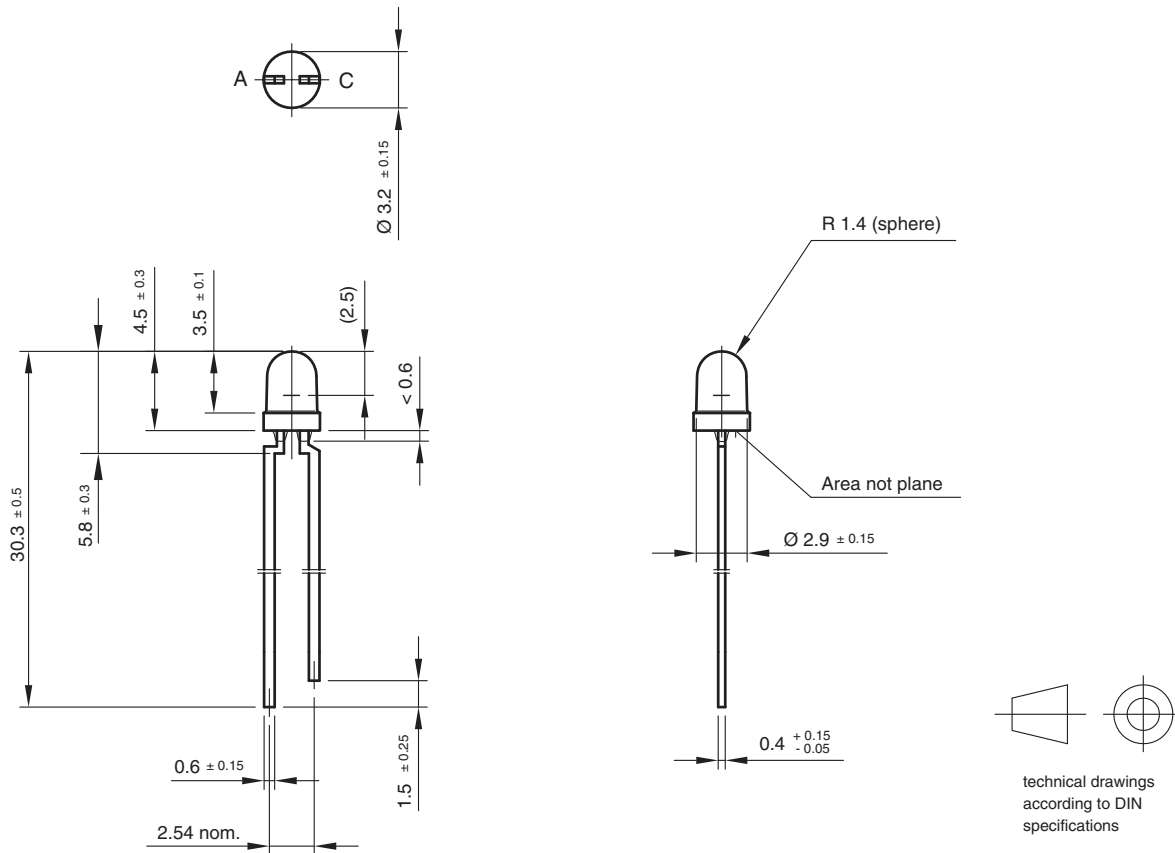

Fig. 25 - Relative Luminous Intensity vs. Angular Displacement

PACKAGE DIMENSIONS in millimeters



Drawing-No.: 6.544-5255.01-4
Issue: 7; 25.09.08
95 10913



Disclaimer

ALL PRODUCT, PRODUCT SPECIFICATIONS AND DATA ARE SUBJECT TO CHANGE WITHOUT NOTICE TO IMPROVE RELIABILITY, FUNCTION OR DESIGN OR OTHERWISE.

Vishay Intertechnology, Inc., its affiliates, agents, and employees, and all persons acting on its or their behalf (collectively, "Vishay"), disclaim any and all liability for any errors, inaccuracies or incompleteness contained in any datasheet or in any other disclosure relating to any product.

Vishay makes no warranty, representation or guarantee regarding the suitability of the products for any particular purpose or the continuing production of any product. To the maximum extent permitted by applicable law, Vishay disclaims (i) any and all liability arising out of the application or use of any product, (ii) any and all liability, including without limitation special, consequential or incidental damages, and (iii) any and all implied warranties, including warranties of fitness for particular purpose, non-infringement and merchantability.

Statements regarding the suitability of products for certain types of applications are based on Vishay's knowledge of typical requirements that are often placed on Vishay products in generic applications. Such statements are not binding statements about the suitability of products for a particular application. It is the customer's responsibility to validate that a particular product with the properties described in the product specification is suitable for use in a particular application. Parameters provided in datasheets and/or specifications may vary in different applications and performance may vary over time. All operating parameters, including typical parameters, must be validated for each customer application by the customer's technical experts. Product specifications do not expand or otherwise modify Vishay's terms and conditions of purchase, including but not limited to the warranty expressed therein.

Except as expressly indicated in writing, Vishay products are not designed for use in medical, life-saving, or life-sustaining applications or for any other application in which the failure of the Vishay product could result in personal injury or death. Customers using or selling Vishay products not expressly indicated for use in such applications do so at their own risk. Please contact authorized Vishay personnel to obtain written terms and conditions regarding products designed for such applications.

No license, express or implied, by estoppel or otherwise, to any intellectual property rights is granted by this document or by any conduct of Vishay. Product names and markings noted herein may be trademarks of their respective owners.

Material Category Policy

Vishay Intertechnology, Inc. hereby certifies that all its products that are identified as RoHS-Compliant fulfill the definitions and restrictions defined under Directive 2011/65/EU of The European Parliament and of the Council of June 8, 2011 on the restriction of the use of certain hazardous substances in electrical and electronic equipment (EEE) - recast, unless otherwise specified as non-compliant.

Please note that some Vishay documentation may still make reference to RoHS Directive 2002/95/EC. We confirm that all the products identified as being compliant to Directive 2002/95/EC conform to Directive 2011/65/EU.

Vishay Intertechnology, Inc. hereby certifies that all its products that are identified as Halogen-Free follow Halogen-Free requirements as per JEDEC JS709A standards. Please note that some Vishay documentation may still make reference to the IEC 61249-2-21 definition. We confirm that all the products identified as being compliant to IEC 61249-2-21 conform to JEDEC JS709A standards.