

## HIGH SPEED SWITCHING APPLICATION

### Features

- Low drain-source On resistance:  $R_{DS(on)}=1.05\Omega$  (Typ.)
- Low gate charge:  $Q_g=21nC$  (Typ.)
- Low reverse transfer capacitance:  $C_{rss}=5pF$  (Typ.)
- Lower EMI noise
- RoHS compliant device
- 100% avalanche tested

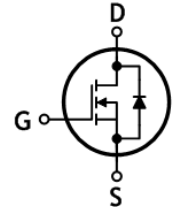
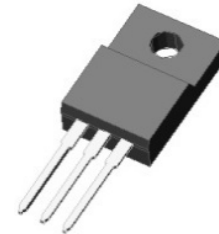

G D S

TO-220F-3L

### Ordering Information

Part Number	Marking	Package
SUN07A60F	SUN07A60	TO-220F-3L

### Marking Information

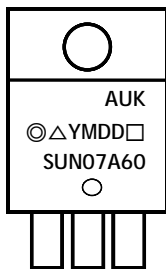

Column 1: Manufacturer  
 Column 2: Production Information

e.g.) ◎△YMDD□

- . ◎: Option Code
- . △: Factory Management Code
- . YMDD: Date Code (Year, Month, Daily)
- . □: Package Option Code

Column 3: Device Code

### Absolute maximum ratings ( $T_C=25^\circ\text{C}$ unless otherwise noted)

Characteristic	Symbol	Rating	Unit	
Drain-source voltage	$V_{DSS}$	600	V	
Gate-source voltage	$V_{GSS}$	±30	V	
Drain current (DC) *	$I_D$	$T_C=25^\circ\text{C}$	7	A
		$T_C=100^\circ\text{C}$	4.43	A
Drain current (Pulsed) *	$I_{DM}$	28	A	
Single avalanche energy <sup>(Note 2)</sup>	$E_{AS}$	93.5	mJ	
Repetitive avalanche current <sup>(Note 1)</sup>	$I_{AR}$	7	A	
Repetitive avalanche energy <sup>(Note 1)</sup>	$E_{AR}$	3.2	mJ	
Power dissipation	$P_D$	32	W	
Junction temperature	$T_J$	150	°C	
Storage temperature range	$T_{stg}$	-55-150	°C	

\* Limited only maximum junction temperature

## Thermal Characteristics

Characteristic	Symbol	Rating	Unit
Thermal resistance, junction to case	$R_{th(j-c)}$	Max. 3.9	°C/W
Thermal resistance, junction to ambient	$R_{th(j-a)}$	Max. 62.5	

## Electrical Characteristics ( $T_C=25^\circ\text{C}$ unless otherwise noted)

Characteristic	Symbol	Test Condition	Min.	Typ.	Max.	Unit
Drain-source breakdown voltage	$BV_{DSS}$	$I_D=250\mu\text{A}$ , $V_{GS}=0$	600	-	-	V
Gate threshold voltage	$V_{GS(th)}$	$I_D=250\mu\text{A}$ , $V_{DS}=V_{GS}$	3	-	5	V
Drain-source cut-off current	$I_{DSS}$	$V_{DS}=600\text{V}$ , $V_{GS}=0\text{V}$	-	-	1	$\mu\text{A}$
		$V_{DS}=600\text{V}$ , $T_C=150^\circ\text{C}$	-	-	100	$\mu\text{A}$
Gate leakage current	$I_{GSS}$	$V_{DS}=0\text{V}$ , $V_{GS}=\pm 30\text{V}$	-	-	$\pm 100$	nA
Drain-source on-resistance	$R_{DS(ON)}$	$V_{GS}=10\text{V}$ , $I_D=3.5\text{A}$	-	1.05	1.2	$\Omega$
Forward transfer conductance (Note 3)	$g_{fs}$	$V_{DS}=10\text{V}$ , $I_D=3.5\text{A}$	-	7.8	-	S
Input capacitance	$C_{iss}$	$V_{DS}=25\text{V}$ , $V_{GS}=0\text{V}$ , $f=1.0\text{MHz}$	-	1350	-	pF
Output capacitance	$C_{oss}$		-	93	-	
Reverse transfer capacitance	$C_{rss}$		-	5	-	
Turn-on delay time (Note 3,4)	$t_{d(on)}$	$V_{DS}=300\text{V}$ , $I_D=7\text{A}$ , $R_G=25\Omega$	-	68	-	ns
Rise time (Note 3,4)	$t_r$		-	38	-	
Turn-off delay time (Note 3,4)	$t_{d(off)}$		-	129	-	
Fall time (Note 3,4)	$t_f$		-	24	-	
Total gate charge (Note 3,4)	$Q_g$	$V_{DS}=480\text{V}$ , $V_{GS}=10\text{V}$ , $I_D=7\text{A}$	-	21	27	nC
Gate-source charge (Note 3,4)	$Q_{gs}$		-	9	-	
Gate-drain charge (Note 3,4)	$Q_{gd}$		-	5	-	

## Source-Drain Diode Ratings and Characteristics ( $T_C=25^\circ\text{C}$ unless otherwise noted)

Characteristic	Symbol	Test Condition	Min.	Typ.	Max.	Unit
Source current (DC)	$I_S$	Integral reverse diode in the MOSFET	-	-	7	A
Source current (Pulsed)	$I_{SM}$		-	-	28	A
Forward voltage	$V_{SD}$	$V_{GS}=0\text{V}$ , $I_{SD}=7\text{A}$	-	-	1.4	V
Reverse recovery time (Note 3,4)	$t_{rr}$	$I_{SD}=7\text{A}$ , $V_{GS}=0\text{V}$ $di_F/dt=100\text{A}/\mu\text{s}$	-	386	-	ns
Reverse recovery charge (Note 3,4)	$Q_{rr}$		-	1.6	-	$\mu\text{C}$

Note:

1. Repeated rating: Pulse width limited by safe operating area
2.  $L=3.5\text{mH}$ ,  $I_{AS}=7\text{A}$ ,  $V_{DD}=50\text{V}$ ,  $R_G=25\Omega$ , Starting  $T_J=25^\circ\text{C}$
3. Pulse test: Pulse width  $\leq 300\mu\text{s}$ , Duty cycle  $\leq 2\%$
4. Essentially independent of operating temperature typical characteristics

## Typical Electrical Characteristics Curves

Fig. 1 Typical Output Characteristics

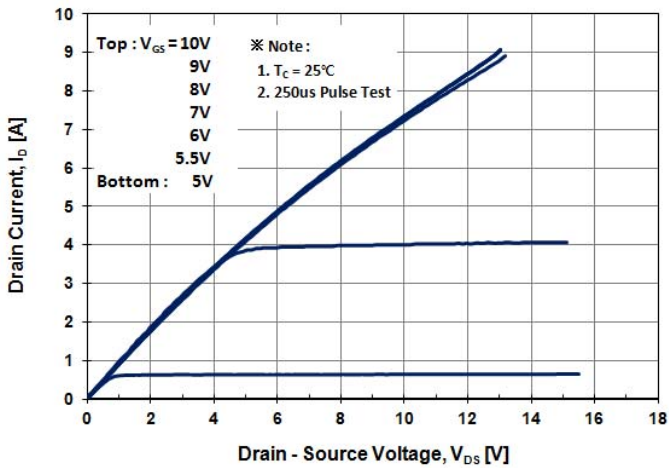

Fig. 2 Typical Output Characteristics

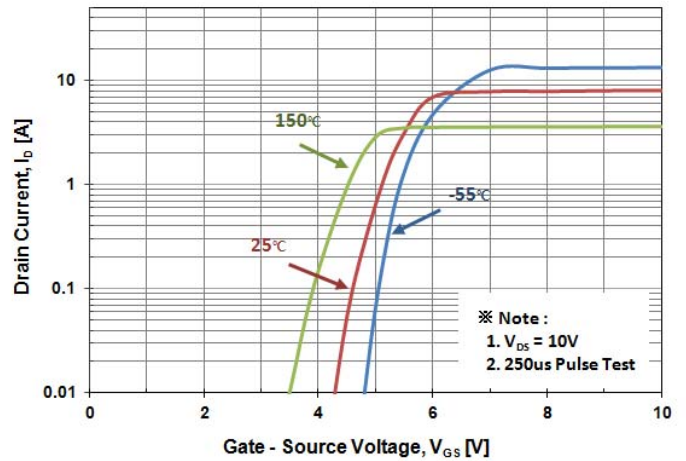

Fig.3 On-Resistance Variation with Drain Current and Gate Voltage

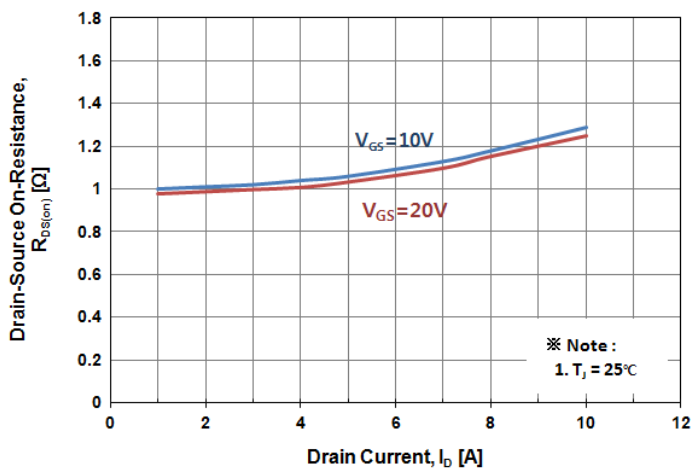

Fig. 4 Body Diode Forward Voltage Variation with Source Current

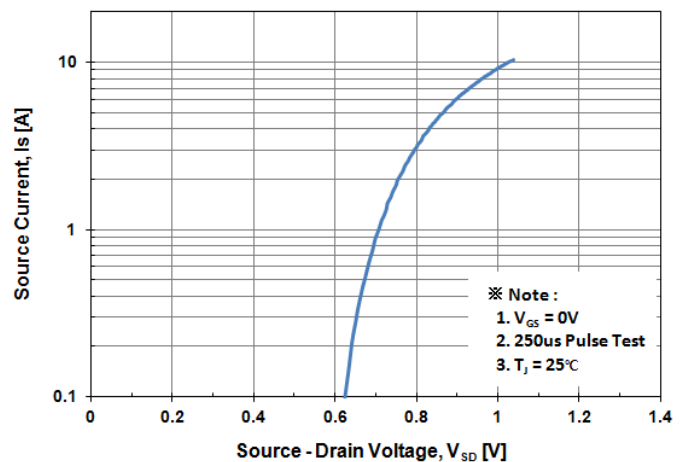

Fig. 5 Typical Capacitance Characteristics

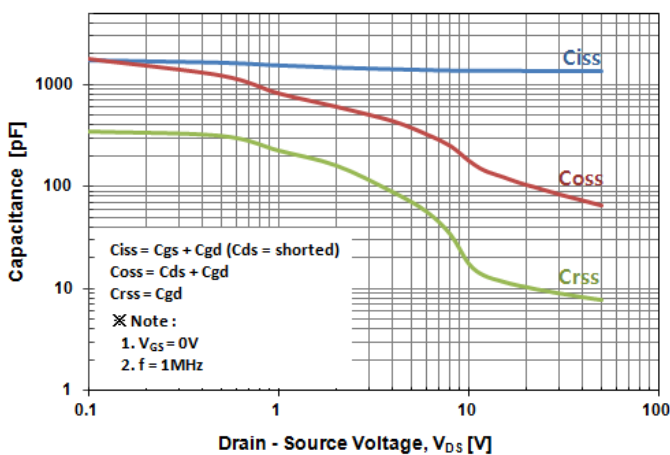

Fig. 6 Typical Total Gate Charge Characteristics

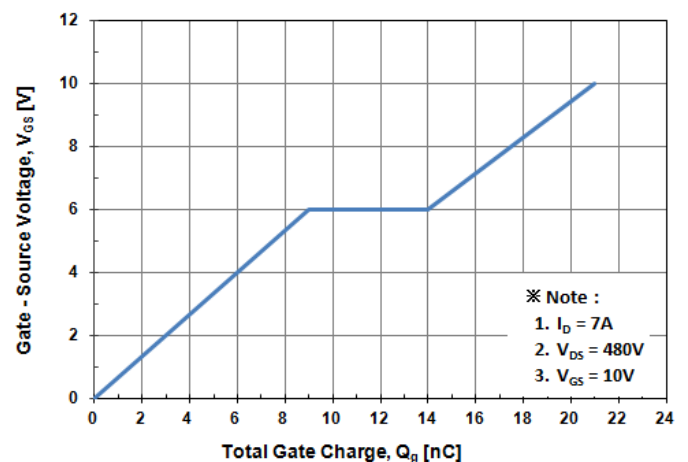

Fig. 7 Breakdown Voltage Variation vs. Temperature

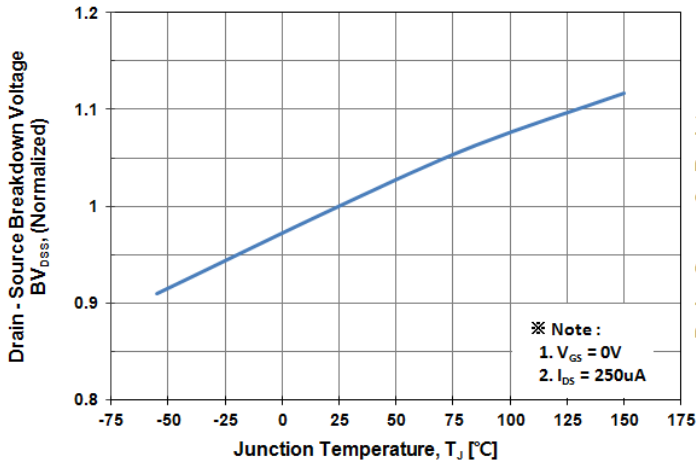

Fig. 8 On-Resistance Variation vs. Temperature

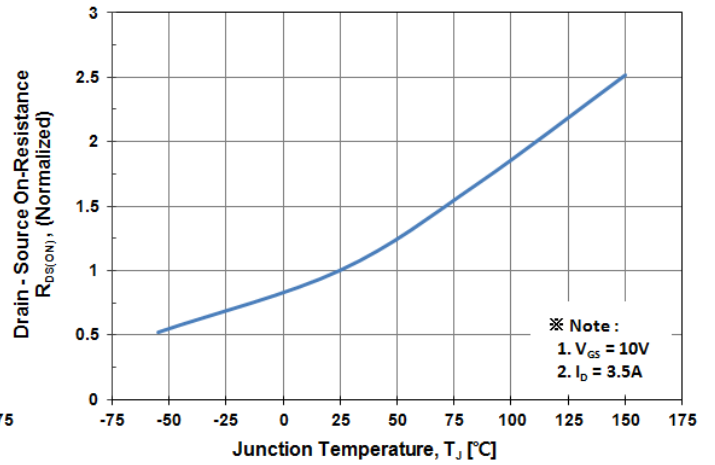

Fig. 9 Maximum Drain Current vs. Case Temperature

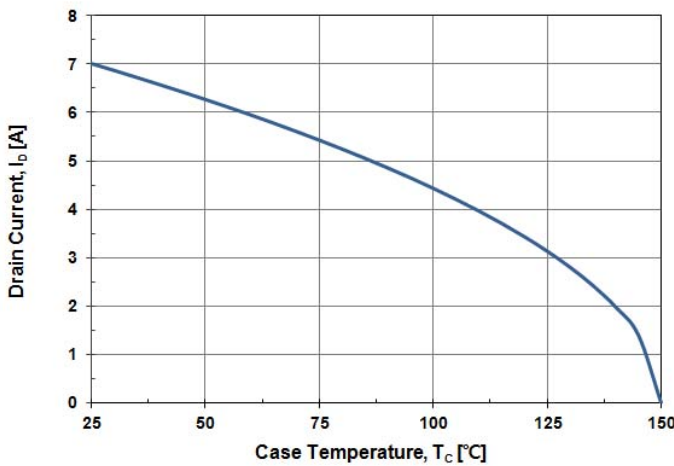

Fig. 10 Maximum Safe Operating Area

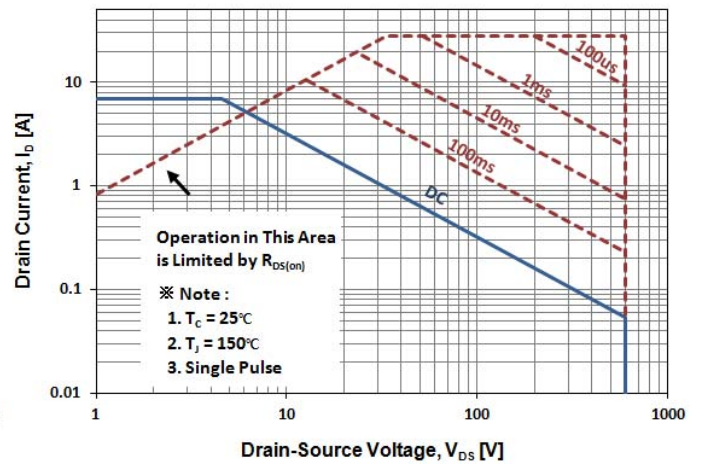

Fig. 11 Transient Thermal Impedance

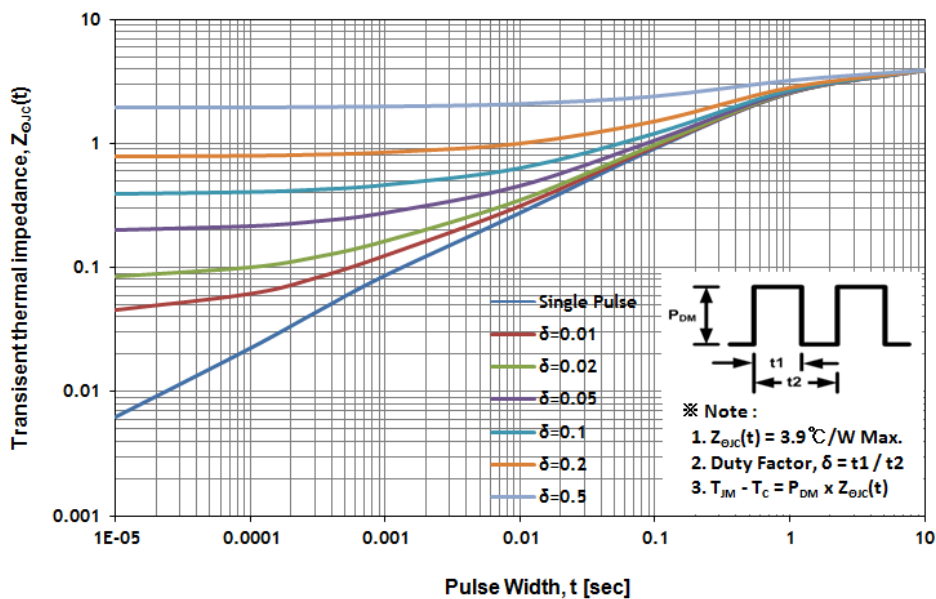

Fig. 12 Gate Charge Test Circuit & Waveform

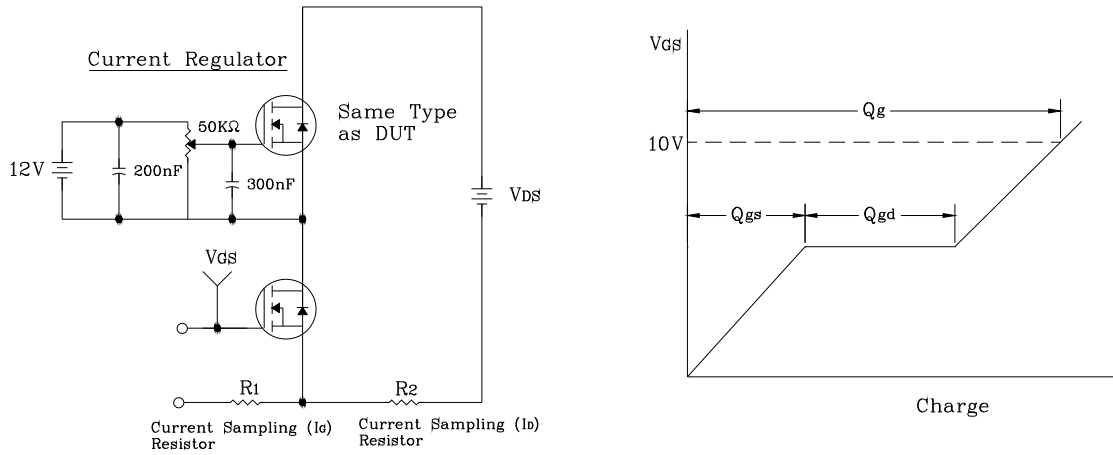

Fig. 13 Resistive Switching Test Circuit & Waveform

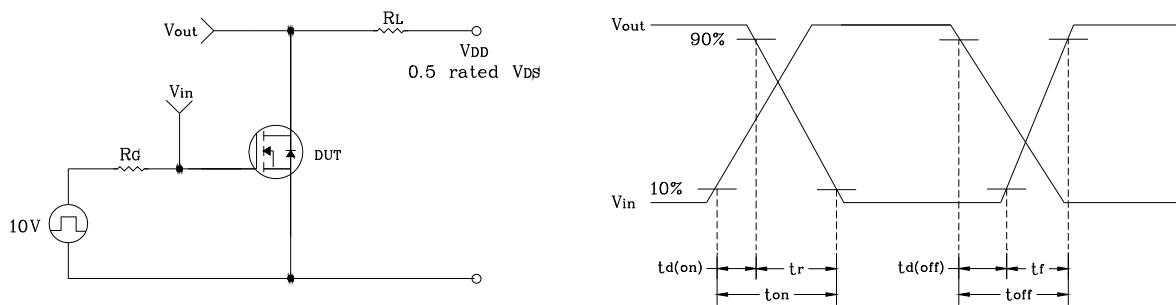

Fig. 14  $E_{AS}$  Test Circuit & Waveform

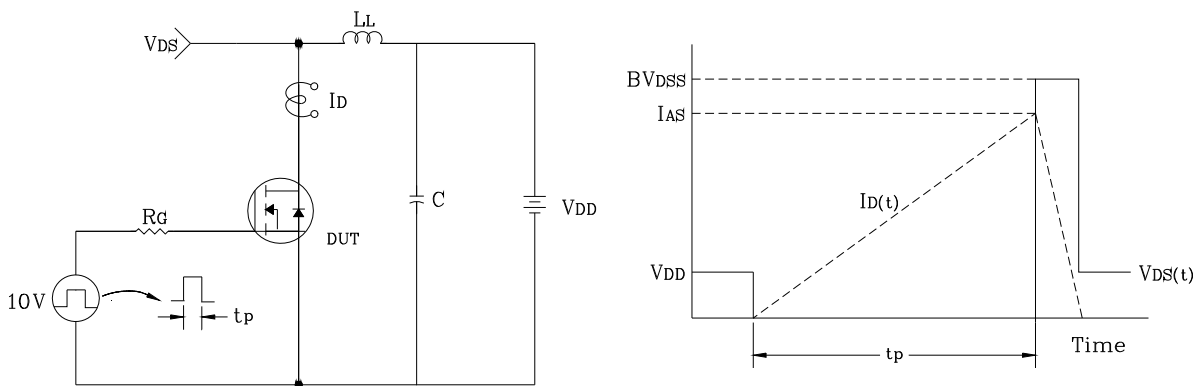
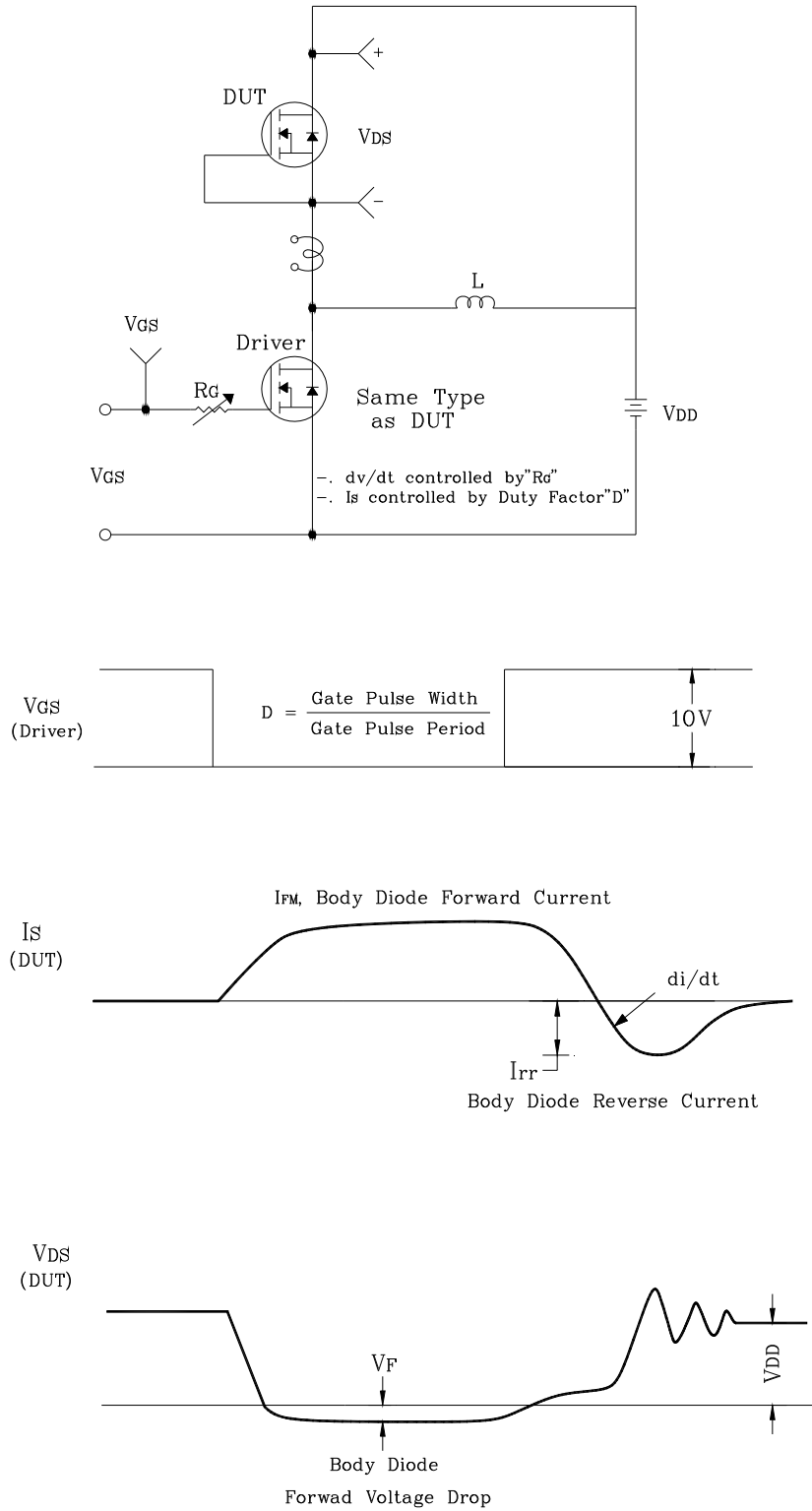
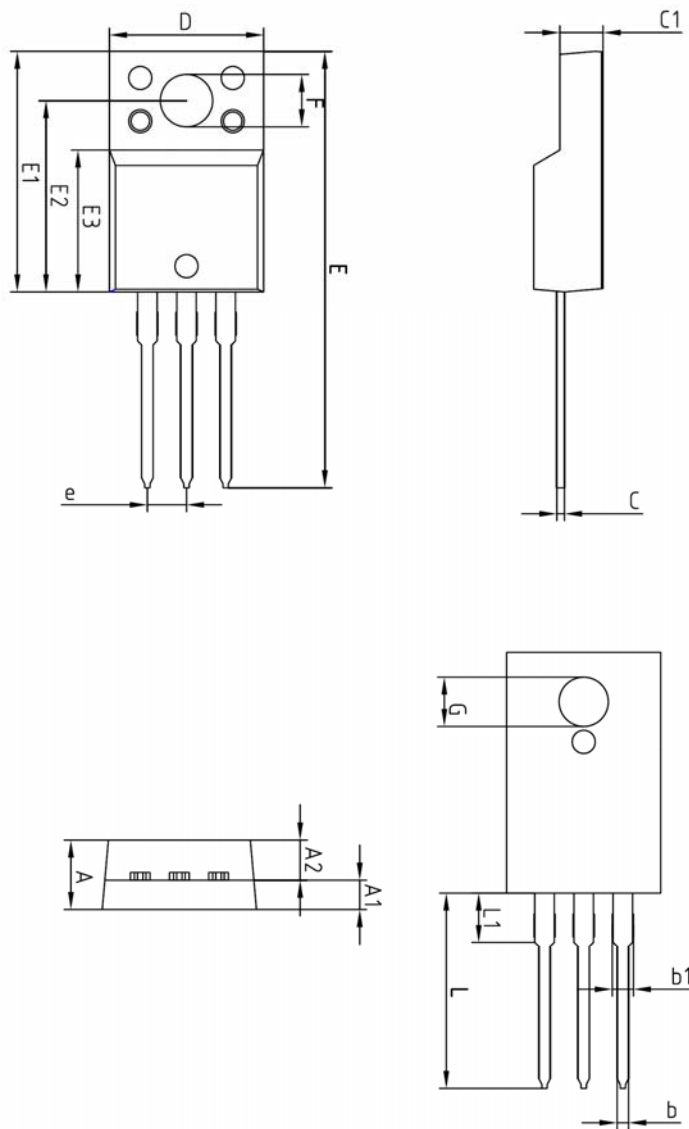

Fig. 15 Diode Reverse Recovery Time Test Circuit & Waveform



Package Outline Dimensions



SYMBOL	MILLIMETERS			NOTE
	MINIMUM	NOMINAL	MAXIMUM	
A	-	-	4.60	
A1	2.45	2.50	2.55	
A2	1.95	2.00	2.05	
b	0.65	0.75	0.85	
b1	1.07	1.27	1.47	
C	0.40	0.50	0.60	
C1	2.70	2.80	2.90	
D	9.90	10.00	10.10	
E	28.00	-	28.60	
E1	15.50	15.60	15.70	
E2	12.30	12.40	12.50	
E3	9.15	9.20	9.25	
F	3.30	3.40	3.50	
G	3.10	3.20	3.30	
e	2.54 BSC			
L	12.40	-	13.00	
L1	3.46 BSC			

The AUK Corp. products are intended for the use as components in general electronic equipment (Office and communication equipment, measuring equipment, home appliance, etc.).

Please make sure that you consult with us before you use these AUK Corp. products in equipments which require high quality and / or reliability, and in equipments which could have major impact to the welfare of human life(atomic energy control, airplane, spaceship, transportation, combustion control, all types of safety device, etc.). AUK Corp. cannot accept liability to any damage which may occur in case these AUK Corp. products were used in the mentioned equipments without prior consultation with AUK Corp..

Specifications mentioned in this publication are subject to change without notice.