

Features

- ✧ Low power loss, high efficiency
- ✧ Metal to silicon rectifier, majority carrier conduction
- ✧ High surge current capability, Low VF, Easy pick and place
- ✧ Plastic material used carriers Underwriters Laboratory Classification 94V-0
- ✧ Epitaxial construction
- ✧ Guard-ring for transient protection
- ✧ High temperature soldering guaranteed: 260°C/10s at terminals
- ✧ Meet MSL level 1, per J-STD-020D lead free, maximum peak of 260°C
- ✧ Green compound with suffix "G" on packing code & prefix "G" on datecode



Mechanical Data

- ✧ Case: SMA/DO-214AC
- ✧ Lead: Pure tin plated, lead free, solderable per MIL-STD-202, Method 208 guaranteed
- ✧ Polarity: Indicated by cathode band
- ✧ Packaging: 12mm tape per EIA STD RS-481
- ✧ Weight: 0.07 gram

Ordering Information (example)

Part No.	Package	Packing	Packing code	Green Compound Packing code
SK32A	SMA	1.8K / 7" REEL	R3	R3G

Maximum Ratings and Electrical Characteristics

Rating at 25 °C ambient temperature unless otherwise specified.

Single phase, half wave, 60 Hz, resistive or inductive load.

For capacitive load, derate current by 20%

Type Number	Symbol	SK 32A	SK 33A	SK 34A	SK 35A	SK 36A	SK 39A	SK 310A	SK 315A	SK 320A	Unit	
Maximum Repetitive Peak Reverse Voltage	V_{RRM}	20	30	40	50	60	90	100	150	200	V	
Maximum RMS Voltage	V_{RMS}	14	21	28	35	42	63	70	105	140	V	
Maximum DC Blocking Voltage	V_{DC}	20	30	40	50	60	90	100	150	200	V	
Maximum Average Forward Rectified Current	$I_{F(AV)}$	3									A	
Peak Forward Surge Current, 8.3 ms Single Half Sine-wave Superimposed on Rated Load	I_{FSM}	70									A	
Maximum Instantaneous Forward Voltage (Note 1) @ 3 A	V_F	0.55			0.75		0.85		0.95		V	
Maximum Reverse Current @ Rated VR $T_A=25^\circ\text{C}$ $T_A=100^\circ\text{C}$ $T_A=125^\circ\text{C}$	I_R	0.5					0.1					mA
		10			5.0		-					
		-					0.5					
Typical Junction Capacitance (Note 2)	C_j	600			290		110					pF
Typical Thermal Resistance	$R_{\theta JL}$	28									°C/W	
	$R_{\theta JA}$	88										
Operating Temperature Range	T_J	- 65 to + 150									°C	
Storage Temperature Range	T_{STG}	- 65 to + 150									°C	

Note 1: Pulse Test with PW=300 usec, 1% Duty Cycle

Note 2: Measure at 1 MHz and Applied Reverse Voltage of 4.0V D.C.

RATINGS AND CHARACTERISTIC CURVES (SK32A THRU SK320A)

FIG. 1 FORWARD CURRENT DERATING CURVE

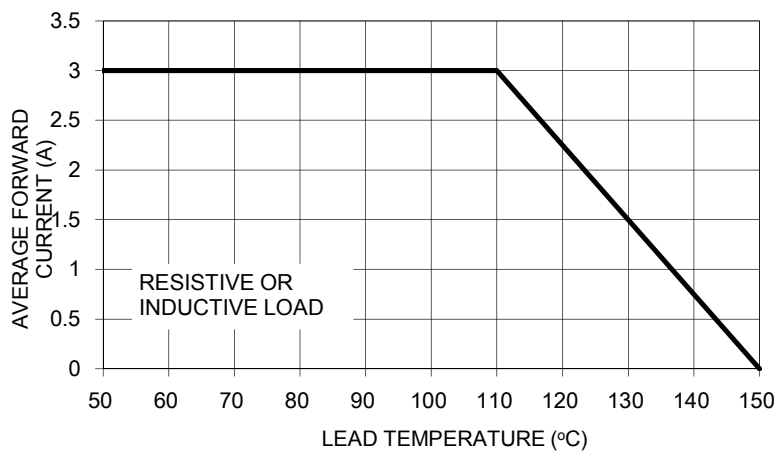

FIG. 2 MAXIMUM NON-REPETITIVE FORWARD SURGE CURRENT

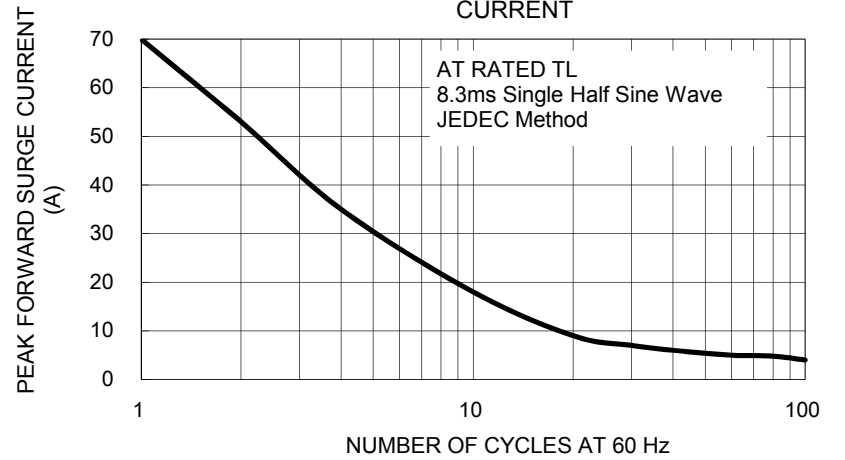

FIG. 3 TYPICAL FORWARD CHARACTERISTICS

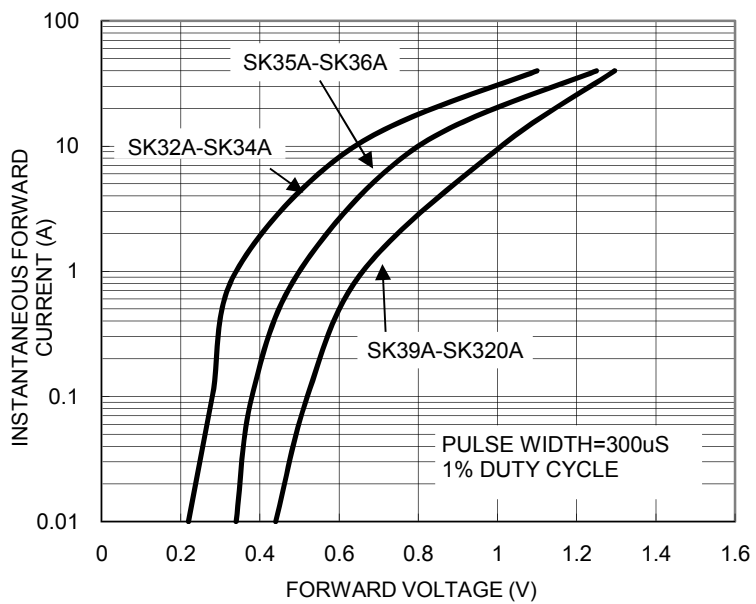

FIG. 4 TYPICAL REVERSE CHARACTERISTICS

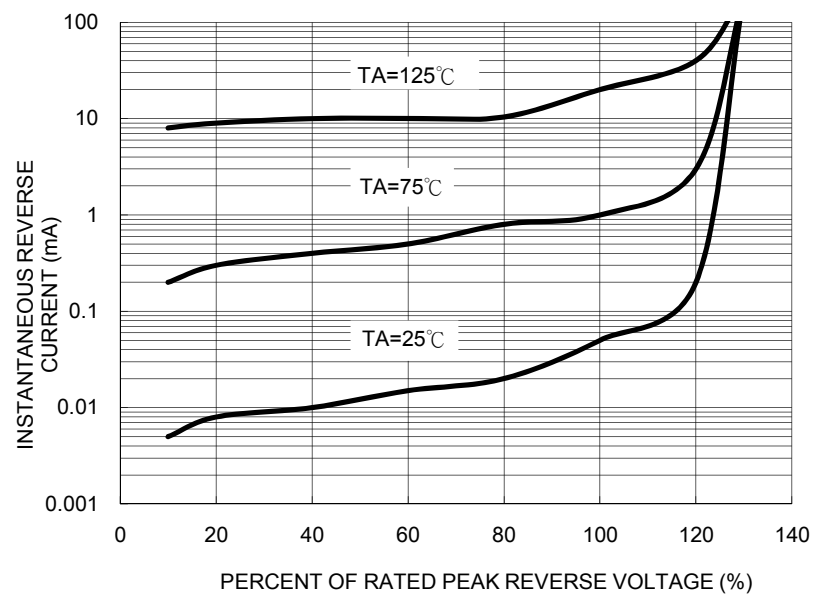

FIG. 5 TYPICAL JUNCTION CAPACITANCE

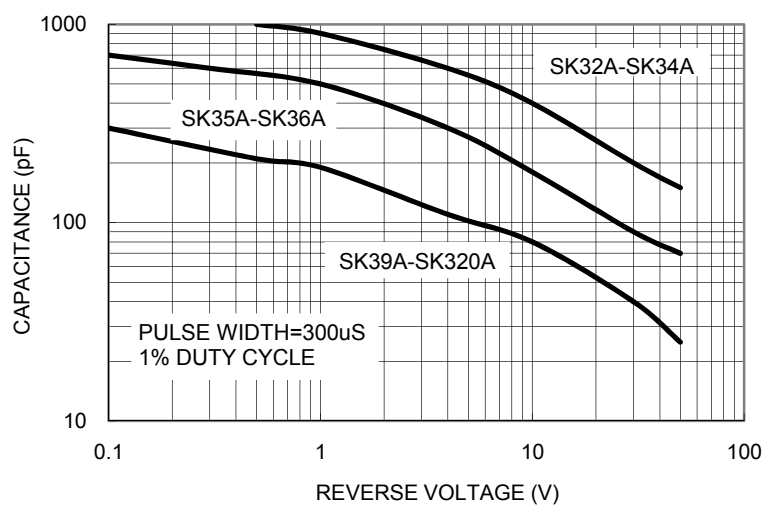
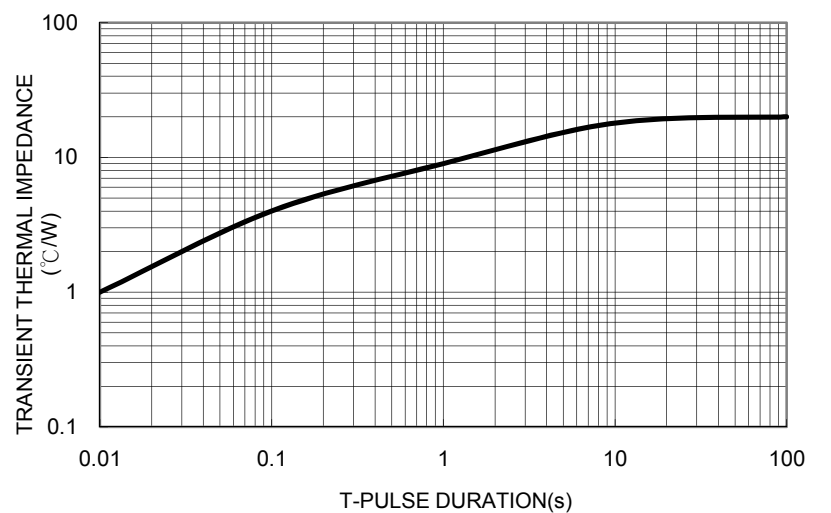

FIG. 6 TYPICAL TRANSIENT THERMAL IMPEDANCE



Ordering information

Part No.	Package	Packing	Packing code	Green Compound Packing code
SK3XA (Note)	SMA	1.8K / 7" REEL	R3	R3G
	SMA	7.5K / 13" REEL	R2	R2G
	SMA	7.5K / 13" REEL	M2	M2G
	Folded SMA	1.8K / 7" REEL	F3	F3G
	Folded SMA	7.5K / 13" REEL	F2	F2G
	Folded SMA	7.5K / 13" REEL	F4	F4G
	C SMA	1.8K / 7" REEL	E3	E3G
	C SMA	7.5K / 13" REEL	E2	E2G

Note: "x" is Device Code from "2" thru "20".

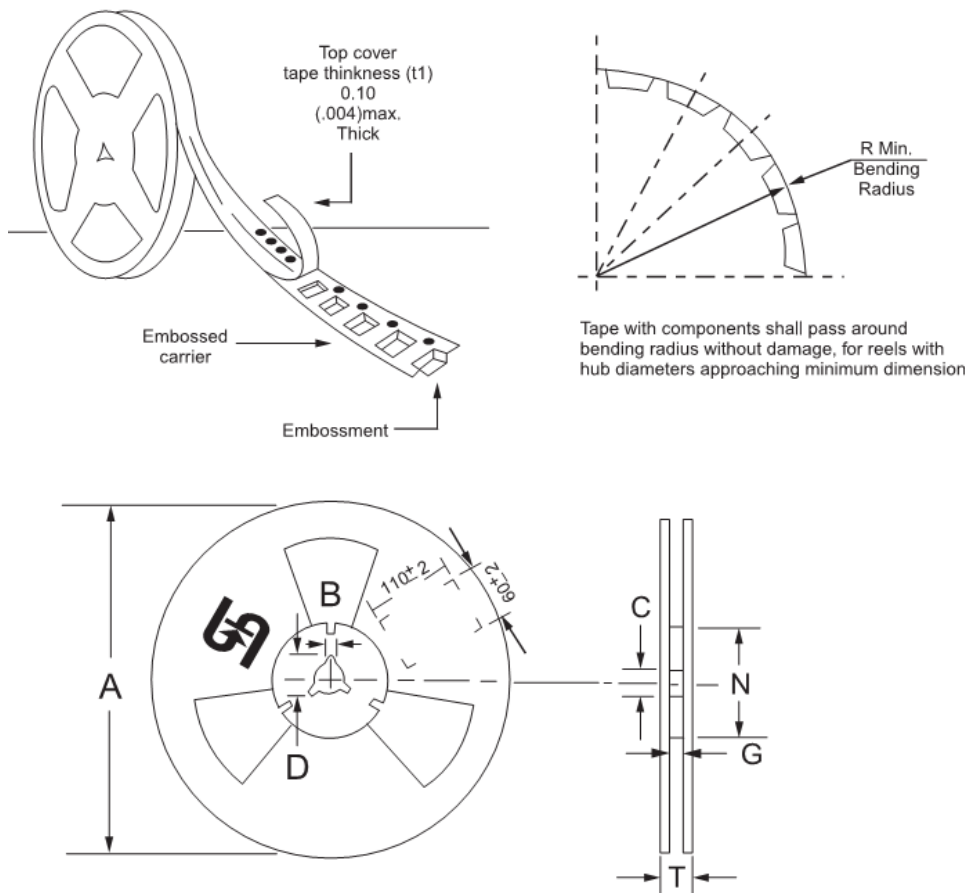
Tape & Reel specification

Reel Size	Tape Size	A	B	C	D	N	G	T
		± 2.0	± 0.4	$+0.5; -0.2$	min	± 1.0	$+0.8; -0$	max
7"	12mm	178	1.9	13	21	62	12.2	14.6
		A	B	C	D	N	G	T
		max	± 0.5	± 0.5	min	± 0.5	$+2.0; -0$	max
13"	12mm	330	2	13	20.2	75	12.4	18.4

Unit (mm)

Suggested PAD Layout

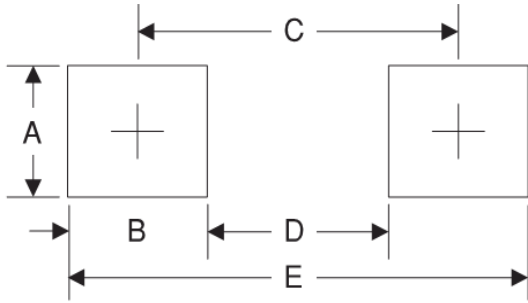

Symbol	Unit(mm)
A	1.78
B	1.51
C	3.92
D	2.41
E	4.43

Package Outline Dimensions

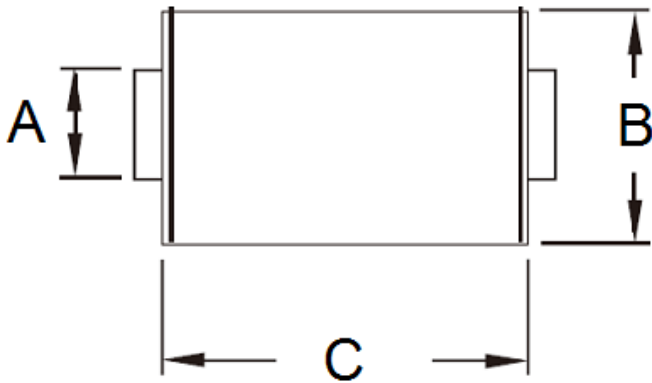

DIM.	Unit(mm)		Unit(inch)	
	Min	Max	Min	Max
A	1.27	1.58	0.050	0.062
B	2.29	2.83	0.090	0.111
C	4.06	4.60	0.160	0.181
D	1.99	2.50	0.078	0.098
E	0.90	1.41	0.035	0.056
F	0.15	0.31	0.006	0.012
G	0.10	0.20	0.004	0.008
H	4.95	5.33	0.195	0.210

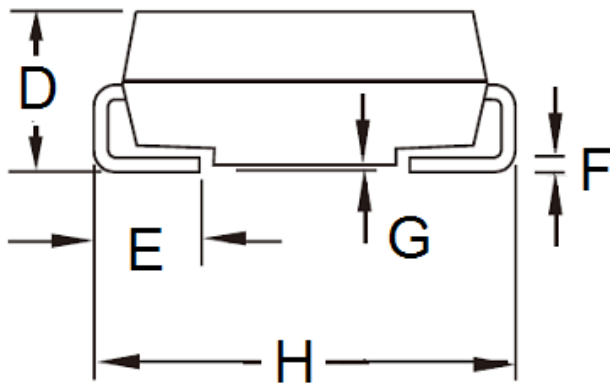

Marking Diagram

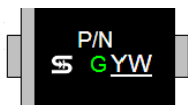

P/N = Specific Device Code
 G = Green Compound
 YW = Date Code