

POWER SYSTEMS SPECIAL POWER SUPPLY LH(E) SERIES

5-25W, AC-DC CONVERTER

LH(E) series ----is a compact size power converter offered by Mornsun for PCB mount installation applications. It features universal input voltage, taking both DC and AC input voltage, low power consumption, high efficiency, high reliability, safer isolation. It offers good EMC performance, meets IEC61000 standards, inrush current meets level 4 standards, and widely used in power systems applications.



RoHS

PRODUCT FEATURES

1. Universal Input :85 ~ 264VAC,50/60Hz
2. Regulated output, low ripple and noise
3. Low power consumption, high efficiency
4. output short circuit protection, over-current protection and thermal protection
5. UL94V-0; plastic case, meets
6. CLASS II ,safety grade
7. EMC , meets IEC61000
8. Three years warranty

MODEL SELECTION

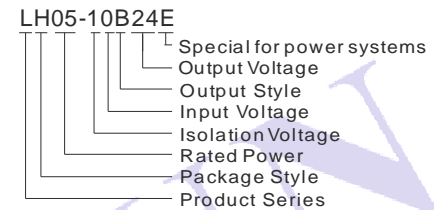

PRODUCT PROGRAM

Model	Package	Power	Output (Vo1/Io1)	Output (Vo2/Io2)	Ripple and Noise (Typ.)	Efficiency (%) (Typ.)
LH05-10B09E	48.5X36X20.5mm	5W	9V/550mA		50mV	76
LH05-10B24E			24V/230mA			79
LH05-10D0524-01E			5V/600mA	24V/100mA		75
LH10-10B12E	55X45X21.0mm	10W	12V/900mA			79
LH10-10B15E			15V/700mA			80
LH10-10D0505-02E			5V/1800mA	5V/200mA		75
LH10-10D0524-02E			5V/1000mA	24V/200mA		79
LH15-10B12E	62x45x22.5mm	15W	12V/1250mA			80
LH15-10D0524-02E			5V/2000mA	24/200mA		80
LH25-10B12E	70x48x23.5mm	25W	12V/2100mA			81
LH25-10B24E			24V/1100mA		83	

Note :

1. Ripple and Noise were measured by the method of parallel lines;
2. Unless otherwise specified, all specifications above are measured at rated input voltage and rated output load, Ta=25oC, humidity < 75%;
3. All specifications stated in this datasheet are subject to the above listed models only. For specifications of non-standard models, please contact our technical support team.

INPUT SPECIFICATIONS

Input voltage range		85 ~ 264VAC, 120 ~ 370VDC	
Input frequency		47 ~ 63Hz	
Input current	LH05 models LH10 models LH15 models LH25 models	110VAC 120mA , typ. 230mA , typ. 250mA , typ. 420mA , typ.	230VAC 70mA , typ. 120mA , typ. 140mA , typ. 230mA , typ.
Inrush current	LH05 models LH10 models LH15 models LH25 models	110VAC 10A, typ. 10A, typ. 10A, typ. 16A, typ.	230VAC 20A, typ. 20A, typ. 20A, typ. 30A, typ.
Leakage current		0.3mA RMS typ. 230VAC/50Hz	
External input fuse(recommended)	LH05 models LH10/LH15 models LH25 models	1A/250V slow blow 2A/250V slow blow 3.15A/250V slow blow	

OUTPUT SPECIFICATIONS

Voltage set accuracy		±2% (main output)	
Input variation		±0.5% (main output) ±1.5% (supplement output)	
Load variation (10-100%)	Single output models	±1%	
	Isolated and separated twin output (balanced load)	Vo1: ±3% (main output) Vo2: ±5% (supplement output)	
Minimum load	single output models Isolated and separated twin output	0% 10% (main output)	
Ripple & noise(p-p) (main output)	(20MHz Bandwidth)	50mV (Typ.)	100mV (Max.)
Short circuit protection		Continuous, and auto resume	
Over current protection		≥110% I _o	
Over output voltage protection	5VDC models 9VDC models 12 / 15VDC models 24VDC models	≤7.5VDC ≤12VDC ≤20VDC ≤30VDC	

COMMON SPECIFICATIONS

Temperature ranges	Operating : Power derating Storage: Case temperature:	above 55°C:	-40°C ~ +70°C 3.75% / °C -40°C ~ +105°C +90°C (Max)
Hold-up time	(Vin=230VAC)		80ms (Typ.)
Humidity(non condensing)			85% (Max.)
Temperature coefficient			0.02%/°C (main output) 0.15%/°C (supplement output)
Switching frequency			65kHz (Typ.)
I/O-isolation voltage			3000VAC/1Min
EMC compliance	EMI	RE CE	CISPR22/EN55022 CLASS B CISPR22/EN55022 CLASS B
	EMS	ESD RS EFT Surge CS PFM Voltage dips、 short and interruptions immunity	IEC/EN61000-4-2 Air ±8KV / Contact ±6KV perf. Criteria B IEC/EN61000-4-3 10V/m perf. Criteria A IEC/EN61000-4-4 ±4KV perf. Criteria B IEC/EN61000-4-5 ±2KV perf. Criteria B IEC/EN61000-4-6 10 Vr.m.s perf. Criteria A IEC/EN61000-4-8 10A/m perf. Criteria A IEC/EN61000-4-11 0%-70% perf. Criteria B
Safety Class			CLASS II
Case material			UL 94V-0
Install			PCB
MTBF			>300,000h @25°C
Package	LH05 models LH10 models LH15 models LH25 models		48.5x36x20.5mm 55x45x21mm 62x45x22.5mm 70x48x23.5mm
Note: The indicators of EMC compliance are higher than EN55024 standard.			

TYPICAL APPLICATIONS

LH**-10B**E(Single Output) (figure 1)

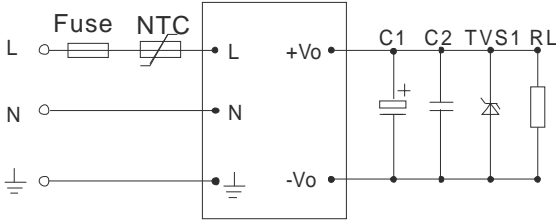

LH**-10D**E(Isolate Twin Output) (figure 2)

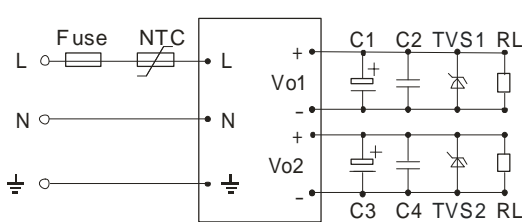

LH**-10***E series if higher requirement to EMC application circuit (external circuit output as above typical applications) (figure 3):

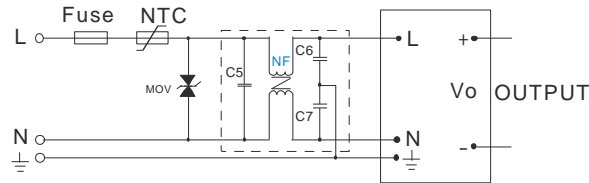

EXTERNAL CAPACITORS TYPICAL VALUE(Unit: mF)

MODEL	C1	C3	TVS1	TVS2	MODEL	C1	C3	TVS1	TVS2
LH05-10B09E	120		P6KE12A		LH10-10B12E	120		P6KE20A	
LH05-10B24E	68		P6KE30A		LH10-10B15E	120		P6KE20A	
LH05-10D0524-01	120	22	P6KE6.8A	P6KE30A	LH10-10D0505-02E	220	68	P6KE6.8A	P6KE6.8A
LH15-10B12E	220		P6KE20A		LH10-10D0524-02E	220	47	P6KE6.8A	P6KE30A
LH25-10B12E	330		P6KE20A		LH15-10D0524-02E	470	47	P6KE6.8A	P6KE30A
LH25-10B24E	120		P6KE30A						

Note:

- Output filtering capacitors C1, C3 are electrolytic capacitors, It is recommended to use high frequency and low impedance electrolytic capacitors. For capacitance and current of capacitor please refer to manufacture's datasheet. Voltage derating of capacitor should be 80% or above. C2,C4 are use to filter high frequency noise, suggest choose 0.1 μ F. TVS is recommended component to protect post-circuits (if converter fails).
- External input NTC is recommended to use 5D-9 (Only LH10 models and LH15 models)
- Module recommended external varistor, model: S10K550.
- If common requirement to EMC performance, refer to figure 1& figure 2, if higher requirement to EMC performance, refer to figure 3.
 C5:X capacitor, recommended parameter 0.1 μ F /275V;
 C6,C7:Y capacitor, recommended parameter 2200pF/400V;
 NF: common model choke, recommended inductance is about 10mH-30mH.

TYPICAL EFFICIENCY CURVE

Load VS Efficiency curve (Vi=220Vac)

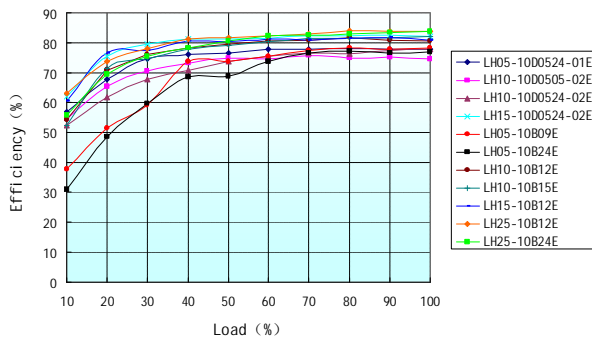

Input vol tage VS Efficiency curve(Load=100%)

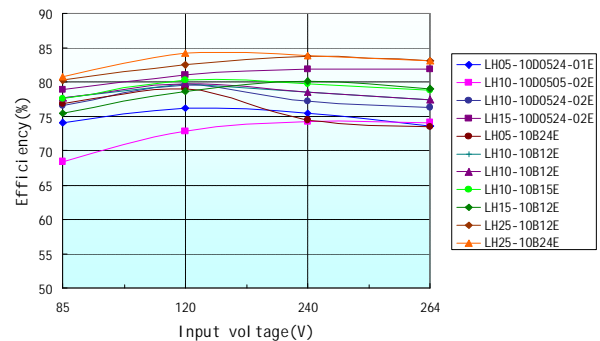

INPUT VOLTAGE VS LOAD

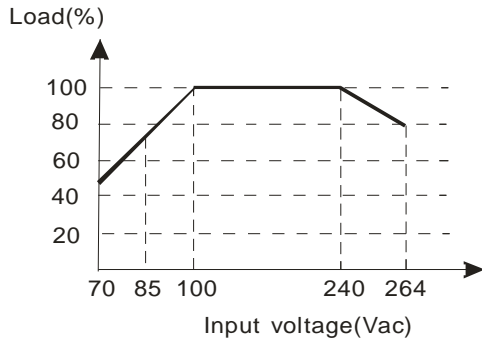

*Note: When input DC, $V_{dc}=1.414V_{ac}-20V_{dc}$.

TEMPERATURE VS LOAD

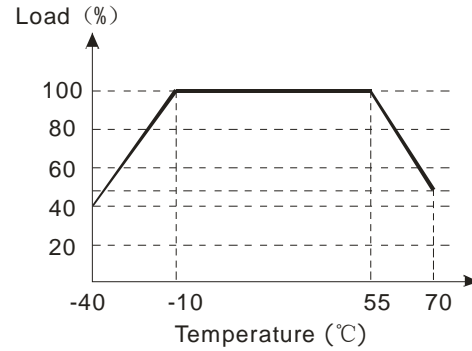

PARALLEL LINES MEASURE

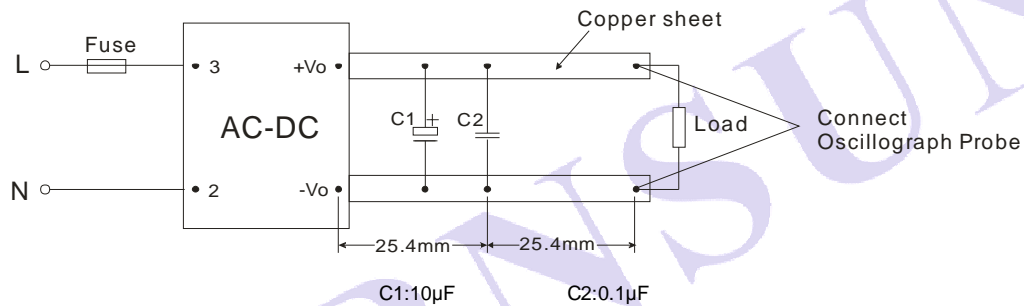

TRIM APPLICATION & TRIM CALCULATION

Application circuit for TRIM
(Part in broken line is the interior of models)

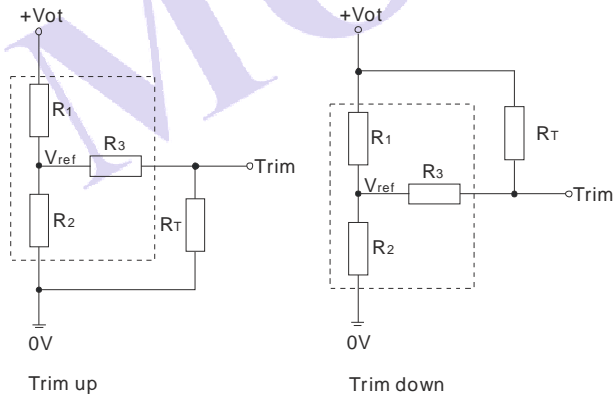

Formula for resistance of Trim

$$\text{up: } R_T = \frac{aR_2}{R_2 - a} - R_3 \quad a = \frac{V_{ref}}{V_{ot} - V_{ref}} \cdot R_1$$

$$\text{down: } R_T = \frac{aR_1}{R_1 - a} - R_3 \quad a = \frac{V_{ot} - V_{ref}}{V_{ref}} \cdot R_2$$

Note: Value for R1, R2, R3, and Vref refer to the following table.
 R_T : Resistance of Trim

a: User-defined parameter, no actual meanings.

	$V_o(V)$	12	24
Resistance			
$R_1(K\Omega)$		3.83	8.66
$R_2(K\Omega)$		1	1
$R_3(K\Omega)$		1	1
$V_{ref}(V)$		2.5	2.5
$V_{ot}(V)$		Output voltage of Trim, variation $\leq \pm 10\%$	

OUTLINE AND DIMENSIONS

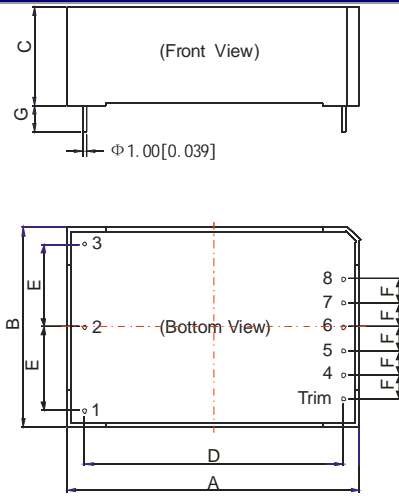

Note:
Unit:mm[inch]
Pin diameter tolerances:±0.10mm[±0.004inch]
General tolerances:±0.50mm[±0.020inch]

LH05 series

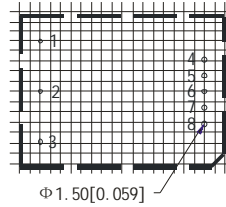

LH10 series

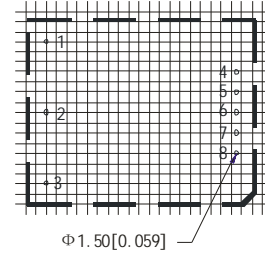

LH15 series

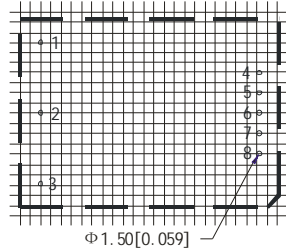

LH25 series

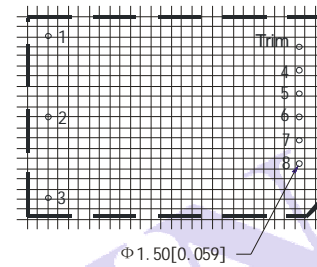

Note: grid 2.54*2.54mm.

OUTLINE AND DIMENSIONS (Unit: mm)				
NO.	LH05	LH10	LH15	LH25
A	48.50	55.00	62.00	70.00
B	36.00	45.00	45.00	48.00
C	20.50	21.00	22.50	23.50
D	40.50	47.00	54.00	62.00
E	12.50	17.50	17.50	20.00
F	4.00	5.00	5.00	5.75
G	10.00	12.50	12.50	12.50
I	4.00	4.00	4.00	4.00

MODLES WEIGHT				
WEIGHT	LH05	LH10	LH15	LH25
(Typ.)	50g	70g	80g	120g

FOOTPRINT DETAILS		
Pin	LHXX-10B	LHXX-10D
1		
2	AC(N)	AC(N)
3	AC(L)	AC(L)
4	-Vo	-Vo1
5	No Pin	+Vo1
6	No Pin	No Pin
7	No Pin	-Vo2
8	+Vo	+Vo2
Trim	Trim**	No Pin

There is no pin "1" on LH15-10BXXE
Trim**: only for LH25-10BXXE Series.

PACKAGE DIAGRAM



(Other Series)

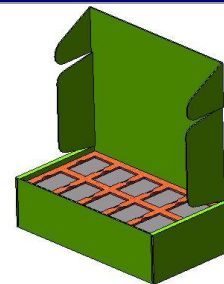

Inner packaging box dimensions: L*W*H=355*192*93mm
Outer packaging box dimensions: L*W*H=405*380*305mm

Packaging quantity: 20pcs (LH05 series: 40pcs)
Packaging quantity: 120pcs (LH05 series: 240pcs)

MORNSUN Science & Technology Co., Ltd.

Address: No. 5, Kehui St. 1, Kehui development center, Science Ave., Guangzhou Science City, Luogang district, Guangzhou, P.R. China.

Tel: 86-20-38601850

Fax: 86-20-38601272

[Http://www.mornsun-power.com](http://www.mornsun-power.com)