



Lead Free SMD Resettable Fuse

Document No	TRF18OS002A
Issued date	2011/08/15
Page	1/8

1. Scope

This specification applies for the Lead-Free SMD Resettable fuse series .

2. Construction

Style 1



Style 2

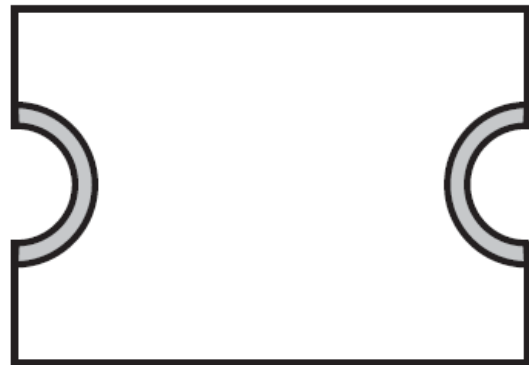

Terminal material:
Electroless Ni under immersion Au

Termination pad solderability:
Standard Au finish:
Meets ANSI/J-STD-002 Category 2.

3. Type Designation

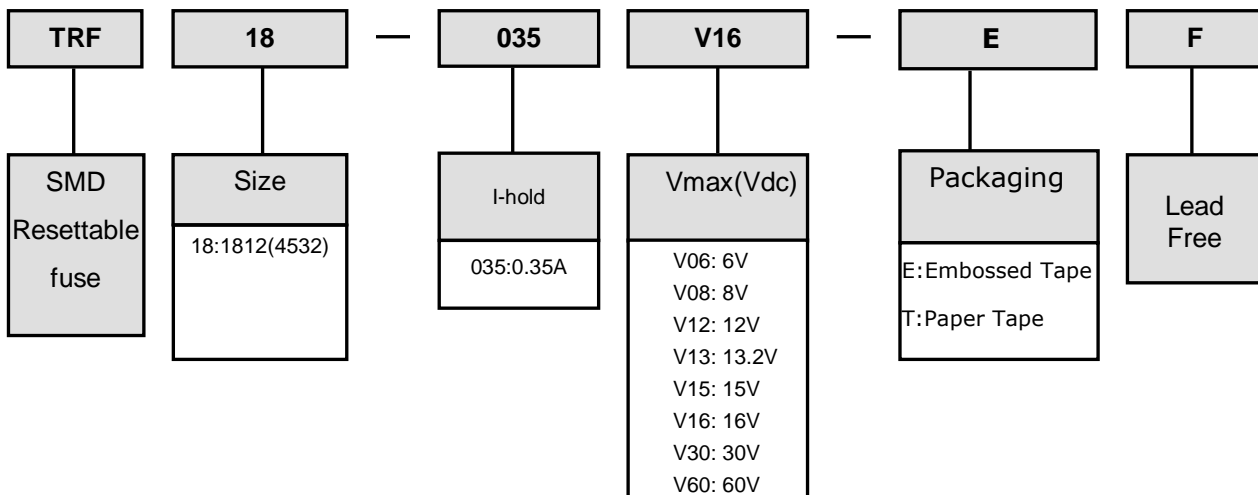



Lead Free SMD Resettable Fuse

Document No	TRF18OS002A
Issued date	2011/08/15
Page	2/8

4. Dimensions

Style 1

Top and Bottom View

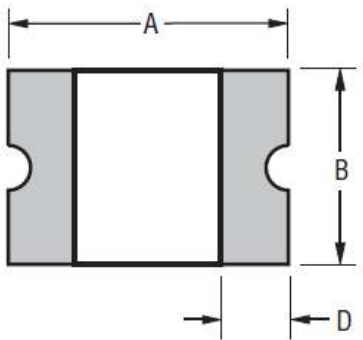

Side View

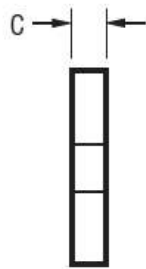

Recommended Pad Layout

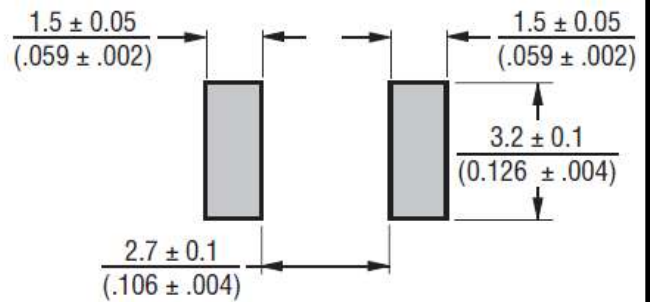

Style 2

Top View

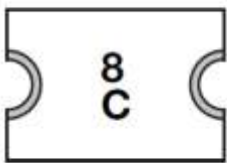

Bottom View

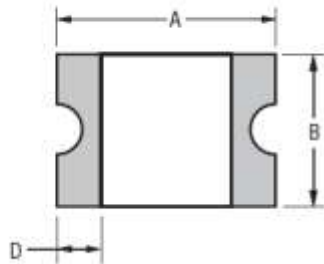

Side View

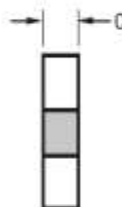

Recommended Pad Layout

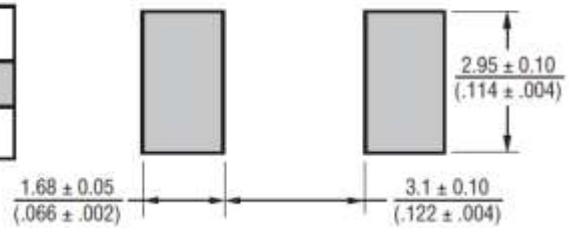



Lead Free SMD Resettable Fuse

Document No	TRF18OS002A
Issued date	2011/08/15
Page	3/8

Dimensions

Unit: mm

Part Designation	A		B		C		D	Style
	Min.	Max.	Min.	Max.	Min.	Max.	Min.	
TRF18-010V60-EF	4.37	4.73	3.07	3.41	0.70	1.10	0.30	1
TRF18-014V60-EF	4.37	4.73	3.07	3.41	0.70	1.10	0.30	1
TRF18-020V30-EF	4.37	4.73	3.07	3.41	0.70	1.10	0.30	1
TRF18-020V60-EF	4.37	4.73	3.07	3.41	0.70	1.10	0.30	1
TRF18-030V30-EF	4.37	4.73	3.07	3.41	0.70	1.10	0.30	1
TRF18-050V15-EF	4.37	4.73	3.07	3.41	0.55	0.85	0.30	1
TRF18-075V13-EF	4.37	4.73	3.07	3.41	0.55	0.85	0.30	1
TRF18-075V24-EF	4.37	4.73	3.07	3.41	0.55	0.85	0.30	1
TRF18-110V06-EF	4.37	4.73	3.07	3.41	0.45	0.85	0.30	1
TRF18-110V16-EF	4.37	4.73	3.07	3.41	0.45	0.85	0.30	1
TRF18-110V24-EF	4.37	4.83	3.07	3.41	0.70	1.60	0.30	2
TRF18-125V06-EF	4.37	4.73	3.07	3.41	0.55	0.85	0.30	1
TRF18-150V06-EF	4.37	4.73	3.07	3.41	0.55	0.85	0.30	1
TRF18-150V24-EF	4.37	4.83	3.07	3.41	0.70	1.60	0.30	2
TRF18-160V08-EF	4.37	4.73	3.07	3.41	0.55	0.85	0.30	1
TRF18-200V08-EF	4.37	4.73	3.07	3.41	0.55	0.85	0.30	1
TRF18-250V16-EF	4.37	4.83	3.07	3.41	0.70	1.60	0.30	2
TRF18-260V06-EF	4.37	4.73	3.07	3.41	0.48	0.85	0.30	1

Packaging:

TRF18-010V60-EF through TRF18-030V30-EF = 1500 pcs. per reel.

TRF18-050V15-EF through TRF18-200V08-EF & TRF18-260V06-EF = 2000 pcs. per reel.

TRF18-110V24-EF = 1000 pcs. per reel.

TRF18-150V24-EF & TRF18-250V16-EF = 1500 pcs. per reel.



Lead Free SMD Resettable Fuse

Document No	TRF18OS002A
Issued date	2011/08/15
Page	4/8

5. Applications and ratings

Part Designation	V _{max} (Vdc)	I _{max} (A)	I _{hold} at 23°C (A)	I _{trip} at 23°C (A)	P _d Typ. (W)	Maximum time to trip at 23°C		Resistance at 23°C	
						Current (A)	Time (Sec)	R _{i min} (Ω)	R _{1 max} (Ω)
TRF18-010V60-EF	60.0	40	0.10	0.30	0.8	0.5	1.50	0.70	15.00
TRF18-014V60-EF	60.0	40	0.14	0.34	0.8	1.5	0.15	0.40	6.5
TRF18-020V30-EF	30.0	80	0.20	0.40	0.8	6.0	0.06	0.40	6.00
TRF18-020V60-EF	60.0	40	0.20	0.40	0.8	1.5	0.15	0.40	6
TRF18-030V30-EF	30.0	10	0.30	0.60	0.8	8.0	0.10	0.30	3
TRF18-050V15-EF	15.0	100	0.50	1.00	0.8	8.0	0.15	0.15	1
TRF18-075V13-EF	13.2	100	0.75	1.50	0.8	8.0	0.20	0.11	0.45
TRF18-075V24-EF	24.0	40	0.75	1.5	0.8	8.0	0.20	0.11	0.45
TRF18-110V06-EF	6.0	100	1.10	2.2	0.8	8.0	0.30	0.04	0.21
TRF18-110V16-EF	16.0	100	1.10	2.2	0.8	8.0	0.30	0.04	0.21
TRF18-110V24-EF	24.0	20	1.10	2.2	0.8	8.0	0.50	0.06	0.18
TRF18-125V06-EF	6.0	100	1.25	2.5	0.8	8.0	0.40	0.035	0.14
TRF18-150V06-EF	6.0	100	1.50	3	0.8	8.0	0.5	0.03	0.12
TRF18-150V24-EF	24.0	20	1.50	3	1.0	8.0	1.5	0.03	0.12
TRF18-160V08-EF	8.0	100	1.60	2.8	0.8	8.0	2.0	0.035	0.099
TRF18-200V08-EF	8.0	40	2.00	4	0.8	8.0	3.0	0.020	0.08
TRF18-250V16-EF	16.0	100	2.50	5	1.2	8.0	5.0	0.015	0.1
TRF18-260V06-EF	6.0	100	2.60	5.2	0.8	8.0	5.0	0.015	0.08

I_{hold} = Hold Current. Maximum current device will sustain for 30min without tripping in 23°C still air.
I_{trip} = Trip Current. Minimum current at which the device will trip in 23°C still air.
V_{max} = Maximum voltage device can withstand without damage at rated current.
I_{max} = Maximum fault current device can withstand without damage at rated voltage.
P_d = Power dissipated from device when in the tripped state at 23°C still air.
R_{i min} = Typical resistance of device in initial (un-soldered) state.
R_{1 max} = Maximum resistance of device at 23°C measured one hour post reflow.
CAUTION: Operation beyond the specified ratings may result in damage and possible arcing and flame.



Lead Free SMD Resettable Fuse

Document No	TRF18OS002A
Issued date	2011/08/15
Page	5/8

6. Thermal Derating Chart

Part Designation	Maximum ambient operating temperature(T_{mao}) vs. hold current (I_{hold}) (Amps)								
	-40°C	-20°C	0°C	23°C	40°C	50°C	60°C	70°C	85°C
TRF18-010V60-EF	0.16	0.14	0.12	0.10	0.08	0.07	0.06	0.05	0.03
TRF18-014V60-EF	0.23	0.19	0.17	0.14	0.12	0.10	0.09	0.08	0.06
TRF18-020V30-EF	0.29	0.26	0.23	0.20	0.17	0.15	0.14	0.12	0.10
TRF18-020V60-EF	0.29	0.26	0.23	0.20	0.17	0.15	0.14	0.12	0.10
TRF18-030V30-EF	0.44	0.39	0.35	0.30	0.26	0.23	0.21	0.18	0.15
TRF18-050V15-EF	0.77	0.68	0.59	0.50	0.44	0.40	0.37	0.33	0.29
TRF18-075V13-EF	1.15	1.01	0.88	0.75	0.65	0.60	0.55	0.49	0.43
TRF18-075V24-EF	1.15	1.01	0.88	0.75	0.65	0.60	0.55	0.49	0.43
TRF18-110V06-EF	1.59	1.43	1.26	1.10	0.95	0.87	0.80	0.71	0.60
TRF18-110V16-EF	1.59	1.43	1.26	1.10	0.95	0.87	0.80	0.71	0.60
TRF18-110V24-EF	2.00	1.70	1.40	1.10	0.95	0.88	0.80	0.73	0.61
TRF18-125V06-EF	1.80	1.63	1.43	1.25	1.08	0.99	0.91	0.81	0.68
TRF18-150V06-EF	2.17	1.95	1.72	1.50	1.30	1.18	1.09	0.97	0.82
TRF18-150V24-EF	2.10	1.90	1.70	1.50	1.25	1.13	1.00	0.88	0.69
TRF18-160V08-EF	2.30	2.20	1.90	1.60	1.45	1.30	1.15	1.03	0.91
TRF18-200V08-EF	3.08	2.71	2.35	2.00	1.80	1.60	1.50	1.40	1.25
TRF18-250V16-EF	3.85	3.45	3.00	2.50	2.05	1.85	1.75	1.30	1.10
TRF18-260V06-EF	4.00	3.52	3.06	2.60	2.34	2.08	1.95	1.39	1.04

7. Typical Time to Trip at 23 °C

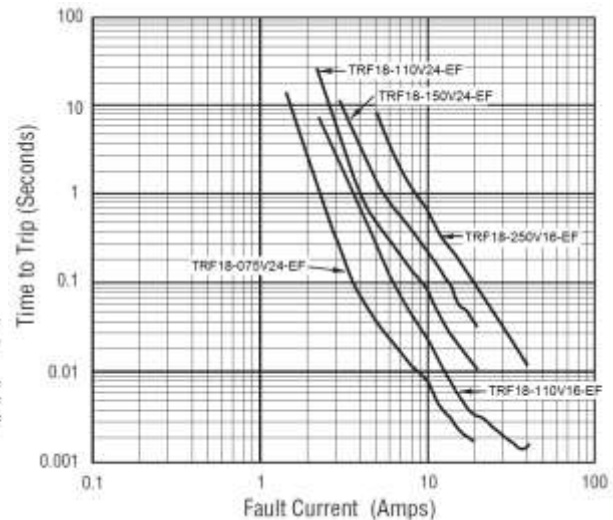
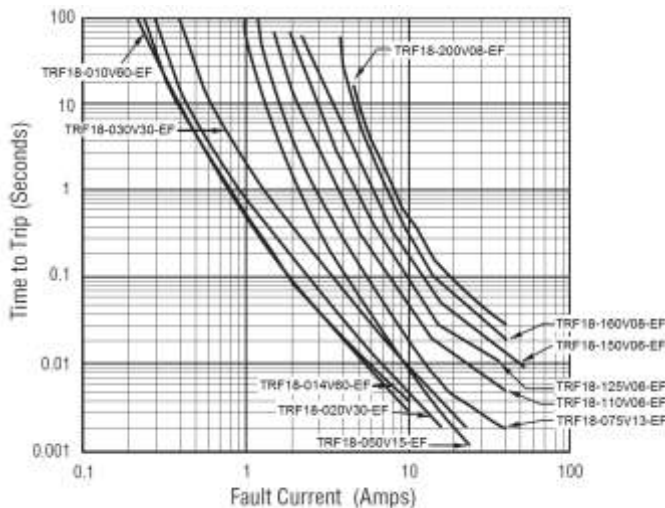

The Time to Trip curves represent typical performance of a device in a simulated application environment. Actual performance in specific customer applications may differ from these values due to the influence of other variables.



Lead Free SMD Resettable Fuse

Document No	TRF18OS002A
Issued date	2011/08/15
Page	6/8

8. Environment

8.1 Operating Conditions

Operating Temperature: -40°C to 85°C

Device Surface Temperature in Tripped State: 125°C max

8.2 Environmental Specifications

TEST ITEM	Condition	Resistance Change
Passive aging	85°C,1000hr	±5% typical
Humidity aging	85°C,85%R.H,1000hr	±5% typical
Thermal shock	85°C to -40°C,20times	±10% typical
Resistance to solvent	MIL-STD-202,Method215	No change
Vibration	MIL-STD-883C,Method2007.1 Condition A	No change

8.3 Solder Reflow Recommendations

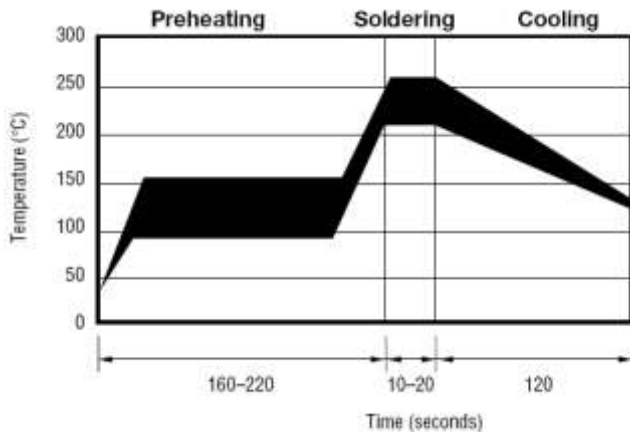

- Recommend reflow methods : IR, vapor phase oven, hot air oven.
 - Devices are not designed to be wave soldered to the bottom side of the board.
 - Recommended maximum paste thickness is 0.25 mm(0.010 inch).
 - Devices can be cleaned using standard method and solvents.
- Note : If reflow temperatures exceed the recommended profile, devices may not meet the performance requirements.



Lead Free SMD Resettable Fuse

Document No	TRF18OS002A
Issued date	2011/08/15
Page	7/8

9. Typical Part Marking

Style 1 :

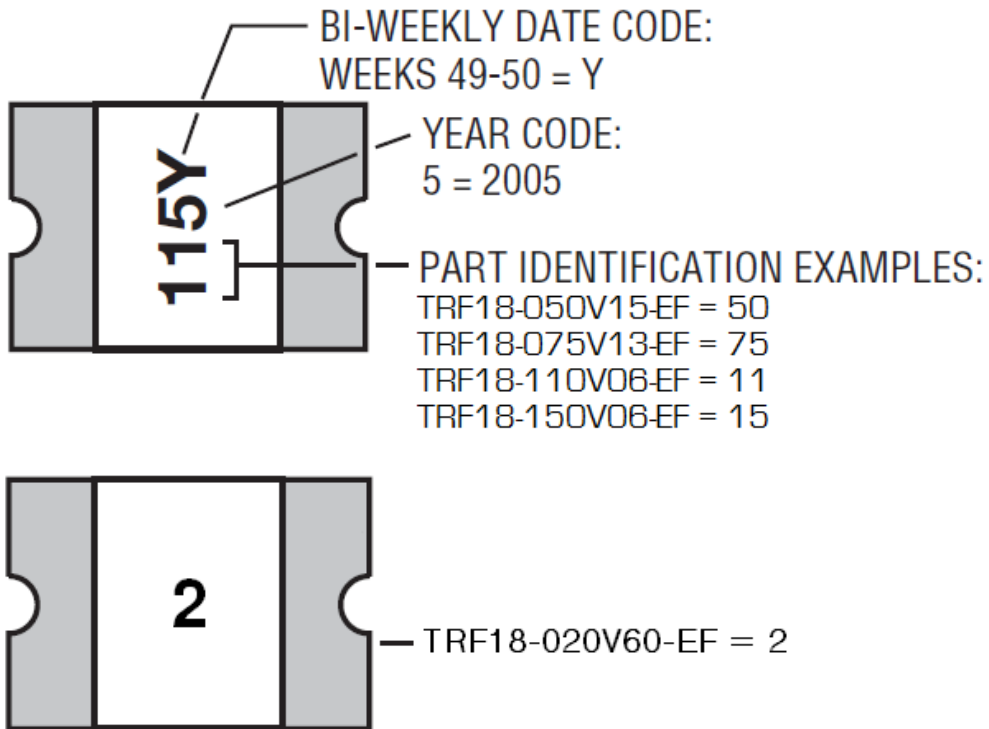

Style 2 :

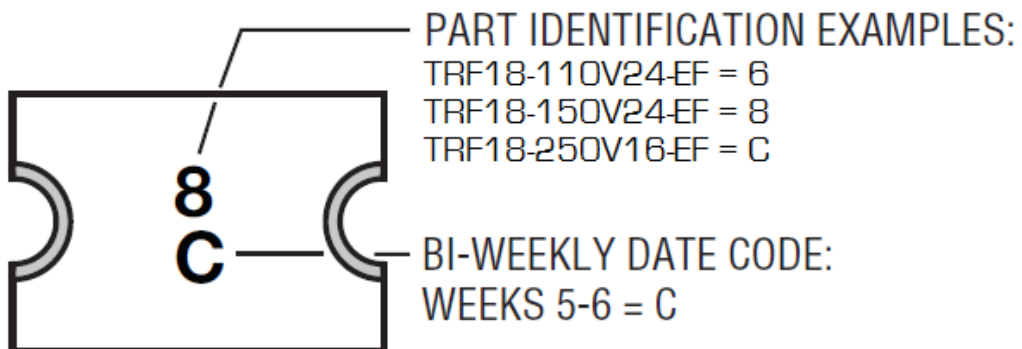



Lead Free SMD Resettable Fuse

Document No	TRF18OS002A
Issued date	2011/08/15
Page	8/8

10. Taping & Reel

Tape Dimensions	TRF18-010 ~ TRF18-030	TRF18-050 ~ TRF18-260	TRF18-110V24 TRF18-150V24 TRF18-250V16
	per EIA-481-1	per EIA 481-1	per EIA 481-1
W	12.0 ± 0.30 (0.472 ± 0.012)	12.0 ± 0.30 (0.472 ± 0.012)	12.0 ± 0.30 (0.472 ± 0.012)
P ₀	4.0 ± 0.10 (0.157 ± 0.004)	4.0 ± 0.10 (0.157 ± 0.004)	4.0 ± 0.10 (0.157 ± 0.004)
P ₁	8.0 ± 0.10 (0.315 ± 0.004)	8.0 ± 0.10 (0.315 ± 0.004)	8.0 ± 0.10 (0.315 ± 0.004)
P ₂	2.0 ± 0.05 (0.079 ± 0.002)	2.0 ± 0.05 (0.079 ± 0.002)	2.0 ± 0.05 (0.079 ± 0.002)
A ₀	3.58 ± 0.10 (0.141 ± 0.004)	3.66 ± 0.15 (0.144 ± 0.006)	3.70 ± 0.10 (0.146 ± 0.004)
B ₀	4.93 ± 0.10 (0.194 ± 0.004)	4.98 ± 0.10 (0.196 ± 0.004)	5.10 ± 0.10 (0.200 ± 0.004)
B ₁ max.	5.9 (0.232)	5.9 (0.232)	5.9 (0.232)
D ₀	$1.5 + 0.10/-0.0$ $(0.059 + 0.004/-0)$	$1.5 + 0.10/-0.0$ $(0.059 + 0.004/-0)$	$1.5 + 0.10/-0.0$ $(0.059 + 0.004/-0)$
F	5.5 ± 0.05 (0.217 ± 0.002)	5.5 ± 0.05 (0.217 ± 0.002)	5.5 ± 0.05 (0.217 ± 0.002)
E ₁	1.75 ± 0.10 (0.069 ± 0.004)	1.75 ± 0.10 (0.069 ± 0.004)	1.75 ± 0.10 (0.069 ± 0.004)
E ₂ min.	10.25 (0.404)	10.25 (0.404)	10.25 (0.404)
T max.	0.6 (0.024)	0.6 (0.024)	0.6 (0.024)
T ₁ max.	0.1 (0.004)	0.1 (0.004)	0.1 (0.004)
K ₀	1.30 ± 0.10 (0.051 ± 0.004)	0.95 ± 0.10 (0.037 ± 0.004)	1.50 ± 0.10 (0.059 ± 0.004)
Leader min.	390 (15.35)	390 (15.35)	390 (15.35)
Trailer min.	160 (6.30)	160 (6.30)	160 (6.30)
Reel Dimensions			
A max.	185 (7.28)	185 (7.28)	185 (7.28)
N min.	50 (1.97)	50 (1.97)	50 (1.97)
W ₁	$12.4 + 2.0/-0.0$ $(0.488 + 0.079/-0.0)$	$12.4 + 2.0/-0.0$ $(0.488 + 0.079/-0.0)$	$12.4 + 2.0/-0.0$ $(0.488 + 0.079/-0.0)$
W ₂ max.	18.4 (0.724)	18.4 (0.724)	18.4 (0.724)

11. Storage Conditions:

Temperature : 40°C max, Humidity : 40%~70%

12. Shelf Life:

2 years from manufacturing date