



# TIP122FP TIP127FP

## COMPLEMENTARY SILICON POWER DARLINGTON TRANSISTORS

- STMicroelectronics PREFERRED SALESTYPES
- FULLY MOLDED ISOLATED PACKAGE
- 2000 V DC ISOLATION (U.L. COMPLIANT)

### DESCRIPTION

The TIP122FP is a silicon Epitaxial-Base NPN power transistor in monolithic Darlington configuration mounted in Jedec TO-220FP fully molded isolated package. It is intended for use in power linear and switching applications.

The complementary PNP type is TIP127FP.

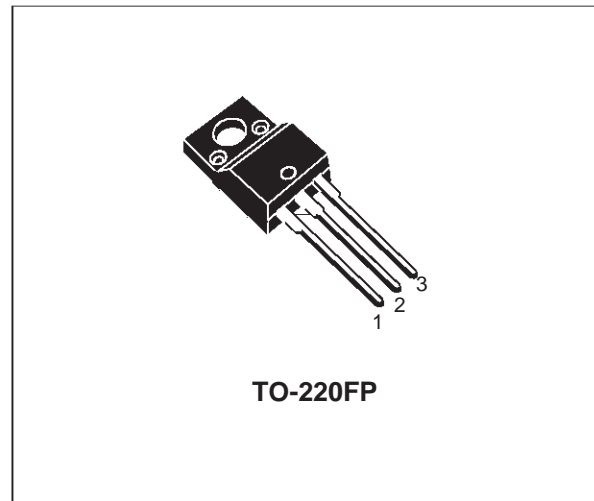

### INTERNAL SCHEMATIC DIAGRAM

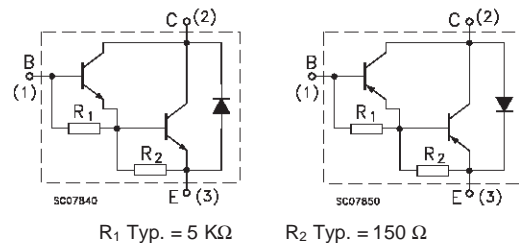

### ABSOLUTE MAXIMUM RATINGS

Symbol	Parameter	Value		Unit
		NPN	TIP122FP	
		PNP	TIP127FP	
$V_{CBO}$	Collector-Base Voltage ( $I_E = 0$ )		100	V
$V_{CEO}$	Collector-Emitter Voltage ( $I_B = 0$ )		100	V
$V_{EBO}$	Emitter-Base Voltage ( $I_C = 0$ )		5	V
$I_C$	Collector Current		5	A
$I_{CM}$	Collector Peak Current		8	A
$I_B$	Base Current		0.1	A
$P_{tot}$	Total Dissipation at $T_{case} \leq 25^\circ C$ $T_{amb} \leq 25^\circ C$		29	W
			2	W
$T_{stg}$	Storage Temperature		-65 to 150	$^\circ C$
$T_j$	Max. Operating Junction Temperature		150	$^\circ C$

For PNP types voltage and current values are negative.

# TIP122FP / TIP127FP

## THERMAL DATA

R <sub>thj-case</sub>	Thermal Resistance Junction-case	Max	4.3	°C/W
R <sub>thj-amb</sub>	Thermal Resistance Junction-ambient	Max	62.5	°C/W

## ELECTRICAL CHARACTERISTICS (T<sub>case</sub> = 25 °C unless otherwise specified)

Symbol	Parameter	Test Conditions	Min.	Typ.	Max.	Unit
I <sub>CEO</sub>	Collector Cut-off Current (I <sub>B</sub> = 0)	V <sub>CE</sub> = 50 V			0.5	mA
I <sub>CBO</sub>	Collector Cut-off Current (I <sub>B</sub> = 0)	V <sub>CB</sub> = 100 V			0.2	mA
I <sub>EBO</sub>	Emitter Cut-off Current (I <sub>C</sub> = 0)	V <sub>EB</sub> = 5 V			2	mA
V <sub>CEO(sus)</sub> *	Collector-Emitter Sustaining Voltage (I <sub>B</sub> = 0)	I <sub>C</sub> = 30 mA	100			V
V <sub>CE(sat)</sub> *	Collector-Emitter Saturation Voltage	I <sub>C</sub> = 3 A I <sub>C</sub> = 5 A			2 4	V V
V <sub>BE(on)</sub> *	Base-Emitter Voltage	I <sub>C</sub> = 3 A V <sub>CE</sub> = 3 V			2.5	V
h <sub>FE</sub> *	DC Current Gain	I <sub>C</sub> = 0.5 A I <sub>C</sub> = 3 A	1000 1000			

\* Pulsed: Pulse duration = 300 μs, duty cycle 1.5 %.  
For PNP types voltage and current values are negative.

### Safe Operating Area

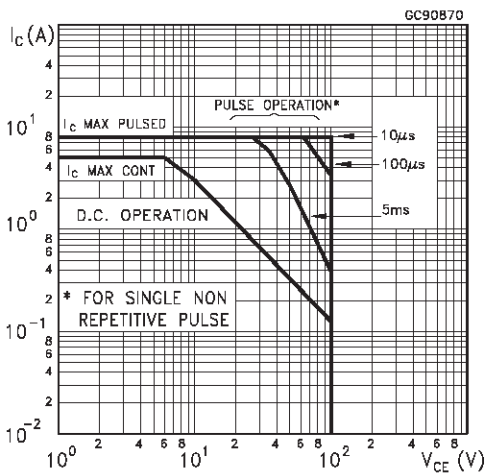

### Derating Curve

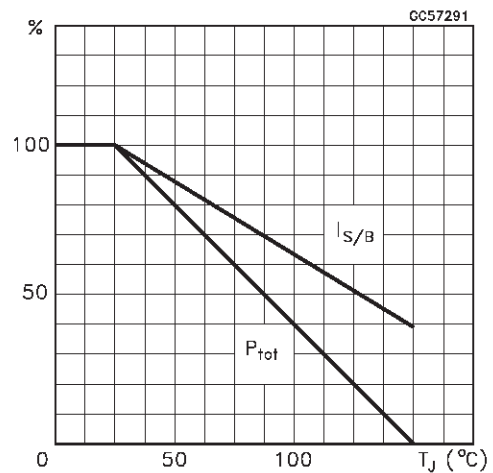

DC Current Gain (NPN type)

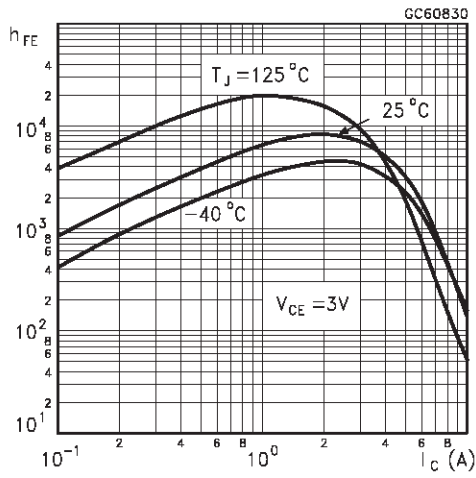

DC Current Gain (PNP type)

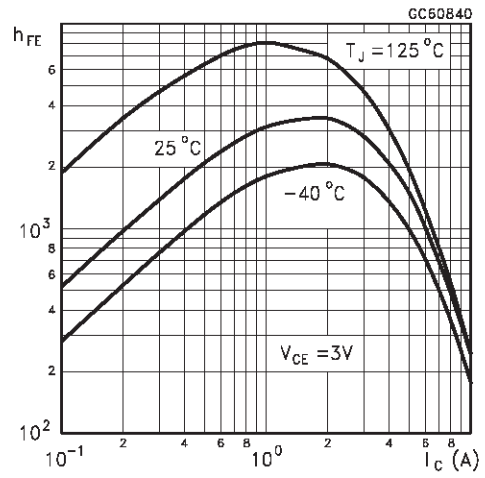

Collector Emitter Saturation Voltage (NPN type)

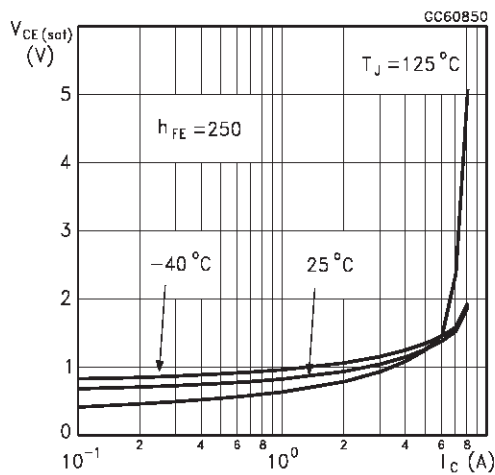

Collector Emitter Saturation Voltage (PNP type)

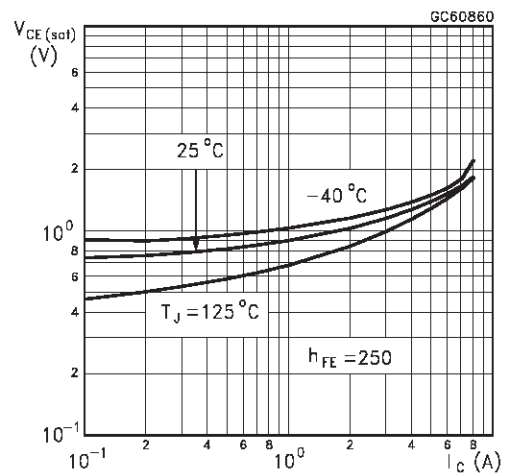

Base Emitter Saturation Voltage (NPN type)

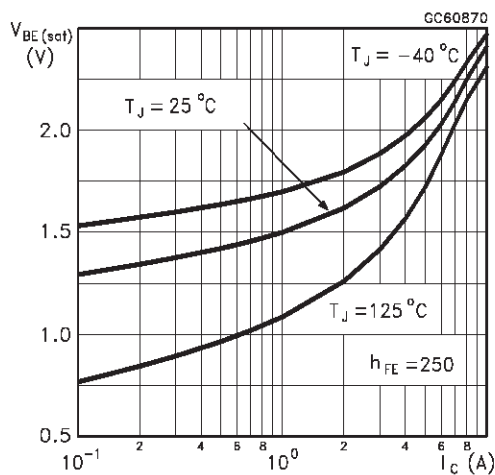

Base Emitter Saturation Voltage (PNP type)

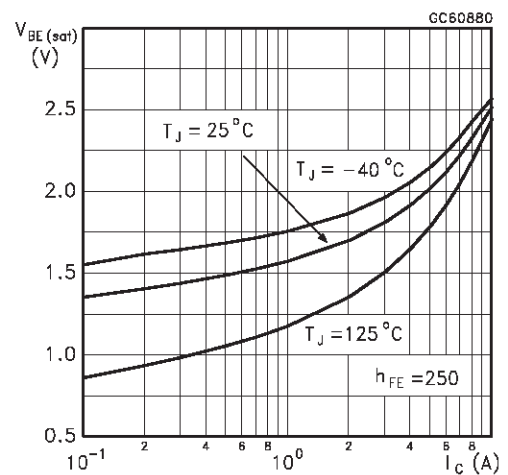

Base Emitter On Voltage (NPN type)

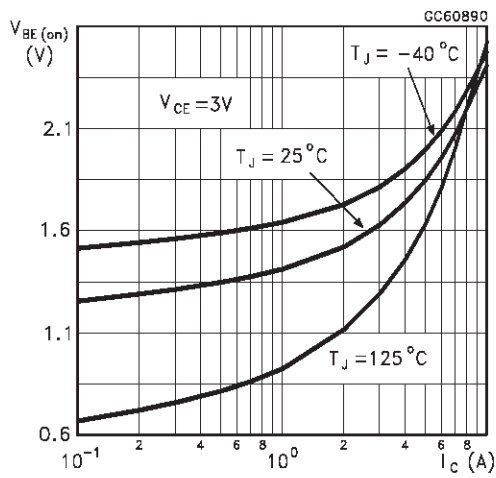

Base Emitter On Voltage (PNP type)

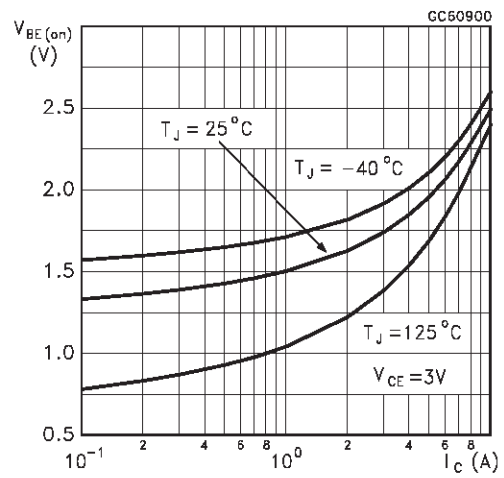

Freewheel Diode Forward Voltage (NPN type)

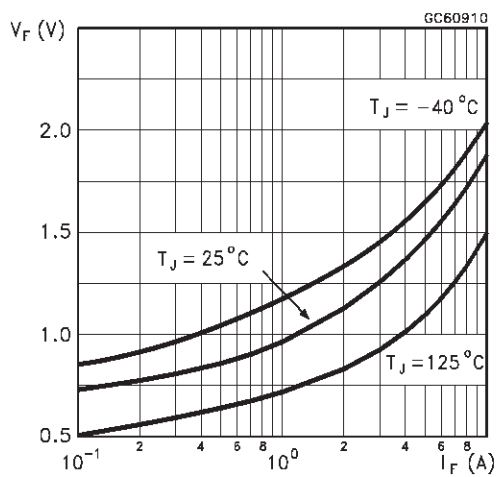

Freewheel Diode Forward Voltage (PNP type)

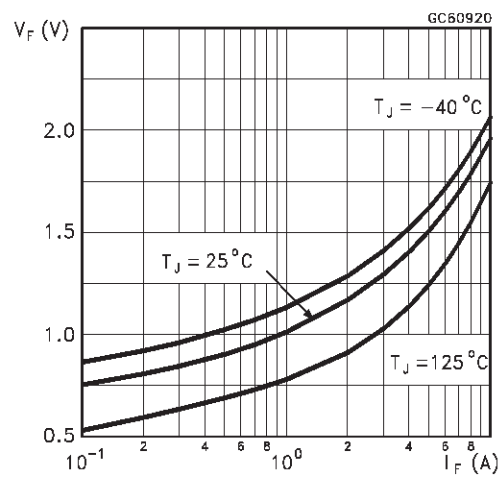

Switching Time Resistive Load (NPN type)

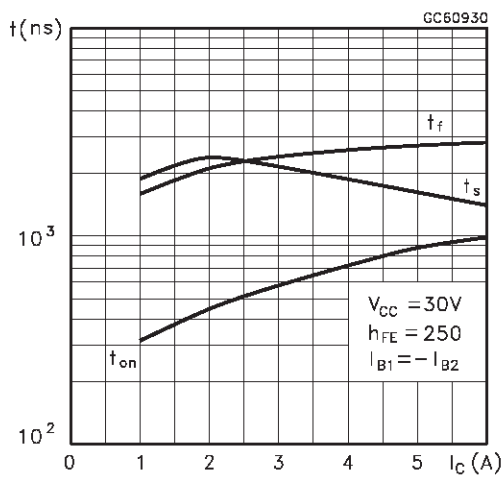

Switching Time resistive Load (PNP type)

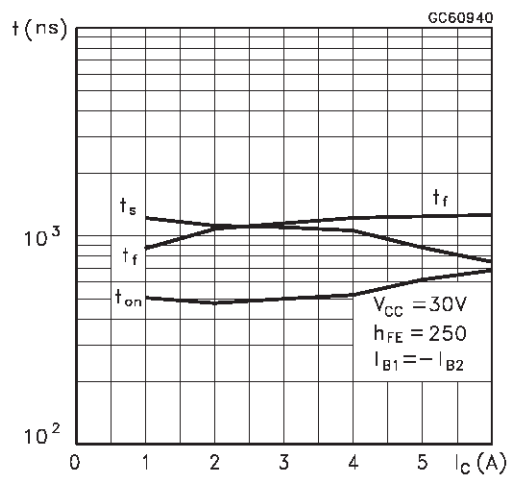

## TO-220FP MECHANICAL DATA

DIM.	mm			inch		
	MIN.	TYP.	MAX.	MIN.	TYP.	MAX.
A	4.4		4.6	0.173		0.181
B	2.5		2.7	0.098		0.106
D	2.5		2.75	0.098		0.108
E	0.45		0.7	0.017		0.027
F	0.75		1	0.030		0.039
F1	1.15		1.7	0.045		0.067
F2	1.15		1.7	0.045		0.067
G	4.95		5.2	0.195		0.204
G1	2.4		2.7	0.094		0.106
H	10		10.4	0.393		0.409
L2		16			0.630	
L3	28.6		30.6	1.126		1.204
L4	9.8		10.6	0.385		0.417
L6	15.9		16.4	0.626		0.645
L7	9		9.3	0.354		0.366
Ø	3		3.2	0.118		0.126

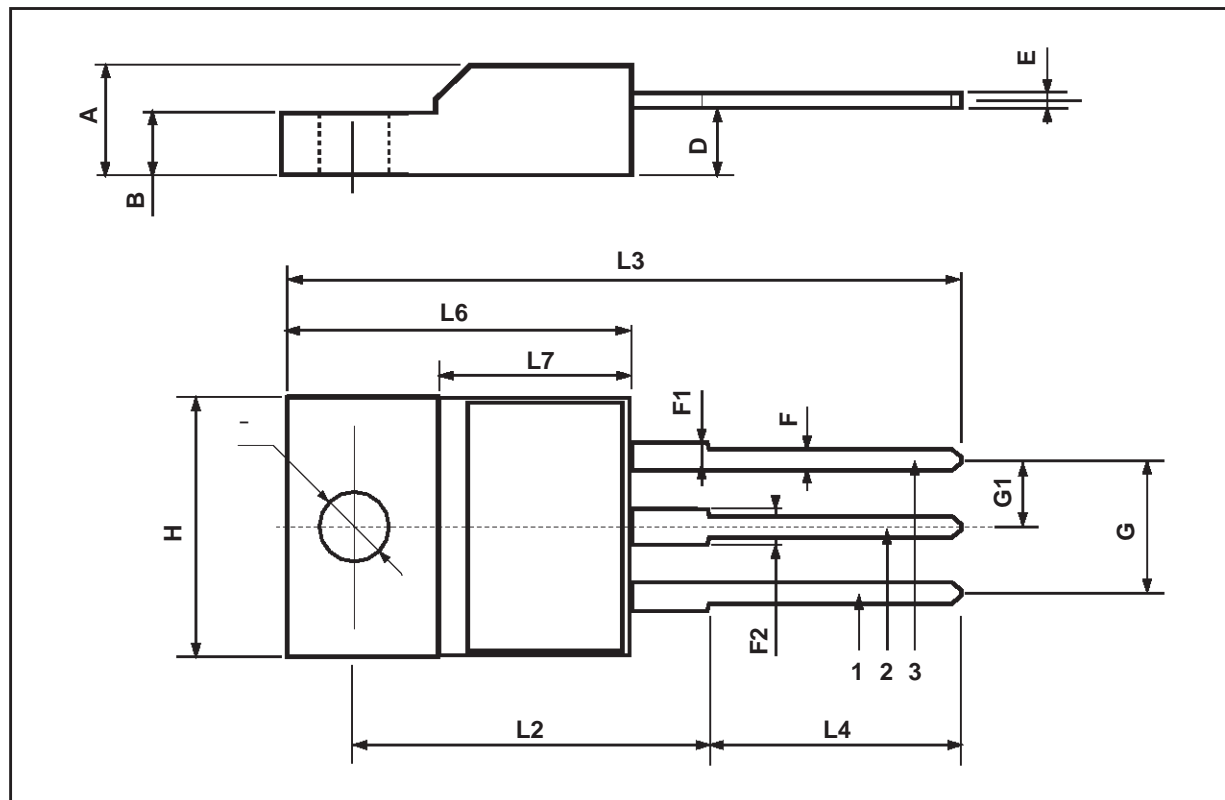

Information furnished is believed to be accurate and reliable. However, STMicroelectronics assumes no responsibility for the consequences of use of such information nor for any infringement of patents or other rights of third parties which may result from its use. No license is granted by implication or otherwise under any patent or patent rights of STMicroelectronics. Specification mentioned in this publication are subject to change without notice. This publication supersedes and replaces all information previously supplied. STMicroelectronics products are not authorized for use as critical components in life support devices or systems without express written approval of STMicroelectronics.

The ST logo is a trademark of STMicroelectronics

© 2000 STMicroelectronics – Printed in Italy – All Rights Reserved

STMicroelectronics GROUP OF COMPANIES

Australia - Brazil - China - Finland - France - Germany - Hong Kong - India - Italy - Japan - Malaysia - Malta - Morocco - Singapore - Spain - Sweden - Switzerland - United Kingdom - U.S.A.

<http://www.st.com>