



SGM3110

Micro-Power Regulated Charge Pump

GENERAL DESCRIPTION

The SGM3110 is a Micro-Power switched capacitor voltage converter that delivers a regulated output. No external inductor is required for operation.

The SGM3110 can deliver up to 100mA to the voltage regulated output. It features very low quiescent current and high efficiency over a large portion of its load range, making this device ideal for battery-powered applications. Furthermore, the combination of few external components and small package size keeps the total converter board area to a minimum in space-restricted applications.

The SGM3110 uses a pulse skipping technique to provide a regulated output from a varying input supply. The SGM3110 contains a thermal management circuit to protect the device under continuous output short-circuit conditions.

The SGM3110 is available in Green SOT-23-6 package and is rated over the -40°C to $+85^{\circ}\text{C}$ temperature range.

FEATURES

- Step-Up Voltage Converter
- Input Voltage Range:
 - SGM3110-5.0: 2.7V to 5.0V
 - SGM3110-4.5: 2.7V to 4.5V
- Micro-Power Consumption: 60 μA
- Fixed 5V, 4.5V \pm 4% Output
- Peak Current 250mA for 100ms
- High Frequency 750kHz Operation
- Logic-Controlled Shutdown
- Short-Circuit/Over-Temperature Protection
- Available in Green SOT-23-6 Package

APPLICATIONS

Cellular Phones
Digital Cameras
Handheld Electronics
LED/Display Backlight Driver
LEDs for Camera Flash
Portable Communication Devices
MP3 Players
GPS Receivers
PDAs

TYPICAL APPLICATION

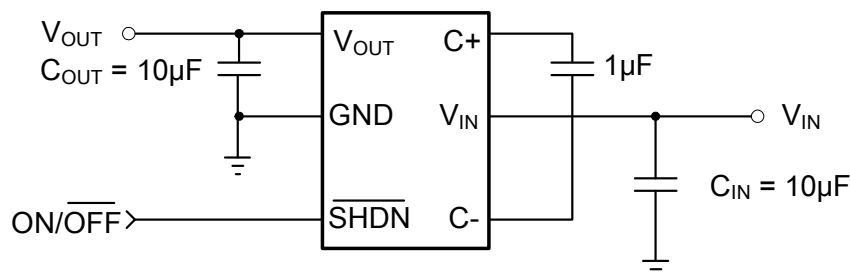

PACKAGE/ORDERING INFORMATION

ORDER NUMBER	PACKAGE DESCRIPTION	PACKAGE OPTION	MARKING INFORMATION
SGM3110-5.0YN6/TR	SOT-23-6	Tape and Reel, 3000	3110
SGM3110-4.5YN6/TR	SOT-23-6	Tape and Reel, 3000	3110A

ABSOLUTE MAXIMUM RATINGS

V _{IN} to GND	-0.3V to 6V
V _{OUT} to GND	-0.3V to 6V
SHDN to GND.....	-0.3V to 6V
Storage Temperature Range.....	-65°C to +150°C
Junction Temperature.....	160°C
Operating Temperature Range	-40°C to +85°C
Power Dissipation, P _D @ T _A = 25°C	
SOT-23-6	0.34W
Package Thermal Resistance	
SOT-23-6, θ _{JA}	250°C/W
Lead Temperature (Soldering 10 sec)	
.....	260°C
ESD Susceptibility	
HBM.....	2000V
MM.....	400V

NOTE:

Stresses beyond those listed under “Absolute Maximum Ratings” may cause permanent damage to the device. These are stress ratings only, and functional operation of the device at these or any other conditions beyond those indicated in the operational sections of the specifications is not implied. Exposure to absolute maximum rating conditions for extended periods may affect device reliability.

CAUTION

This integrated circuit can be damaged by ESD if you don't pay attention to ESD protection. SGMICRO recommends that all integrated circuits be handled with appropriate precautions. Failure to observe proper handling and installation procedures can cause damage. ESD damage can range from subtle performance degradation to complete device failure. Precision integrated circuits may be more susceptible to damage because very small parametric changes could cause the device not to meet its published specifications.

SGMICRO reserves the right to make any change in circuit design, specification or other related things if necessary without notice at any time. Please contact SGMICRO sales office to get the last datasheet.

PIN CONFIGURATION (TOP VIEW)

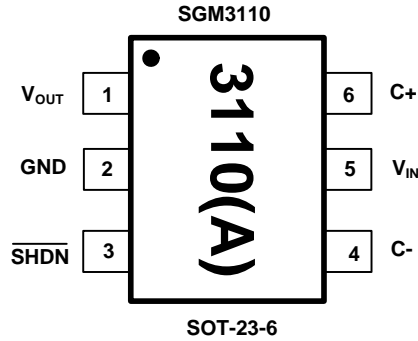

PIN DESCRIPTION

NAME	FUNCTION
V_{OUT}	Regulated output pin.
GND	Ground
\overline{SHDN}	Shutdown input. Logic low signal disables the converter.
C-	Flying capacitor negative terminal.
V_{IN}	Input supply pin.
C+	Flying capacitor positive terminal.

ELECTRICAL CHARACTERISTICS(T_A = -40°C to +85°C, unless otherwise noted. Typical values are at T_A = 25°C, C_{FLY} = 1μF, C_{IN} = 10μF, C_{OUT} = 10μF).

PARAMETER	SYMBOL	CONDITIONS	MIN	TYP	MAX	UNITS
SGM3110-5.0						
Input Voltage Range	V _{IN}	V _{OUT} = 5.0V	2.7		V _{OUT}	V
Output Voltage	V _{OUT}	2.7V < V _{IN} < 5V, I _{OUT} ≤ 50mA	4.8	5.0	5.2	V
		3.0V < V _{IN} < 5V, I _{OUT} ≤ 100mA	4.8	5.0	5.2	
Quiescent Power Supply Current	I _Q	2.7V < V _{IN} < 5V, I _{OUT} = 0mA, $\overline{\text{SHDN}} = V_{\text{IN}}$		60	68	μA
Shutdown Supply Current	I _{SHDN}	2.7V < V _{IN} < 3.6V, I _{OUT} = 0mA, V _{SHDN} = 0		0.2	1	μA
		3.6V < V _{IN} < 5V, I _{OUT} = 0mA, V _{SHDN} = 0			1	
Ripple Voltage	V _{RIPPLE}	V _{IN} = 2.7V, I _{OUT} = 50mA		15		mV _{P-P}
		V _{IN} = 3V, I _{OUT} = 100mA		88		
Efficiency	η	V _{IN} = 2.7V, I _{OUT} = 50mA		91		%
Frequency	f _{OSC}	Oscillator Free Running		750		kHz
$\overline{\text{SHDN}}$ Input Threshold High	V _{IH}		1.4			V
$\overline{\text{SHDN}}$ Input Threshold Low	V _{IL}				0.4	
$\overline{\text{SHDN}}$ Input High Current	I _{IH}	$\overline{\text{SHDN}} = V_{\text{IN}}$	-1		+1	μA
$\overline{\text{SHDN}}$ Input Low Current	I _{IL}	$\overline{\text{SHDN}} = \text{GND}$	-1		+1	μA
Turn-On Time	T _{ON}	V _{IN} = 3V, I _{OUT} = 0mA		0.3		ms
SGM3110-4.5						
Input Voltage Range	V _{IN}	V _{OUT} = 4.5V	2.7		V _{OUT}	V
Output Voltage	V _{OUT}	2.7V < V _{IN} < 4.5V, I _{OUT} ≤ 50mA	4.32	4.5	4.68	V
		3.0V < V _{IN} < 4.5V, I _{OUT} ≤ 100mA	4.32	4.5	4.68	
Quiescent Power Supply Current	I _Q	2.7V < V _{IN} < 4.5V, I _{OUT} = 0mA, $\overline{\text{SHDN}} = V_{\text{IN}}$		60	68	μA
Shutdown Supply Current	I _{SHDN}	2.7V < V _{IN} < 3.6V, I _{OUT} = 0mA, V _{SHDN} = 0		0.2	1	μA
		3.6V < V _{IN} < 4.5V, I _{OUT} = 0mA, V _{SHDN} = 0			1	
Ripple Voltage	V _{RIPPLE}	V _{IN} = 2.7V, I _{OUT} = 50mA		15		mV _{P-P}
		V _{IN} = 3V, I _{OUT} = 100mA		88		
Efficiency	η	V _{IN} = 2.7V, I _{OUT} = 50mA		83		%
Frequency	f _{OSC}	Oscillator Free Running		750		kHz
$\overline{\text{SHDN}}$ Input Threshold High	V _{IH}		1.4			V
$\overline{\text{SHDN}}$ Input Threshold Low	V _{IL}				0.4	
$\overline{\text{SHDN}}$ Input High Current	I _{IH}	$\overline{\text{SHDN}} = V_{\text{IN}}$	-1		+1	μA
$\overline{\text{SHDN}}$ Input Low Current	I _{IL}	$\overline{\text{SHDN}} = \text{GND}$	-1		+1	μA
Turn-On Time	T _{ON}	V _{IN} = 3V, I _{OUT} = 0mA		0.3		ms

TYPICAL PERFORMANCE CHARACTERISTICS

At $V_S = +5.0V$, $T_A = +25^\circ C$, $V_{IN} = 3V$, $C_{IN} = C_{OUT} = 10\mu F$, $C_{FLY} = 1\mu F$, unless otherwise noted.

Startup Time with 50mA Load

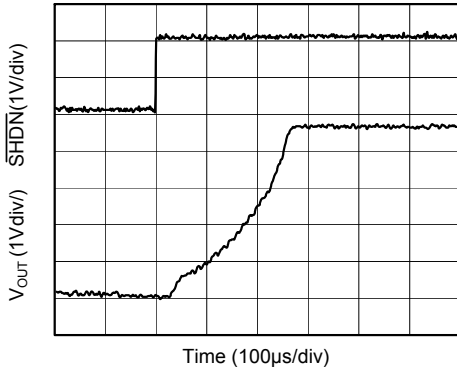

Startup Time with 100mA Load

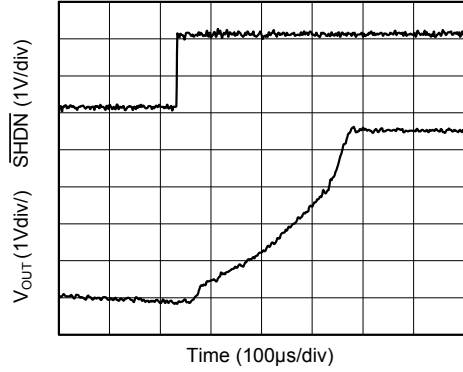

Output Ripple with I_{OUT} = 50mA

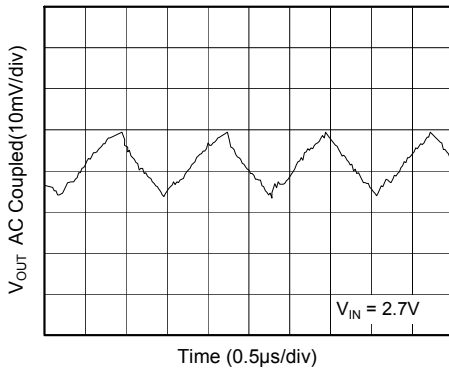

Output Ripple with I_{OUT} = 100mA

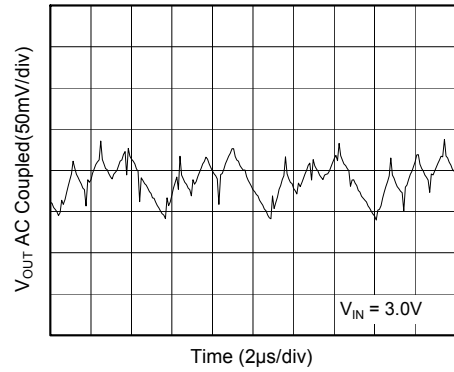

Load Transient Response for 50mA

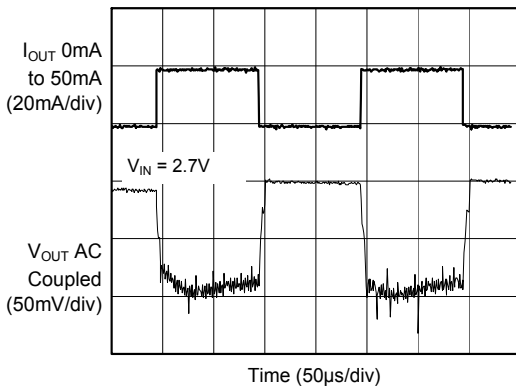

Load Transient Response for 100mA

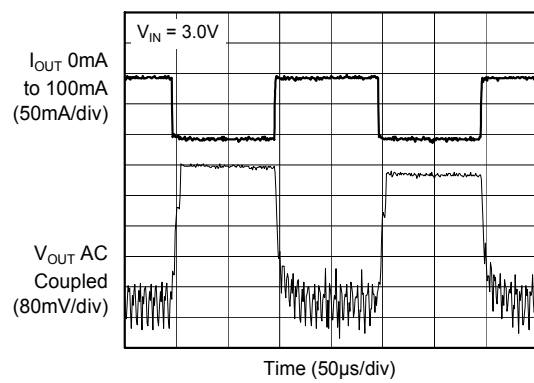

TYPICAL PERFORMANCE CHARACTERISTICS

At $V_S = +5.0V$, $T_A = +25^\circ C$, $V_{IN} = 3V$, $C_{IN} = C_{OUT} = 10\mu F$, $C_{FLY} = 1\mu F$, unless otherwise noted.

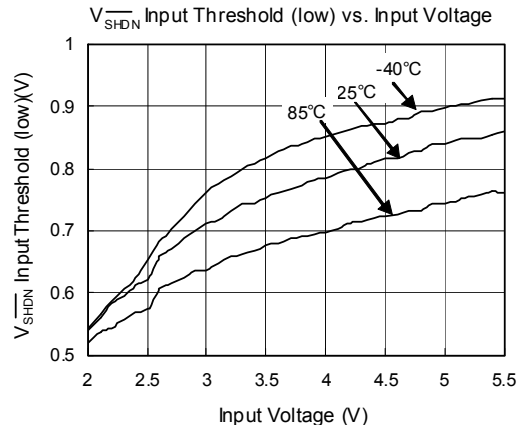
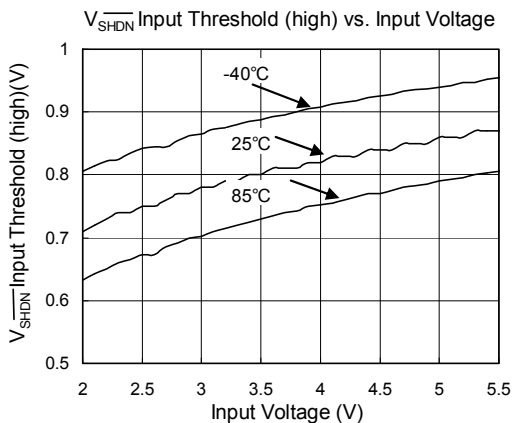
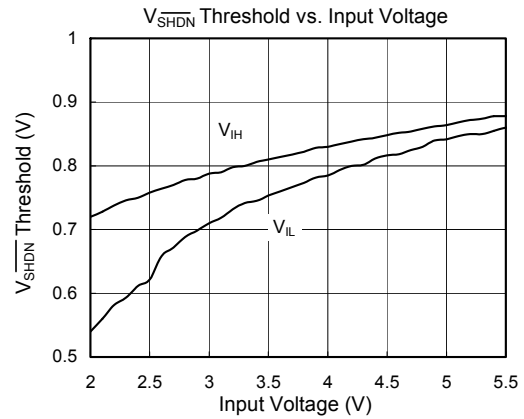
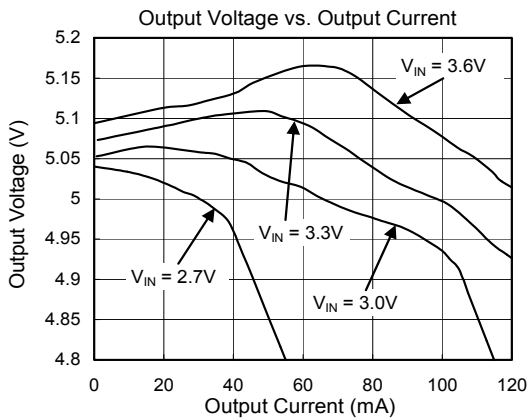
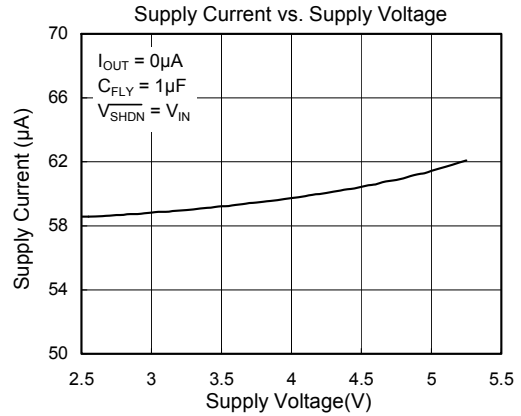
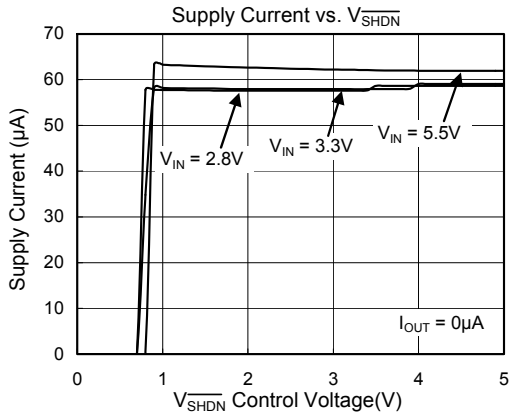

TYPICAL PERFORMANCE CHARACTERISTICS

At $V_S = +5.0V$, $T_A = +25^\circ C$, $V_{IN} = 3V$, $C_{IN} = C_{OUT} = 10\mu F$, $C_{FLY} = 1\mu F$, unless otherwise noted.

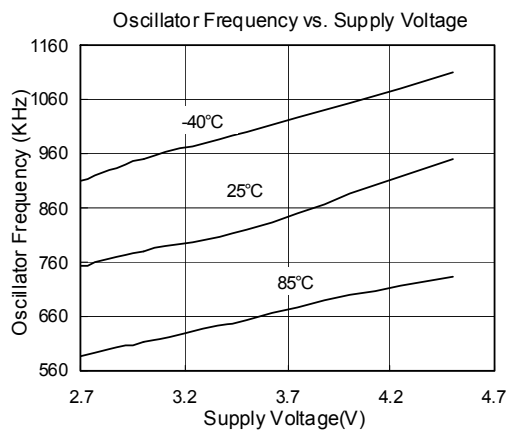
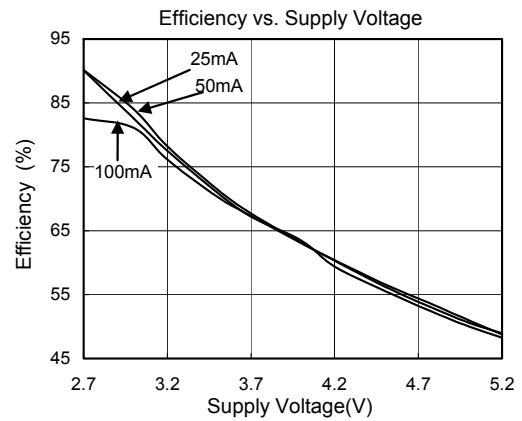
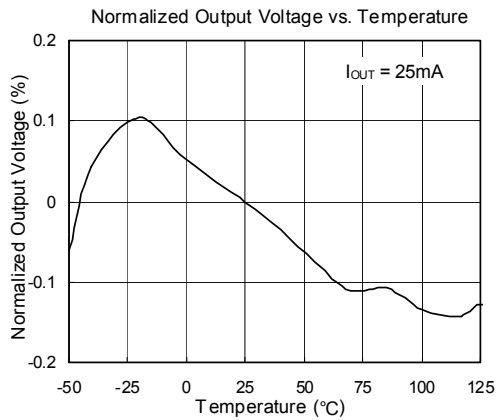

PACKAGE OUTLINE DIMENSIONS

SOT-23-6

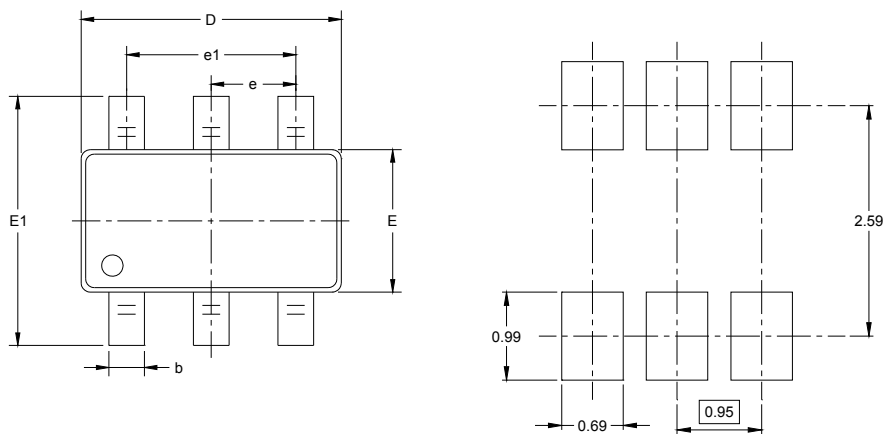

RECOMMENDED LAND PATTERN (Unit: mm)

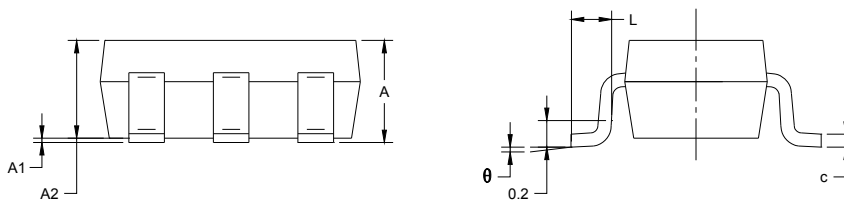

Symbol	Dimensions In Millimeters		Dimensions In Inches	
	MIN	MAX	MIN	MAX
A	1.050	1.250	0.041	0.049
A1	0.000	0.100	0.000	0.004
A2	1.050	1.150	0.041	0.045
b	0.300	0.500	0.012	0.020
c	0.100	0.200	0.004	0.008
D	2.820	3.020	0.111	0.119
E	1.500	1.700	0.059	0.067
E1	2.650	2.950	0.104	0.116
e	0.950 BSC		0.037 BSC	
e1	1.900 BSC		0.075 BSC	
L	0.300	0.600	0.012	0.024
θ	0°	8°	0°	8°

TAPE AND REEL INFORMATION

REEL DIMENSIONS

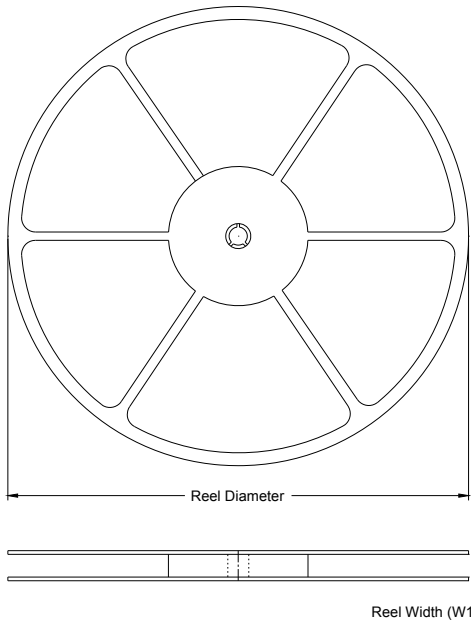

TAPE DIMENSIONS

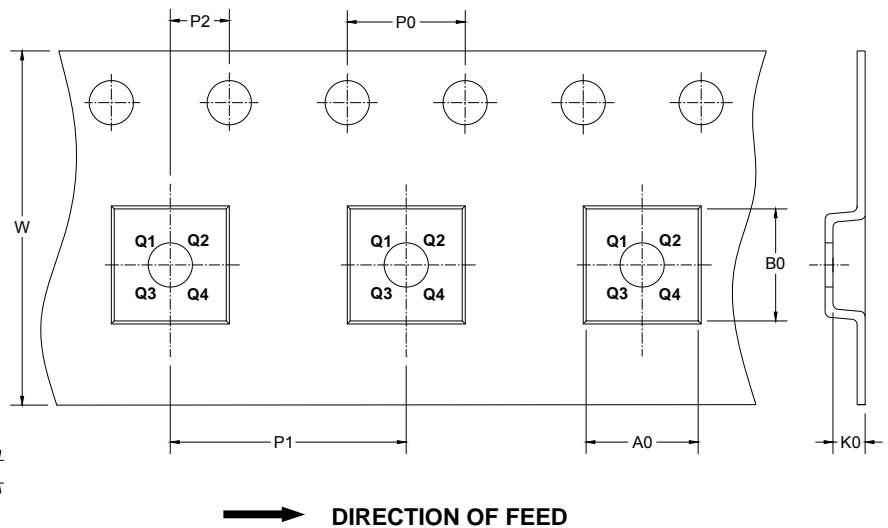

NOTE: The picture is only for reference. Please make the object as the standard.

KEY PARAMETER LIST OF TAPE AND REEL

Package Type	Reel Diameter	Reel Width W1 (mm)	A0 (mm)	B0 (mm)	K0 (mm)	P0 (mm)	P1 (mm)	P2 (mm)	W (mm)	Pin1 Quadrant
SOT-23-6	7"	9.5	3.17	3.23	1.37	4.0	4.0	2.0	8.0	Q3

CARTON BOX DIMENSIONS

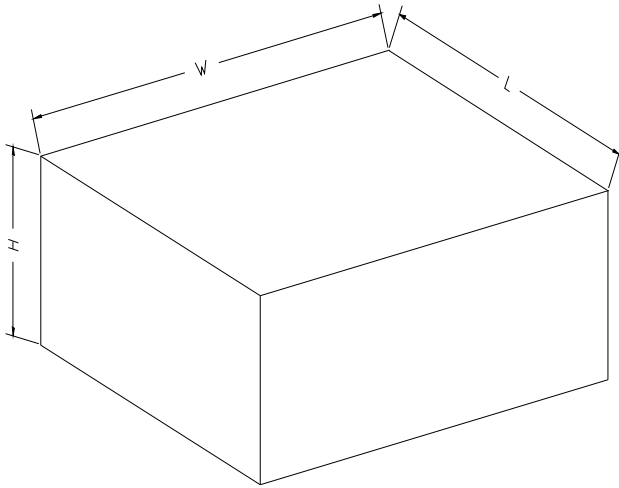

NOTE: The picture is only for reference. Please make the object as the standard.

KEY PARAMETER LIST OF CARTON BOX

Reel Type	Length (mm)	Width (mm)	Height (mm)	Pizza/Carton
7" (Option)	368	227	224	8
7"	442	410	224	18