

DATE	SYM.	DESCRIPTION	DR	CK	REL

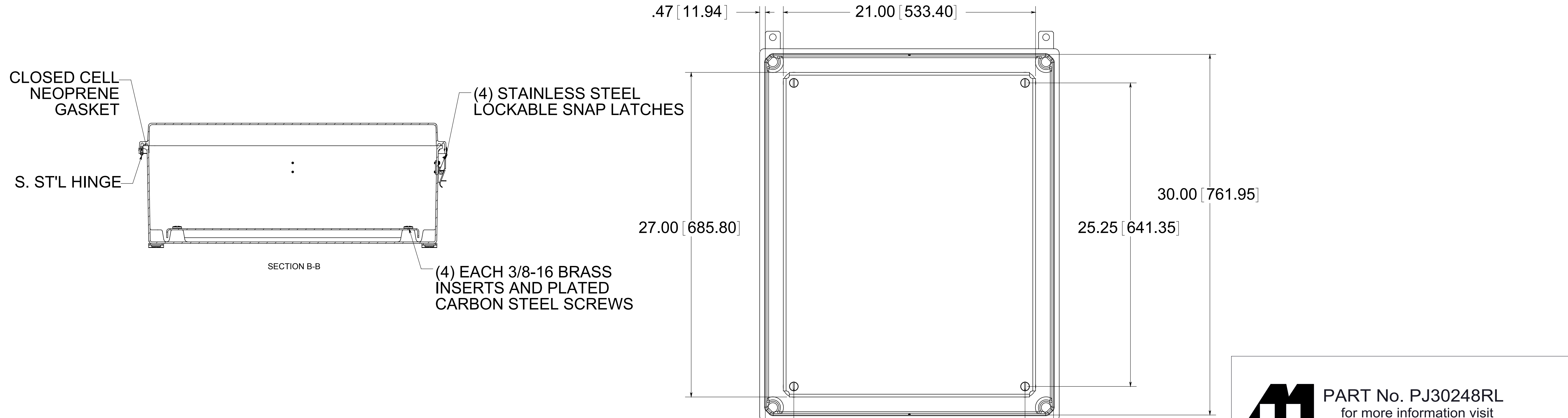
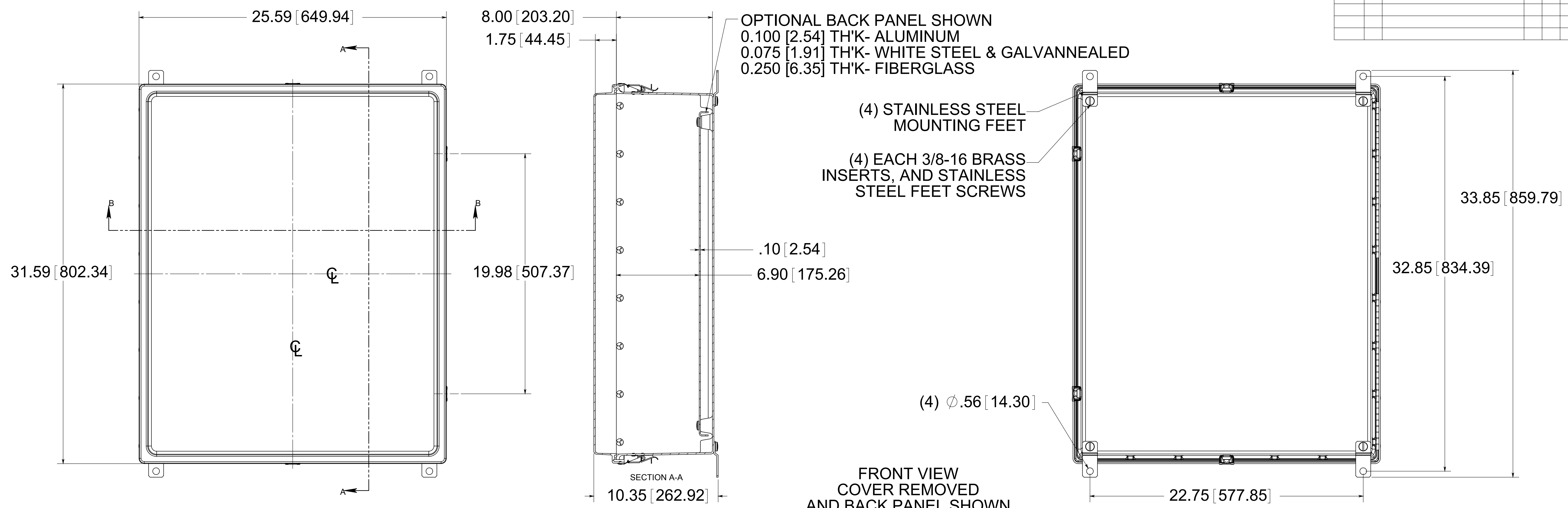

MATERIAL:
 BOX- COMPRESSION MOLDED FIBERGLASS REINFORCED POLYESTER
 COVER- COMPRESSION MOLDED FIBERGLASS REINFORCED POLYESTER
 WINDOW- POLYCARBONATE

PART No. PJ30248RL
 for more information visit
www.hammfg.com
 Data subject to change without notice
 Drawing Not to Scale