

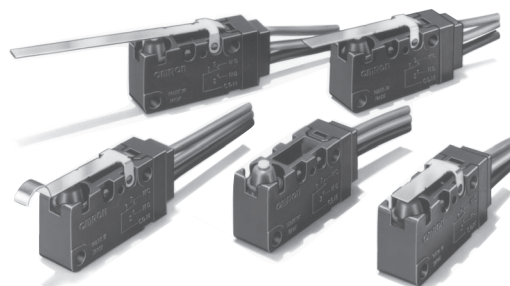







Sealed Snap Action Switch D2VW

Watertight Miniature Snap Action Switch

- High-quality watertight, high-precision miniature Snap Action switch. Switch Body meets IP67 requirements
- Use of epoxy resin assures high sealing capability and is ideal for dusty places or where water is sprayed
- V-series internal mechanism assures high precision and long life
- General-load (5 A at 250 VAC) models and micro-load models are available
- RoHS Compliant



Ordering Information

Actuator	Terminal	Model	
		Model 0.1 A	Model 5 A
Pin plunger 	With solder and #187 tab terminals	D2VW-01-1HS	D2VW-5-1HS
	With lead wires	D2VW-01-1MS	D2VW-5-1MS
Short hinge lever 	With solder and #187 tab terminals	D2VW-01L1A-1HS	D2VW-5L1A-1HS
	With lead wires	D2VW-01L1A-1MS	D2VW-5L1A-1MS
Hinge lever 	With solder and #187 tab terminals	D2VW-01L1-1HS	D2VW-5L1-1HS
	With lead wires	D2VW-01L1-1MS	D2VW-5L1-1MS
Long hinge lever 	With solder and #187 tab terminals	D2VW-01L1B-1HS	D2VW-5L1B-1HS
	With lead wires	D2VW-01L1B-1MS	D2VW-5L1B-1MS
Simulated roller lever 	With solder and #187 tab terminals	D2VW-01L3-1HS	D2VW-5L3-1HS
	With lead wires	D2VW-01L3-1MS	D2VW-5L3-1MS
Short hinge roller lever 	With solder and #187 tab terminals	D2VW-01L2A-1HS	D2VW-5L2A-1HS
	With lead wires	D2VW-01L2A-1MS	D2VW-5L2A-1MS
Hinge roller lever 	With solder and #187 tab terminals	D2VW-01L2-1HS	D2VW-5L2-1HS
	With lead wires	D2VW-01L2-1MS	D2VW-5L2-1MS

- Note:**
1. The standard lengths of the lead wires (UL1015 AWG20 for UL/CSA models, AV0.75f otherwise) of models incorporating them are 30 cm.
 2. Remove “-HS” from the end of solder/quick-connect models to obtain non-UL/CSA versions. (e.g.: D2VW-01-1HS → D2VW-01-1)
 3. Remove “S” from the end of lead wire models to obtain non-UL/CSA versions with AV0.75f wire. (e.g.: D2VW-5L3-1MS → D2VW-5L3-1M)

Model Number Legend

D2VW-□ □ - □ □
1 2 3 4

- | | | | |
|--|--|---|---|
| 1. Ratings | 2. Actuator | 3. Contact Form | 4. Terminals |
| 5: 5 A at 250 VAC
01: 0.1 A at 30 VDC | None: Pin plunger
L1A: Short hinge lever
L1: Hinge lever
L1B: Long hinge lever
L3: Simulated roller lever
L2A: Short hinge roller lever
L2: Hinge roller lever | 1: SPDT
2: SPST-NC*
3: SPST-NO*

*Lead wire versions only | None, HS: Solder terminals
(HS for UL and CSA approval.)
M, MS: Molded lead wires
(MS for UL and CSA approval) |

Specifications

■ Characteristics

Model	D2VW-01	D2VW-5
Operating speed	0.1 mm to 1 m/s (at pin plunger)	
Operating frequency	Mechanical: 300 operations/minute max. Electrical: 30 operations/minute max.	
Insulation resistance	100 MΩ min. (at 500 VDC)	
Contact resistance	50 mΩ max. (100 mΩ max. for molded lead wire models)	
Dielectric strength (See note 2)	1,000 VAC, 50/60 Hz for 1 min. between terminals of the same polarity 1,500 VAC, 50/60 Hz for 1 min. between each current-carrying metal parts and ground, and between each terminal and non-current-carrying metal parts.	
Vibration resistance (See note 3)	Malfunction: 10 to 55 Hz, 1.5 mm double amplitude	
Shock resistance (See note 3)	Destruction: 1,000 m/s ² (approx. 100G) max. Malfunction: 300 m/s ² (approx. 30G) max.	
Degree of protection	IEC IP67 (excluding the terminals on terminal models).	
Degree of protection against electric shock	Class I	
Proof tracking index (PTI)	175	
Ambient operating temperature	-40° to 85°C (at 60% RH max.) with no icing	
Ambient operating humidity	95% max. (for 5°C to 35°C)	
Life expectancy	Mechanical	10,000,000 operations min. at 60 operations per minute
	Electrical	1,000,000 operations min. at 30 ops. per minute. 100,000 operations min. at 30 ops. per minute
Weight	Approx. 7g (pin plunger models without wires)	

Note: 1. Data shown are of initial value.

2. The dielectric strength shown is measured using a separator between the switch and metal mounting plate.

3. For the pin plunger models, the above values apply for use at the free position and total travel position. For the lever models, the values apply at the total travel position.

4. The operating temperature of the lead wire (AV0.75f) for non-UL/CSA molded lead wire models is between -40 to 85°C.

■ Ratings (reference values)

D2VW-5

Rated Voltage	Non-inductive load				Inductive load			
	Resistive load		Lamp load		Inductive load		Motor load	
	NC	NO	NC	NO	NC	NO	NC	NO
125 VAC	5 A		0.5 A		4 A		—	
250 VAC	5 A		0.5 A		4 A		—	
30 VDC	5 A		3 A		4 A		—	
125 VDC	0.4 A		0.1 A		0.4 A		—	

D2VW-01

Rated Voltage	Non-inductive load				Inductive load			
	Resistive load		Lamp load		Inductive load		Motor load	
	NC	NO	NC	NO	NC	NO	NC	NO
125 VAC	0.1 A		—		—		—	
30 VDC	0.1 A		—		—		—	

Note: 1. The resistive load ratings apply under the following test conditions:

Ambient Temperature = 20±2°C, Ambient Humidity = 65±5%, Operating frequency = 30 operations/min.

2. The above current ratings are the values of the steady-state current.

3. Inductive load has a power factor of 0.7 min. (AC) and a time constant of 7 ms max. (DC).

4. Lamp load has an inrush current of 10 times the steady-state current.

5. Rating for UL/CSA approval is as follows (See “Approved Standards” section):

D2VW-01 0.1A @ 125 VAC

0.1A @ 30 VDC

D2VW-5 3A @ 125 VAC, 250 VAC

■ Approved Standards

Consult your OMRON sales representative for specific models with standard approvals.

UL Recognized, CSA Certified

Rated Voltage	D2VW-5	D2VW-01
125 VAC	3 A	0.1 A
250 VAC	3 A	---
30 VDC	---	0.1 A

EN 61058-1 (VDE Approval)

Rated Voltage	D2VW-5	D2VW-01
125 VAC	---	0.1 A
250 VAC	3 A	---

Testing conditions:

25E3 (25,000 operations), T85 (0°C to 85°C) for D2VW-5
 1E5 (100,000 operations), T85 (0°C to 85°C) for D2VW-01

■ Contact Specifications

Item	D2VW-5	D2VW-01
Specification	Rivet	Crossbar
Material	Silver alloy	Gold alloy
Gap (standard value)	0.5 mm	
Inrush current	NC: 15 A max. NO: 15 A max.	---
Minimum applicable load (see note)	160 mA at 5 VDC	1 mA at 5 VDC

Note: Minimum applicable loads are indicated by N standard reference values. This value represents the failure rate at a 60% (λ_{60}) reliability level (JIS C5003).
 The equation $\lambda_{60} = 0.5 \times 10^{-6} / \text{operations}$ indicates that a failure rate of 1/2,000,000 operations can be expected at a reliability level of 60%

Engineering Data

■ Structure

SPDT

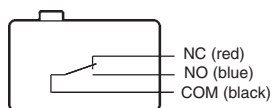

SPST-NC

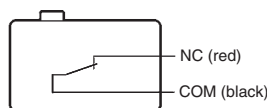

SPST-NO

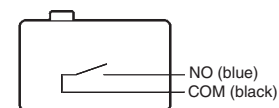

Note: Colors in parentheses indicate lead wire colors.

■ Mounting

All switches may be panel mounted using M3 mounting screws with plane washers or spring washers to securely mount the switch. Tighten the screws to a torque of 0.39 to 0.59 N·m.

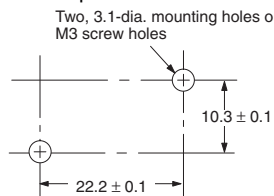

Dimensions

■ Terminals

- Note:** 1. Unless otherwise specified, all units are in millimeters and a tolerance of ± 0.4 mm applies to all dimensions
 2. The pin plunger model is shown here as a typical example for both the solder/quick connect terminals and the molded lead wire versions.

Solder/Quick Connect Terminals

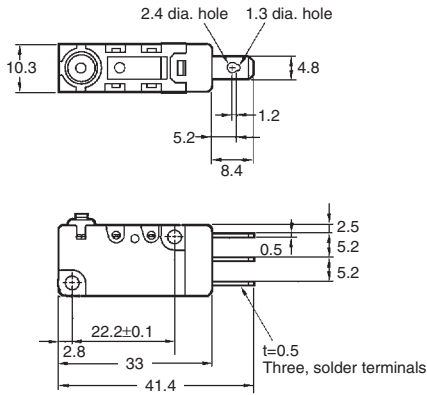

Molded Lead Wires

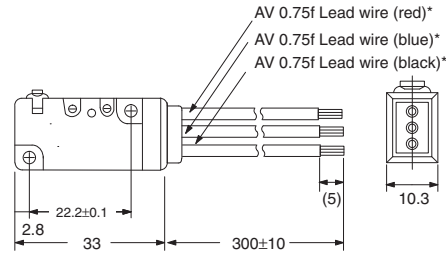

* UL/CSA approved models have AWG20 UL approved wiring.

■ Dimensions and Operating Characteristics

- Note:** 1. Unless otherwise specified, all units are in millimeters and a tolerance of ± 0.4 mm applies to all dimensions
 2. Omitted dimensions are the same as pin plunger type.
 3. The operating characteristics are for operation in the A direction(▼)

Pin Plunger Models

D2VW-01-1HS
 D2VW-5-1HS

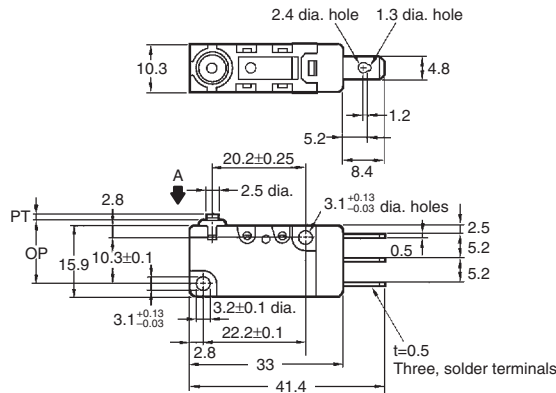
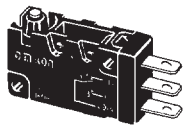

OF max	200 gf
RF min.	30 gf
PT max.	1.2 mm
OT min.	1.0 mm
MD max.	0.4 mm
OP	14.7 ± 0.4 mm

Short Hinge Lever Models

D2VW-01L1A-1MS
 D2VW-5L1A-1MS

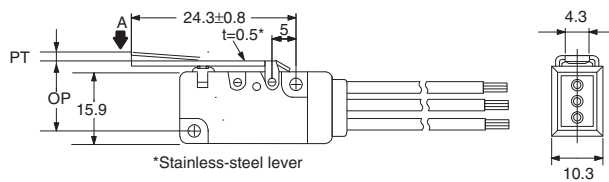
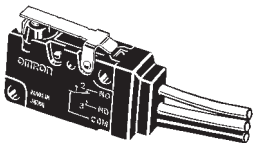

OF max	200 gf
RF min.	20 gf
PT max.	1.6 mm
OT min.	0.8 mm
MD max.	0.5 mm
OP	15.2 ± 0.5 mm

Hinge Lever Models

D2VW-01L1-1MS
 D2VW-5L1-1MS

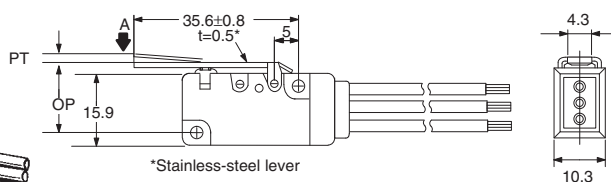
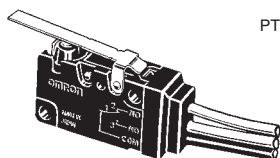

OF max	120 gf
RF min.	15 gf
PT max.	4.0 mm
OT min.	1.6 mm
MD max.	0.8 mm
OP	15.2 ± 1.2 mm

- Note:** 1. Unless otherwise specified, all units are in millimeters and a tolerance of ± 0.4 mm applies to all dimensions
 2. Omitted dimensions are the same as pin plunger type.
 3. The operating characteristics are for operation in the A direction(↓)

Long Hinge Lever Models

D2VW-01L1B-1MS
 D2VW-5L1B-1MS

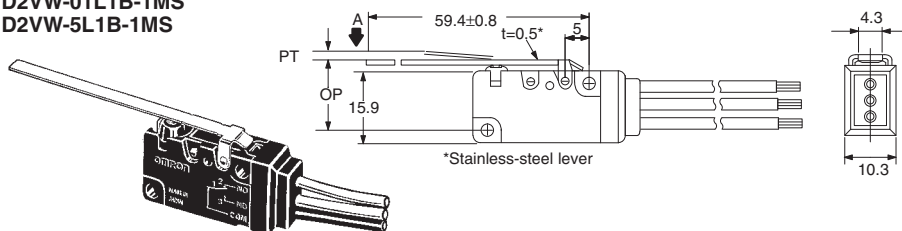

OF max	60 gf
RF min.	5 gf
PT max.	9.0 mm
OT min.	3.2 mm
MD max.	2.0 mm
OP	15.2 ± 2.6 mm

Simulated Roller Lever Models

D2VW-01L3-1MS
 D2VW-5L3-1MS

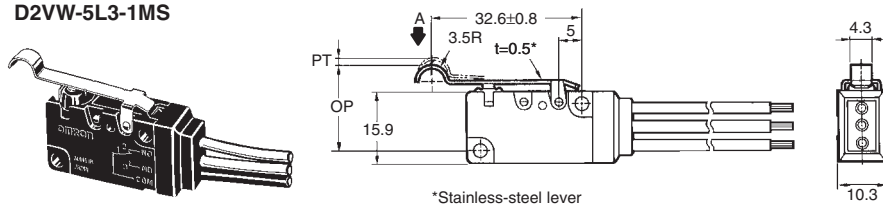

OF max	120 gf
RF min.	15 gf
PT max.	4.0 mm
OT min.	1.6 mm
MD max.	0.8 mm
OP	18.7 ± 1.2 mm

Short Hinge Roller Lever Models

D2VW-01L2A-1MS
 D2VW-5L2A-1MS

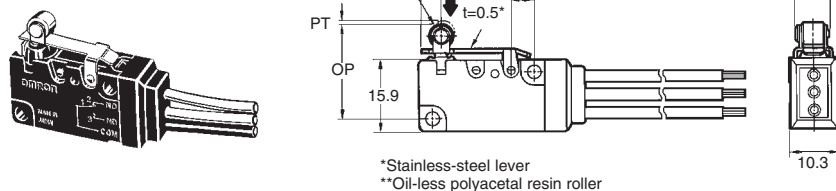

OF max	230 gf
RF min.	20 gf
PT max.	1.6 mm
OT min.	0.8 mm
MD max.	0.5 mm
OP	20.7 ± 0.6 mm

Hinge Roller Lever Models

D2VW-01L2-1MS
 D2VW-5L2-1MS

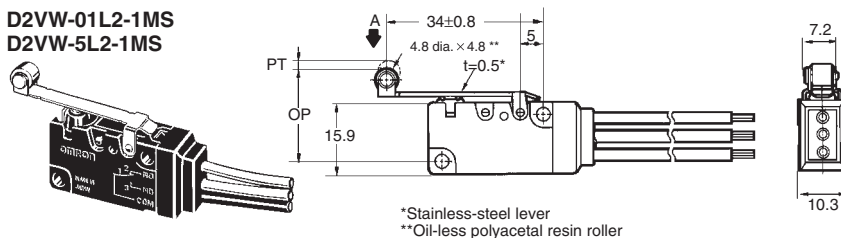

OF max	120 gf
RF min.	15 gf
PT max.	4.0 mm
OT min.	1.6 mm
MD max.	0.8 mm
OP	20.7 ± 1.2 mm

Precautions

Be sure to read the precautions and information common to all Snap Action and Detection Switches, contained in the Technical User's Guide, "Snap Action Switches, Technical Information" for correct use.

Correct Use

Operations

Make sure that the switching object is perfectly separated from the actuator when the switch is not operated and the actuator is pressed appropriately by the switching object when the switch is operated.

The switch should be set so that its stroke will be within the rated OT when the switch is operated.

With the pin plunger models, set the switch so that the plunger can be actuated from directly above. Since the plunger is covered with a rubber cap, applying a force from lateral directions may cause damage to the plunger or reduction in the sealing capability.

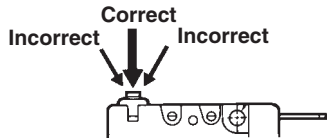

Handling

Handle the switch carefully so as not to break the sealing rubber of the plunger.

Using Microloads

Using a model for ordinary loads to switch microloads may result in faulty operation. Instead, use the models that are designed for microloads and that operate in the following range;

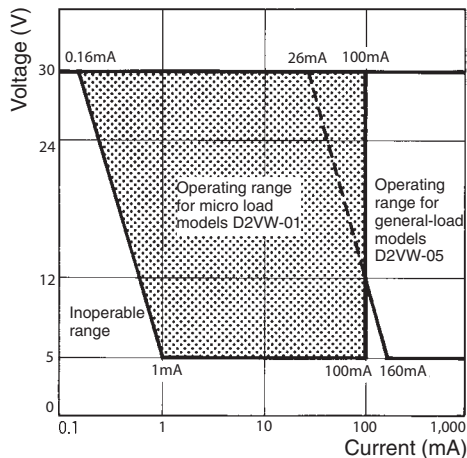

However, even when using microload models within the operating range shown above, if inrush current or inductive voltage spikes occur when the contact is opened or closed, then contact wear may increase and so decrease the service life. Therefore, insert a contact protection circuit where necessary.

Cautions

Degree of Protection

The D2VW was tested under water and passed the following watertightness test, which however, does not mean that the D2VW can be used in the water.

JIS C0929 (rules for testing the watertightness of electrical devices and materials), class 7 (watertightness test). Refer to the following illustration for the test method at OMRON.

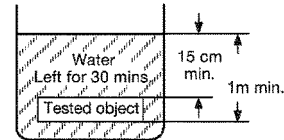

Note: The object to be tested is left in the water for 30 minutes on condition that the distance between the surface of the water and the top of the object be 15 cm minimum and the distance between the surface of the water and the bottom of the object be 1 m minimum.

Protection Against Chemicals

Prevent the switch from coming into contact with oil and chemicals. Otherwise, damage to or deterioration of the switch materials may occur.

A large grid of 20 columns and 30 rows of small squares, intended for taking notes. The grid is composed of thin, light gray lines forming a uniform pattern of squares across the page.

All sales are subject to Omron Electronic Components LLC standard terms and conditions of sale, which can be found at http://www.components.omron.com/components/web/webfiles.nsf/sales_terms.html

ALL DIMENSIONS SHOWN ARE IN MILLIMETERS.
To convert millimeters into inches, multiply by 0.03937. To convert grams into ounces, multiply by 0.03527.

OMRON[®]

**OMRON ELECTRONIC
COMPONENTS LLC**

55 E. Commerce Drive, Suite B
Schaumburg, IL 60173

847-882-2288

OMRON ON-LINE

Global - <http://www.omron.com>

USA - <http://www.components.omron.com>