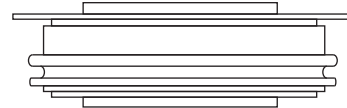


## Standard Recovery Diodes (Hockey PUK Version), 1100A/1400A

### FEATURES

- Wide current range
- High voltage ratings up to 3200 V
- High surge current capabilities
- Diffused junction
- Hockey PUK version
- Case style B-43(E-PUK), Nell's B-type Capsule
- Lead (Pb)-free



B-43(E-PUK)  
(Nell's B-type Capsule)

### TYPICAL APPLICATIONS

- Converters
- Power supplies
- Machine tool controls
- High power drives
- Medium traction applications

### PRODUCT SUMMARY

$I_{T(AV)}$	1100A/1400A
-------------	-------------

### MAJOR RATINGS AND CHARACTERISTICS

PARAMETER	TEST CONDITIONS	D1100B		UNIT
		08 TO 20	25 TO 32	
$I_{F(AV)}$		1400	1100	A
	$T_{hs}$	55	55	°C
$I_{F(RMS)}$		2500	2000	A
	$T_{hs}$	25	25	°C
$I_{FSM}$	50 HZ	13000	10500	A
	60 HZ	13610	11000	
$I^2t$	50 HZ	845	551	kA <sup>2</sup> s
	60 HZ	768	502	
$V_{RRM}$		800 to 2000	2500 to 3200	V
$T_J$	Typical	-40 to 175	-40 to 150	°C

### ELECTRICAL SPECIFICATIONS

#### VOLTAGE RATINGS

TYPE NUMBER	VOLTAGE CODE	$V_{RRM}$ , MAXIMUM REPETITIVE PEAK REVERSE VOLTAGE V	$V_{RSM}$ , MAXIMUM NON-REPETITIVE PEAK REVERSE VOLTAGE V	$I_{RRM}$ , MAXIMUM AT $T_J = T_J$ MAXIMUM mA
D1100B	08	800	900	35
	12	1200	1300	
	16	1600	1700	
	20	2000	2100	
	25	2500	2600	
	30	3000	3100	
	32	3200	3300	

## Nell High Power Products

FORWARD CONDUCTION							
PARAMETER	SYMBOL	TEST CONDITIONS			D1100B		UNIT
					08 to 20	25 to 32	
Maximum average forward current at heatsink temperature	$I_{F(AV)}$	180° conduction, half sine wave Double side (single side) cooled			1400 (795)	1100 (550)	A
					55 (85)	55 (85)	°C
Maximum RMS forward current	$I_{F(RMS)}$	25°C heatsink temperature double side cooled			2500	2000	A
Maximum peak, one cycle non-repetitive surge current	$I_{FSM}$	t = 10ms	No voltage reapplied	Sinusoidal half wave, initial $T_J = T_J$ maximum	13000	10500	A
		t = 8.3ms			13610	11000	
		t = 10ms	100% $V_{RRM}$ reapplied		10920	8820	
		t = 8.3ms			11430	9240	
Maximum $I^2t$ for fusing	$I^2t$	t = 10ms	No voltage reapplied		845	551	kA <sup>2</sup> s
		t = 8.3ms			768	502	
		t = 10ms	100% $V_{RRM}$ reapplied		601	389	
		t = 8.3ms			548	354	
Maximum $I^2\sqrt{t}$ for fusing	$I^2\sqrt{t}$	t = 0.1 to 10 ms, no voltage reapplied			8450	5510	kA <sup>2</sup> √s
Low level value of threshold voltage	$V_{F(TO)1}$	$(16.7\% \times \pi \times I_{F(AV)} < I < \pi \times I_{F(AV)})$ $T_J = T_J$ maximum			0.78	0.84	V
High level value of threshold voltage	$V_{F(TO)2}$	$(I > \pi \times I_{F(AV)})$ , $T_J = T_J$ maximum			0.94	0.98	
Low level value of forward slope resistance	$r_{t1}$	$(16.7\% \times \pi \times I_{F(AV)} < I < \pi \times I_{F(AV)})$ $T_J = T_J$ maximum			0.35	0.40	mΩ
High level value of forward slope resistance	$r_{t2}$	$(I > \pi \times I_{F(AV)})$ , $T_J = T_J$ maximum			0.26	0.38	
Maximum forward voltage drop	$V_{FM}$	$I_{pk} = 1500A$ , $T_J = T_J$ maximum, $t_p = 10$ ms sinusoidal wave			1.30	1.45	V

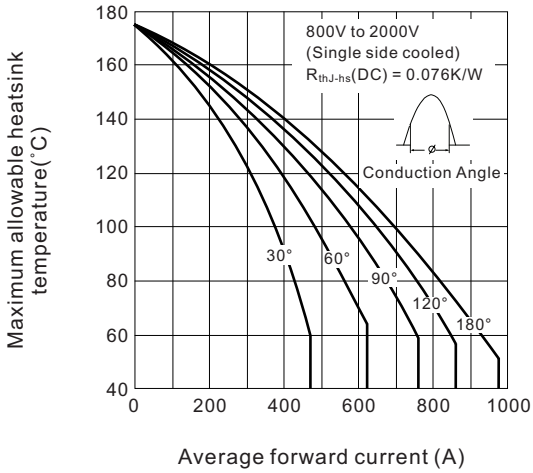
THERMAL AND MECHANICAL SPECIFICATIONS					
PARAMETER	SYMBOL	TEST CONDITIONS		VALUES	UNIT
Maximum junction operating temperature range	$T_J$	800V to 2000V		-40 to 175	°C
		2500V to 3200V		-40 to 150	
Maximum storage temperature range	$T_{stg}$			-40 to 200	
Maximum thermal resistance, junction to heatsink	$R_{thJ-hs}$	DC operation single side cooled		0.076	K/W
		DC operation double side cooled		0.038	
Mounting force, ±10%				9800 (1000)	N (kg)
Approximate weight				83	g
Case style		B-43 (E-PUK), Nell's B-type Capsule			

△ $R_{thJC}$ CONDUCTION						
CONDUCTION ANGEL	SINUSOIDAL CONDUCTION		RECTANGULAR CONDUCTION		TEST CONDUCTIONS	UNITS
	SINGLE SIDE	DOUBLE SIDE	SINGLE SIDE	DOUBLE SIDE		
180°	0.007	0.007	0.005	0.005	$T_J = T_J$ maximum	K/W
120°	0.008	0.008	0.008	0.008		
90°	0.010	0.010	0.011	0.011		
60°	0.015	0.015	0.016	0.016		
30°	0.026	0.026	0.026	0.026		

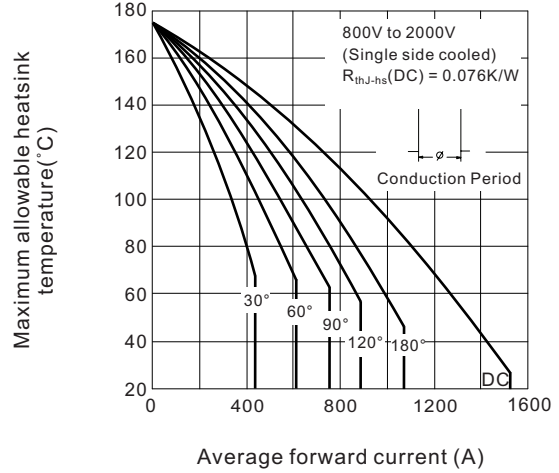
**Note**

• The table above shows the increment of thermal resistance  $R_{thJ-hs}$  when devices operate at different conduction angles than DC

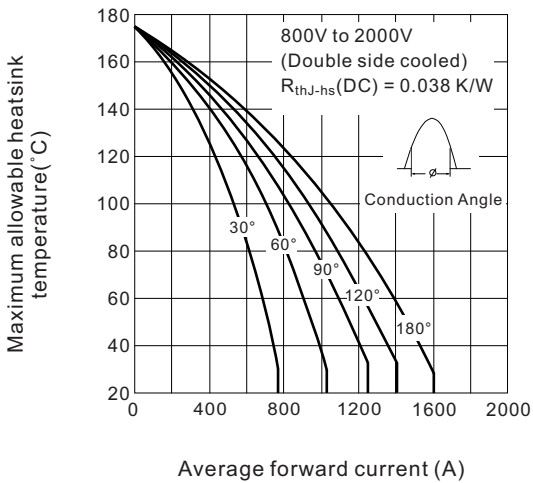
**Fig.1 Current ratings characteristics**



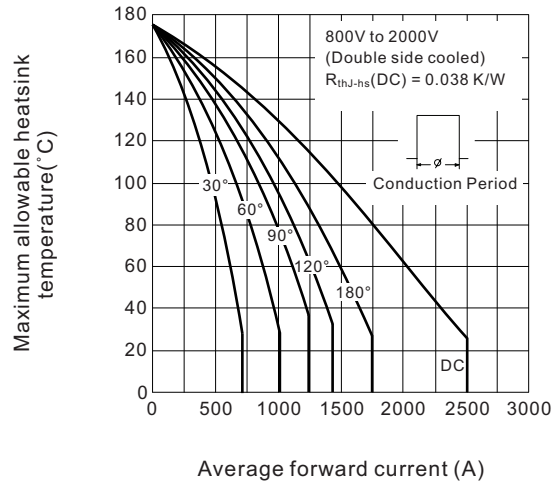
**Fig.2 Current ratings characteristics**



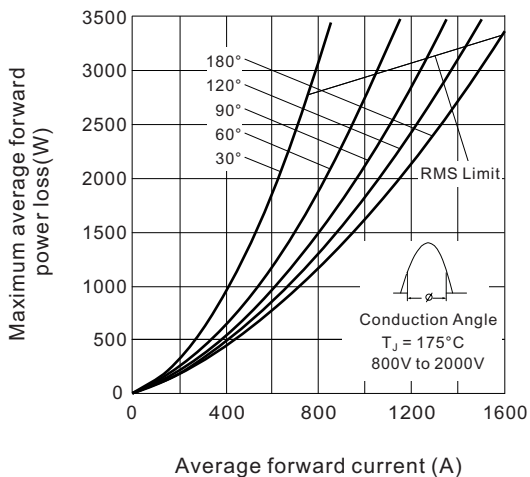
**Fig.3 Current ratings characteristics**



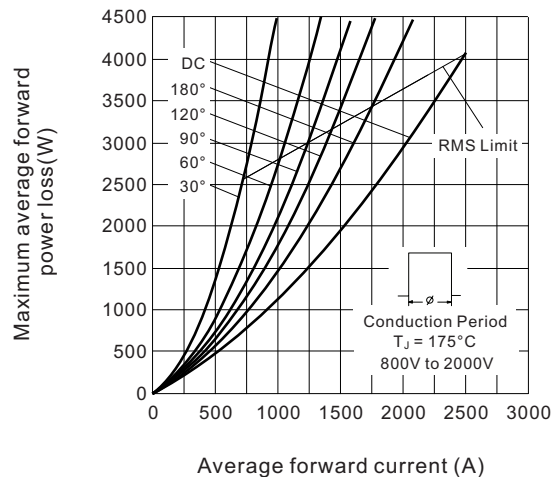
**Fig.4 Current ratings characteristics**



**Fig.5 Forward power loss characteristics**

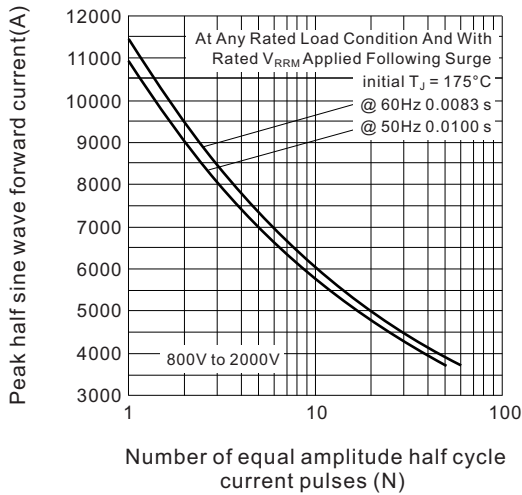


**Fig.6 Forward power loss characteristics**

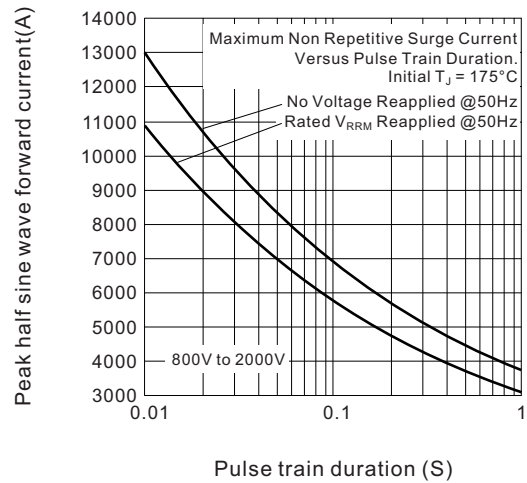


## Nell High Power Products

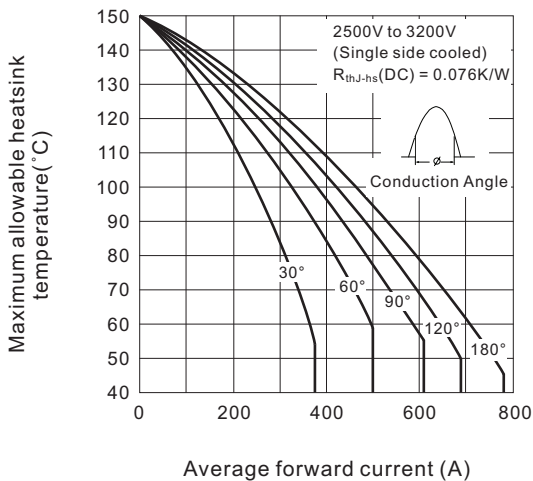
**Fig.7 Maximum non-repetitive surge current single and double side cooled**



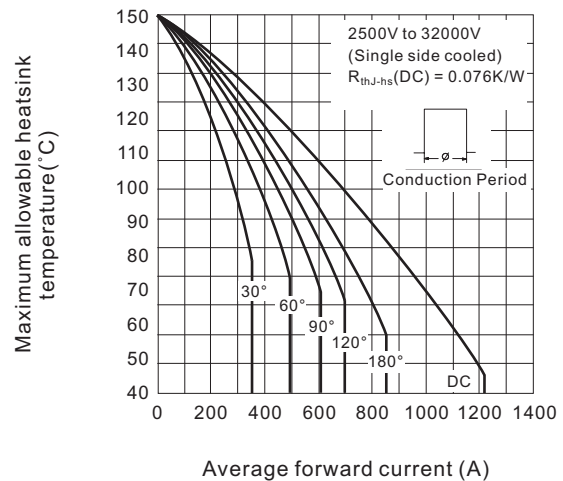
**Fig.8 Maximum non-repetitive surge current single and double side cooled**



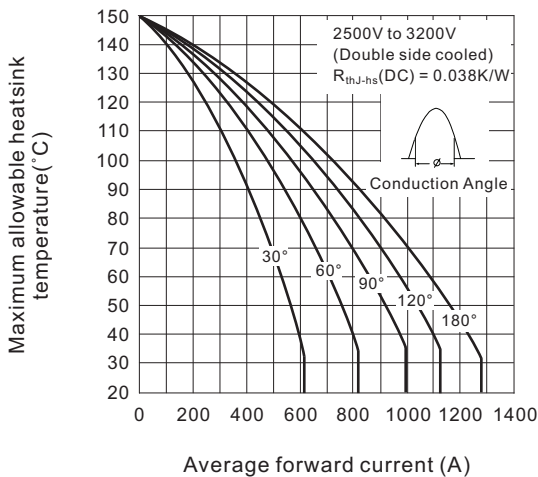
**Fig.9 Current ratings characteristics**



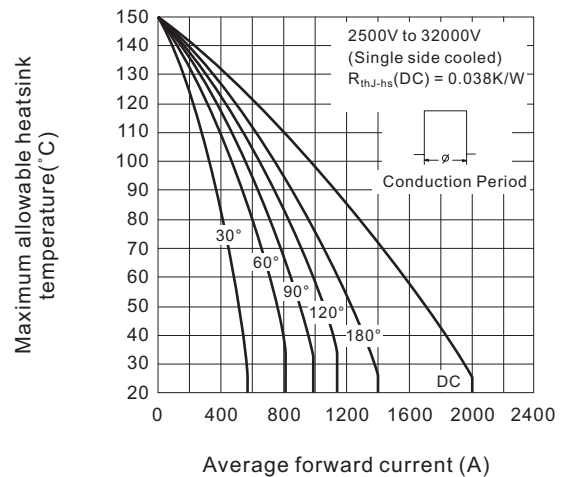
**Fig.10 Current ratings characteristics**



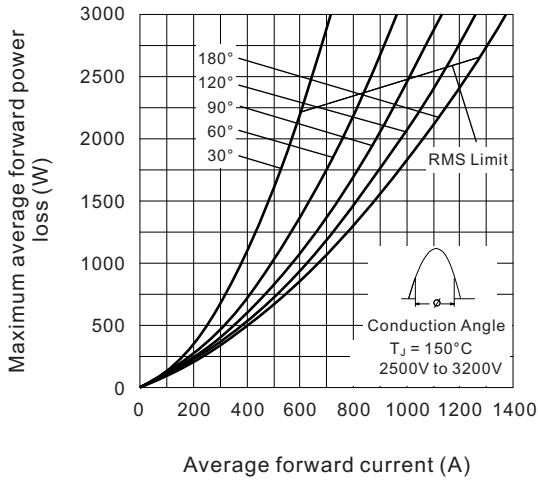
**Fig.11 Current ratings characteristics**



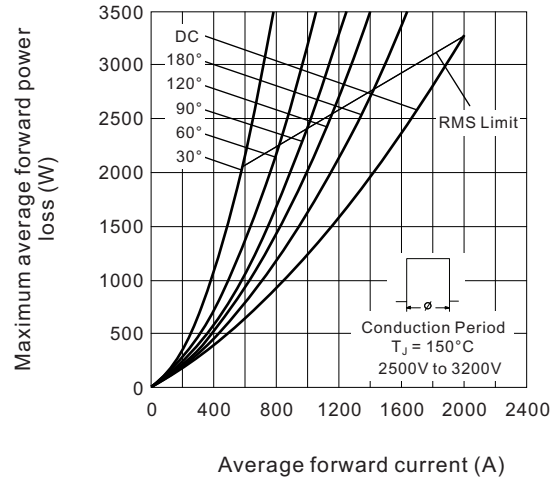
**Fig.12 Current ratings characteristics**



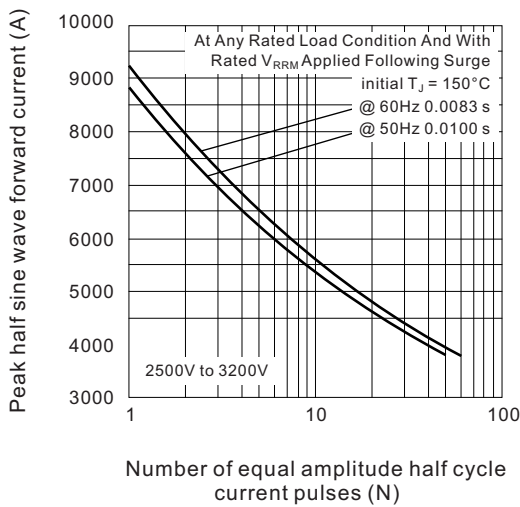
**Fig.13 Forward power loss characteristics**



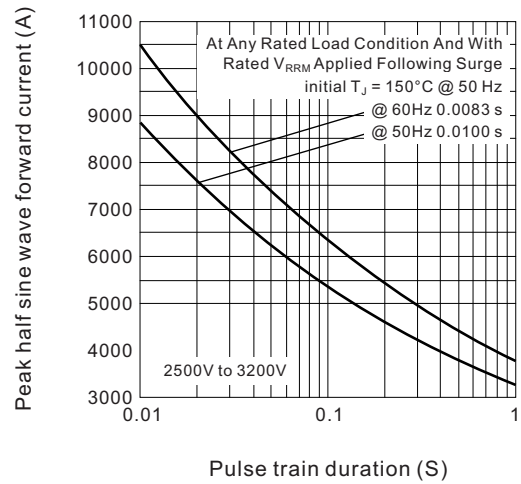
**Fig.14 Forward power loss characteristics**



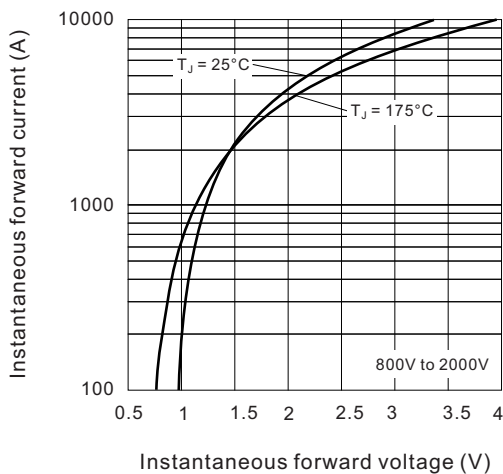
**Fig.15 Maximum non-repetitive surge current single and double side cooled**



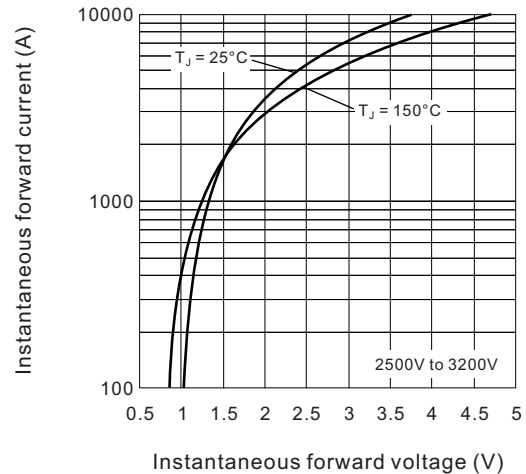
**Fig.16 Maximum non-repetitive surge current single and double side cooled**



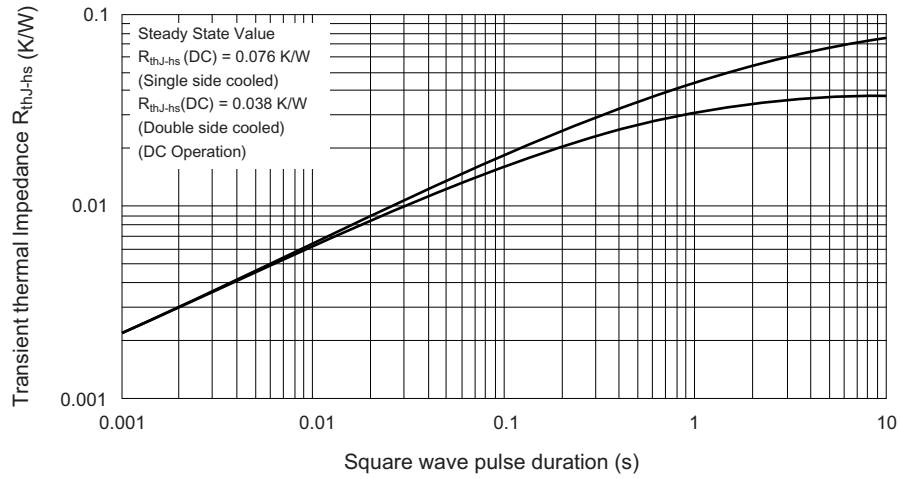
**Fig.17 Forward voltage drop characteristics**



**Fig.18 Forward voltage drop characteristics**



**Fig.19 Thermal Impedance  $R_{thJ-hs}$  characteristics**

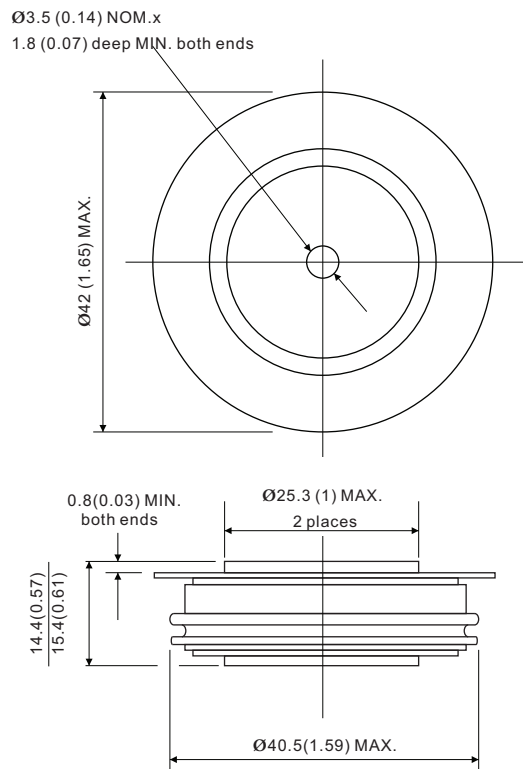


### ORDERING INFORMATION TABLE

Device code	<b>D</b>	<b>1100</b>	<b>B</b>	<b>20</b>
	①	②	③	④

- ① - "D" for standard recovery diode
- ② - Maximum average forward current, "1100" for 1400A and 1100A
- ③ - Case style : "B" for Nell's B-type Capsule, B-43 (E-PUK)
- ④ - Voltage code, code x 100 =  $V_{RRM}$

**B-43 (E-PUK), Nell's B-type Capsule**



All dimensions in millimeters (inches)

