

SK4001WA-SK4007WA

Surface Mount General Purpose Silicon Rectifiers

Reverse Voltage - 50 to 1000 V

Forward Current - 1 A

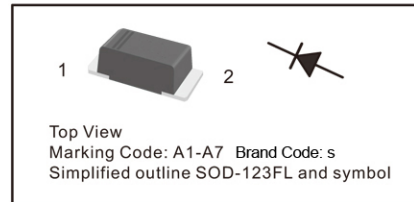

● **Maximum Ratings and Electrical characteristics**

Ratings at 25 °C ambient temperature unless otherwise specified.

Single phase half-wave 60 Hz, resistive or inductive load, for capacitive load current derate by 20 %.

Parameter	Symbols	SK4001WA	SK4002WA	SK4003WA	SK4004WA	SK4005WA	SK4006WA	SK4007WA	Units
Maximum Repetitive Peak Reverse Voltage	V_{RRM}	50	100	200	400	600	800	1000	V
Maximum RMS voltage	V_{RMS}	35	70	140	280	420	560	700	V
Maximum DC Blocking Voltage	V_{DC}	50	100	200	400	600	800	1000	V
Maximum Average Forward Rectified Current at $T_a = 65\text{ °C}$	$I_{F(AV)}$	1							A
Peak Forward Surge Current 8.3 ms Single Half Sine Wave Superimposed on Rated Load (JEDEC Method)	I_{FSM}	25							A
Maximum Instantaneous Forward Voltage at 1 A	V_F	1.1							V
Maximum DC Reverse Current at Rated DC Blocking Voltage $T_a = 25\text{ °C}$ $T_a = 125\text{ °C}$	I_R	5 100							μA
Typical Junction Capacitance ¹⁾	C_j	4							pF
Typical Thermal Resistance ²⁾	$R_{\theta JA}$	180							°C/W
Operating and Storage Temperature Range	T_J, T_{stg}	-55 ~ +150							°C

1) Measured at 1 MHz and applied reverse voltage of 4 V D.C

2) Thermal resistance from junction to ambient at 0.375" (9.5 mm) lead length, P.C.B. mounted

SK4001WA-SK4007WA

Fig.1 Forward Current Derating Curve

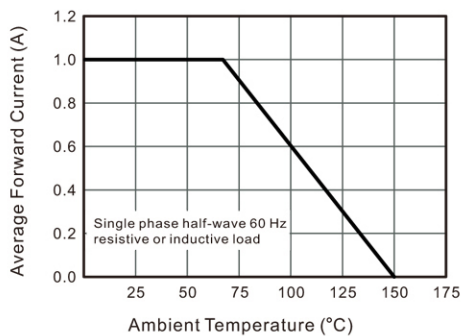

Fig.2 Typical Instantaneous Reverse Characteristics

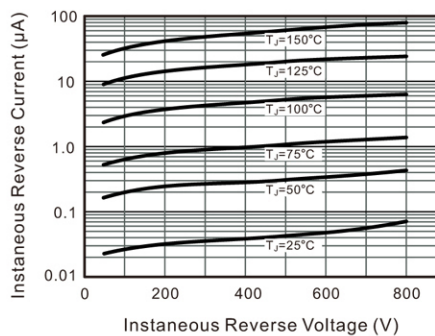

Fig.3 Typical Forward Characteristic

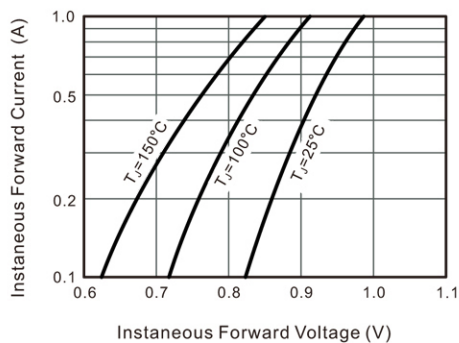
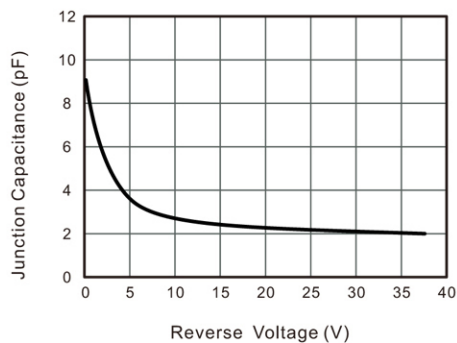

Fig.4 Typical Junction Capacitance



SK4001WA-SK4007WA

PACKAGE OUTLINE

Plastic surface mounted package; 2 leads

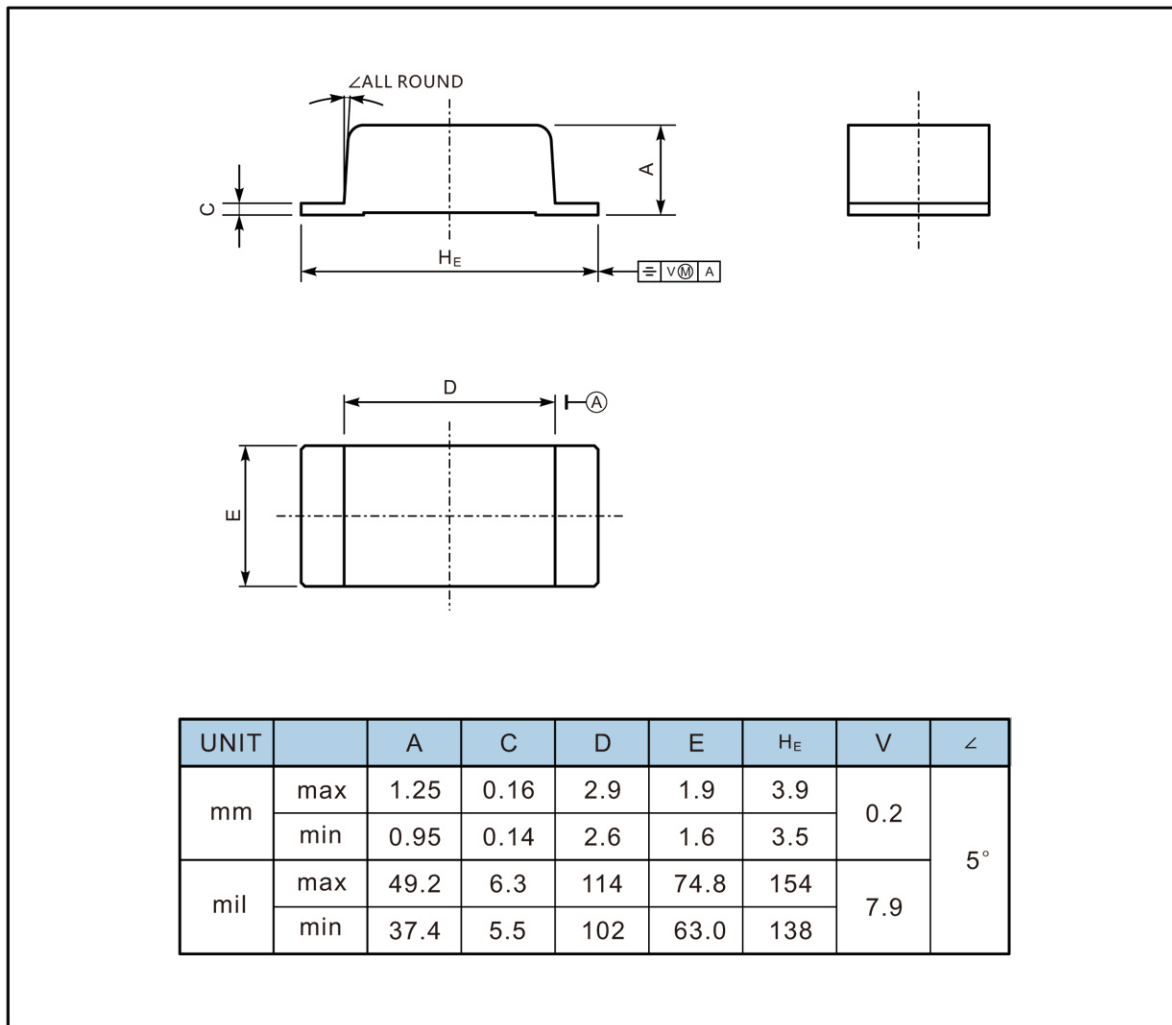

The recommended mounting pad size

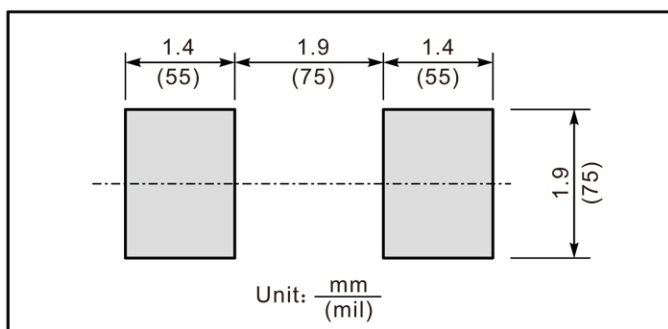

Marking

Type number	Marking code
SK 4001WA	A1
SK 4002WA	A2
SK 4003WA	A3
SK 4004WA	A4
SK 4005WA	A5
SK 4006WA	A6
SK 4007WA	A7

SK4001WA-SK4007WA

• Recommended condition of flow soldering

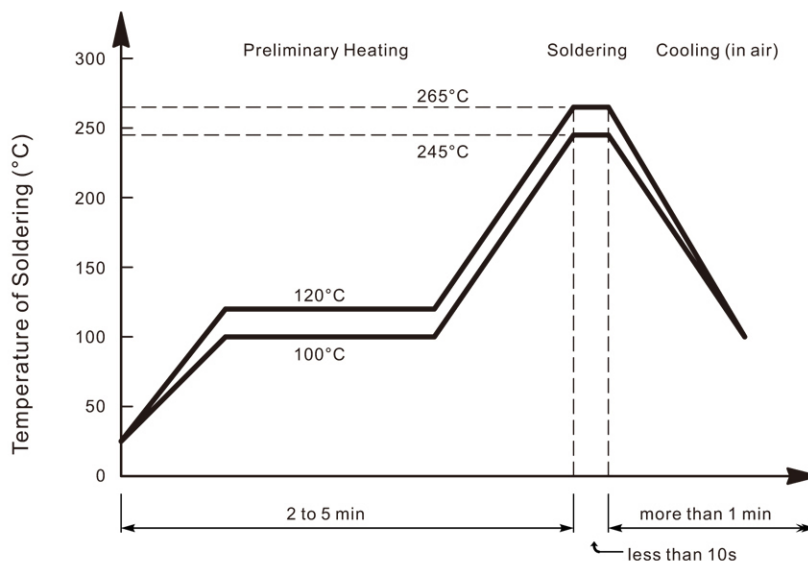

• Recommended condition of reflow soldering

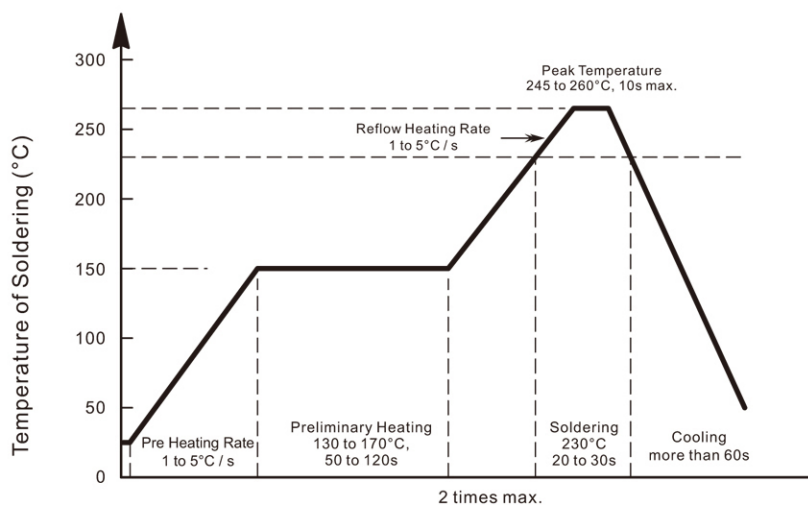

Recommended peak temperature is over 245 °C. If peak temperature is below 245 °C, you may adjust the following parameters; time length of peak temperature (longer), time length of soldering (longer), thickness of solder paste (thicker)

• Condition of hand soldering

Temperature: 370°C

Time: 3s max.

Times: one time

• Remark:

Lead free solder paste (96.5Sn/3.0Ag/0.5Cu)