

DTA114E SERIES

Preferred Devices

Bias Resistor Transistor

PNP Silicon Surface Mount Transistor with Monolithic Bias Resistor Network

This new series of digital transistors is designed to replace a single device and its external resistor bias network. The BRT (Bias Resistor Transistor) contains a single transistor with a monolithic bias network consisting of two resistors; a series base resistor and a base-emitter resistor. The BRT eliminates these individual components by integrating them into a single device. The use of a BRT can reduce both system cost and board space. The device is housed in the TO-92 package which is designed for through hole applications.



ON Semiconductor

<http://onsemi.com>

PNP SILICON BIAS RESISTOR TRANSISTOR

MAXIMUM RATINGS ($T_A = 25^\circ\text{C}$ unless otherwise noted)

Rating	Symbol	Value	Unit
Collector-Base Voltage	V_{CBO}	50	Vdc
Collector-Emitter Voltage	V_{CEO}	50	Vdc
Collector Current	I_C	100	mAdc
Total Power Dissipation @ $T_A = 25^\circ\text{C}$ (1.) Derate above 25°C	P_D	350 2.81	mW mW/°C

THERMAL CHARACTERISTICS

Characteristic	Symbol	Value	Unit
Thermal Resistance, Junction to Ambient (surface mounted)	$R_{\theta JA}$	357	°C/W
Operating and Storage Temperature Range	T_J, T_{stg}	-55 to +150	°C
Maximum Temperature for Soldering Purposes, Time in Solder Bath	T_L	260 10	°C Sec

DEVICE MARKING AND RESISTOR VALUES

Device	Marking	R1 (K)	R2 (K)	Shipping
DTA114E	DTA114E	10	10	5000/Box
DTA124E	DTA124E	22	22	
DTA144E	DTA144E	47	47	
DTA114Y	DTA114Y	10	47	
DTA114T	DTA114T	10	∞	
DTA143T	DTA143T	4.7	∞	
DTB113E	DTB113E	1.0	1.0	
DTA123E	DTA123E	2.2	2.2	
DTA143E	DTA143E	4.7	4.7	
DTA143Z	DTA143Z	4.7	47	

1. Device mounted on a FR-4 glass epoxy printed circuit board using the minimum recommended footprint.

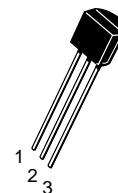

CASE 29
TO-92 (TO-226)
STYLE 1

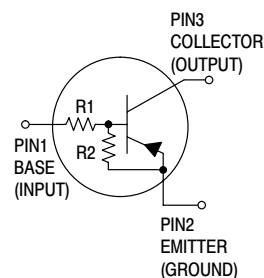

Preferred devices are recommended choices for future use and best overall value.

DTA114E SERIES

ELECTRICAL CHARACTERISTICS (T_A = 25°C unless otherwise noted)

Characteristic	Symbol	Min	Typ	Max	Unit	
OFF CHARACTERISTICS						
Collector–Base Cutoff Current (V _{CB} = 50 V, I _E = 0)	I _{CBO}	—	—	100	nAdc	
Collector–Emitter Cutoff Current (V _{CE} = 50 V, I _B = 0)	I _{CEO}	—	—	500	nAdc	
Emitter–Base Cutoff Current (V _{EB} = 6.0 V, I _C = 0)	DTA114E DTA124E DTA144E DTA114Y DTA114T DTA143T DTB113E DTA123E DTA143E DTA143Z	I _{EBO}	— — — — — — — — — —	— — — — — — — — — —	0.5 0.2 0.1 0.2 0.9 1.9 4.3 2.3 1.5 0.18	mAdc
Collector–Base Breakdown Voltage (I _C = 10 μA, I _E = 0)	V _{(BR)CBO}	50	—	—	Vdc	
Collector–Emitter Breakdown Voltage ^(2.) (I _C = 2.0 mA, I _B = 0)	V _{(BR)CEO}	50	—	—	Vdc	
ON CHARACTERISTICS ^(2.)						
DC Current Gain (V _{CE} = 10 V, I _C = 5.0 mA)	DTA114E DTA124E DTA144E DTA114Y DTA114T DTA143T DTB113E DTA123E DTA143E DTA143Z	h _{FE}	35 60 80 80 160 160 3.0 8.0 15 80	60 100 140 140 250 250 5.0 15 27 140	— — — — — — — — — —	
Collector–Emitter Saturation Voltage (I _C = 10 mA, I _E = 0.3 mA) DTA144E/DTA114Y DTB113E/DTA143E (I _C = 10 mA, I _B = 5 mA) DTA123E (I _C = 10 mA, I _B = 1 mA) DTA114T/DTA143T/ DTA143Z/DTA124E		V _{CE(sat)}	—	—	0.25	Vdc
Output Voltage (on) (V _{CC} = 5.0 V, V _B = 2.5 V, R _L = 1.0 kΩ) (V _{CC} = 5.0 V, V _B = 3.5 V, R _L = 1.0 kΩ)	DTA114E DTA124E DTA114Y DTA114T DTA143T DTB113E DTA123E DTA143E DTA143Z DTA144E	V _{OL}	— — — — — — — — — —	— — — — — — — — — —	0.2 0.2 0.2 0.2 0.2 0.2 0.2 0.2 0.2 0.2	Vdc

2. Pulse Test: Pulse Width < 300 μs, Duty Cycle < 2.0%

DTA114E SERIES

ELECTRICAL CHARACTERISTICS (T_A = 25°C unless otherwise noted) (Continued)

Characteristic	Symbol	Min	Typ	Max	Unit	
Output Voltage (off) (V _{CC} = 5.0 V, V _B = 0.5 V, R _L = 1.0 kΩ) (V _{CC} = 5.0 V, V _B = 0.05 V, R _L = 1.0 kΩ) (V _{CC} = 5.0 V, V _B = 0.25 V, R _L = 1.0 kΩ)	DTA114T DTA113T DTA144E DTA114Y DTA143Z DTB113E DTA114T DTA143T DTA123E DTA143E	V _{OH}	4.9	—	—	Vdc
Input Resistor	DTA114E DTA124E DTA144E DTA114Y DTA114T DTA143T DTB113E DTA123E DTA143E DTA143Z	R ₁	7.0 15.4 32.9 7.0 7.0 3.3 0.7 1.5 3.3 3.3	10 22 47 10 10 4.7 1.0 2.2 4.7 4.7	13 28.6 61.1 13 13 6.1 1.3 2.9 6.1 6.1	kΩ
Resistor Ratio	DTA114E/DTA124E/DTA144E DTA114Y DTA114T/DTA143T DTB113E/DTA123E/DTA143E DTA143Z	R ₁ /R ₂	0.8 0.17 — 0.8 0.055	1.0 0.21 — 1.0 0.1	1.2 0.25 — 1.2 0.185	

DTA114E SERIES

TYPICAL ELECTRICAL CHARACTERISTICS DTA114E

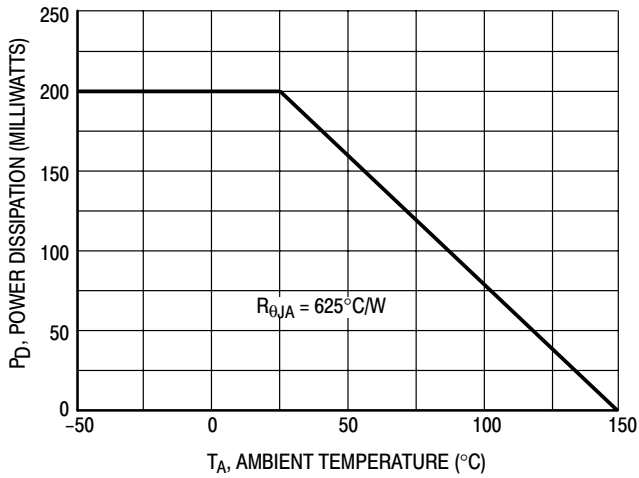

Figure 1. Derating Curve

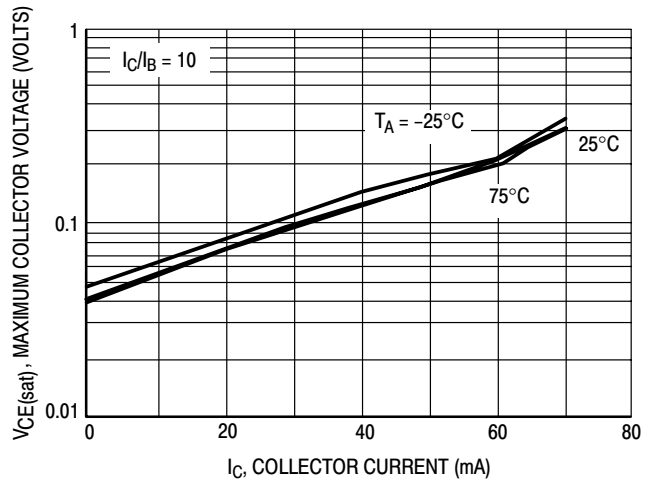

Figure 2. V_{CE(sat)} versus I_C

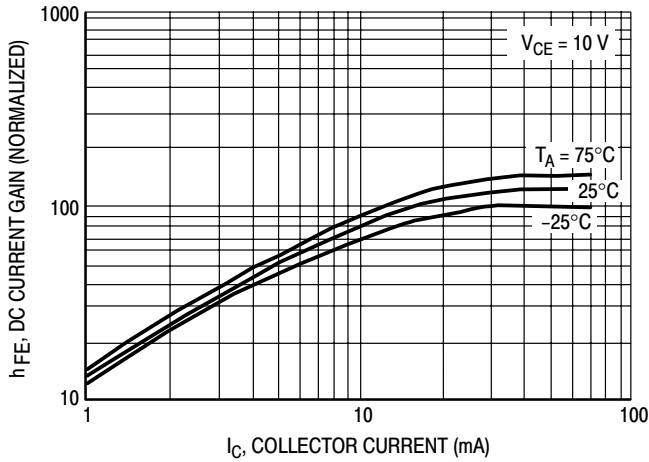

Figure 3. DC Current Gain

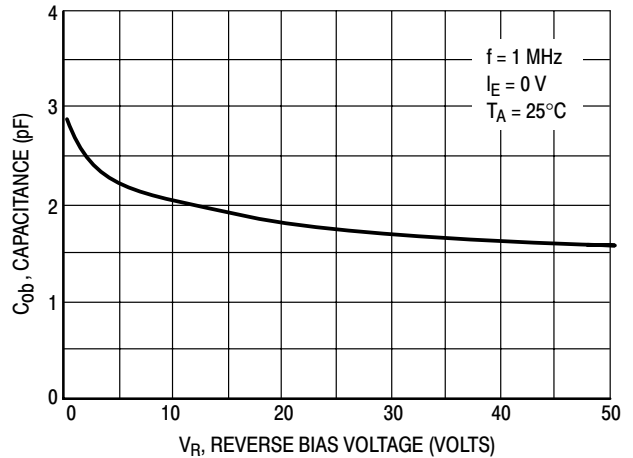

Figure 4. Output Capacitance

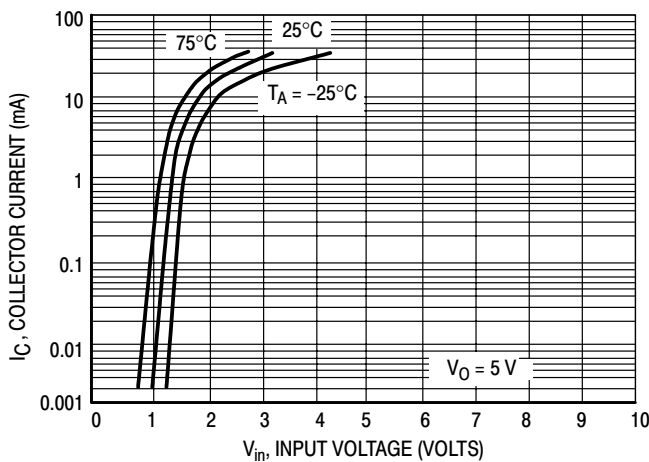

Figure 5. Output Current versus Input Voltage

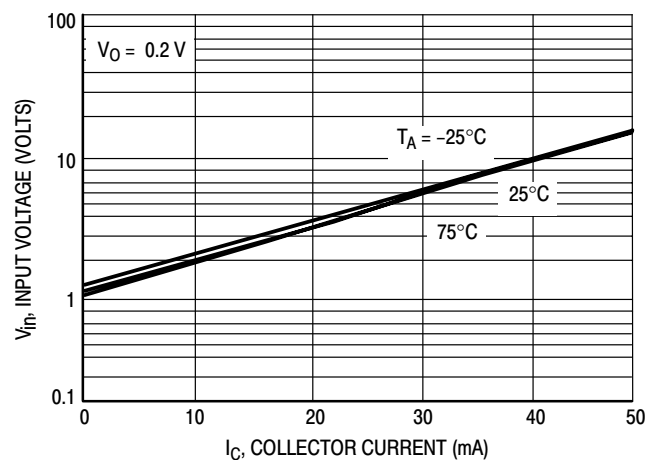

Figure 6. Input Voltage versus Output Current

DTA114E SERIES

TYPICAL ELECTRICAL CHARACTERISTICS DTA124E

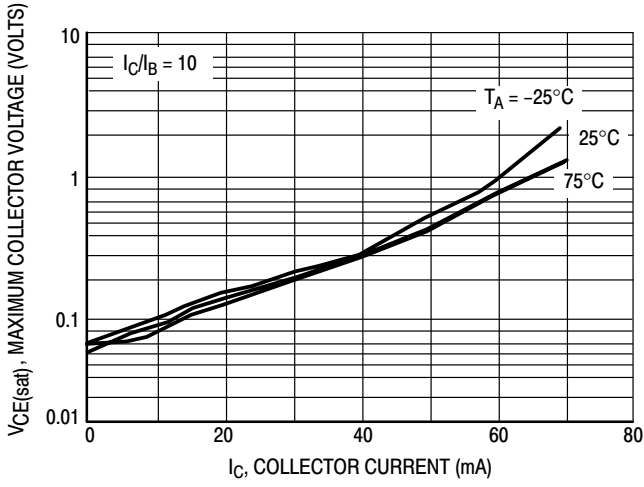

Figure 7. $V_{CE(sat)}$ versus I_C

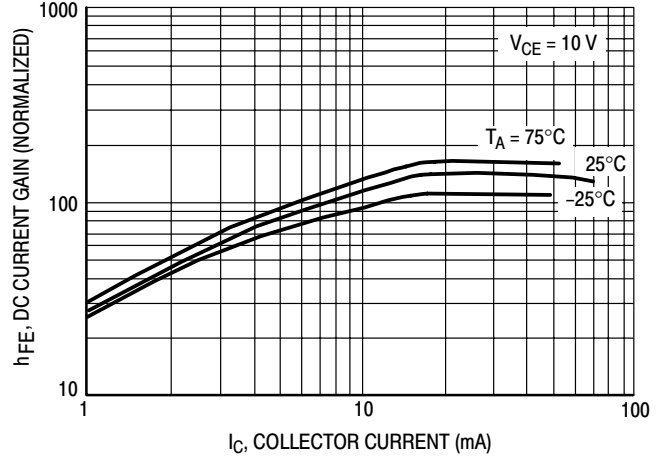

Figure 8. DC Current Gain

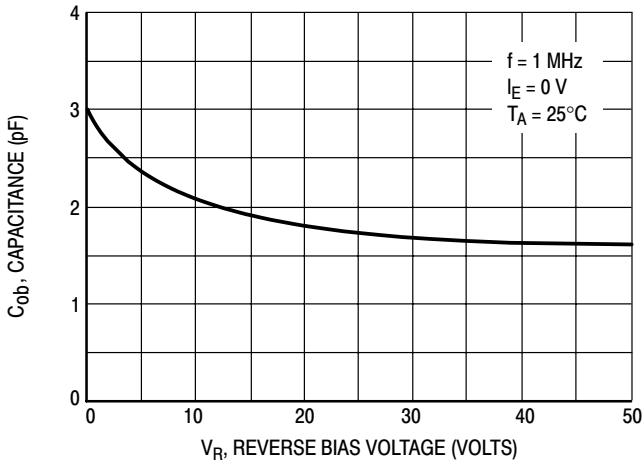

Figure 9. Output Capacitance

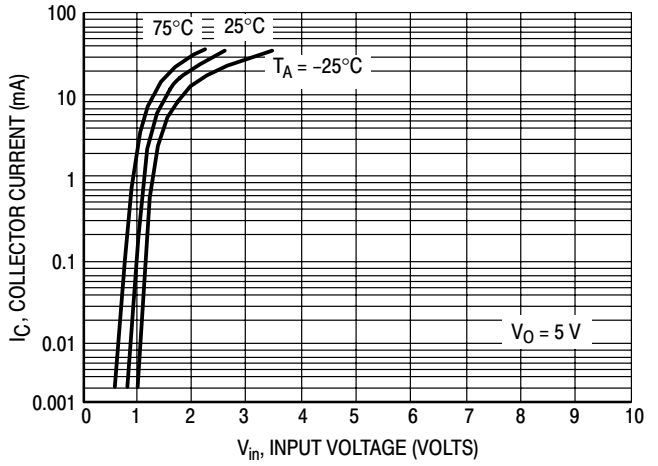

Figure 10. Output Current versus Input Voltage

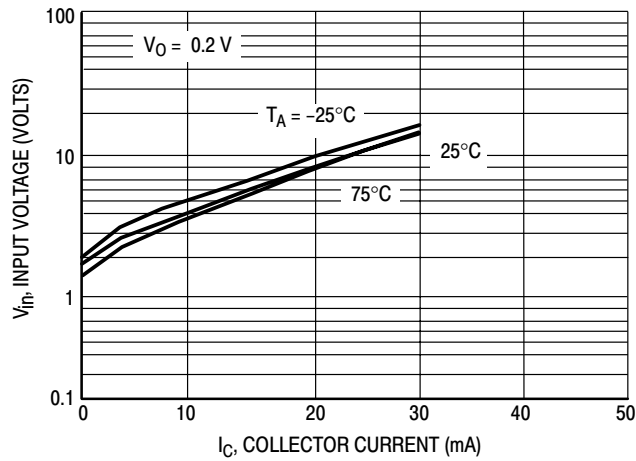

Figure 11. Input Voltage versus Output Current

DTA114E SERIES

TYPICAL ELECTRICAL CHARACTERISTICS DTA144E

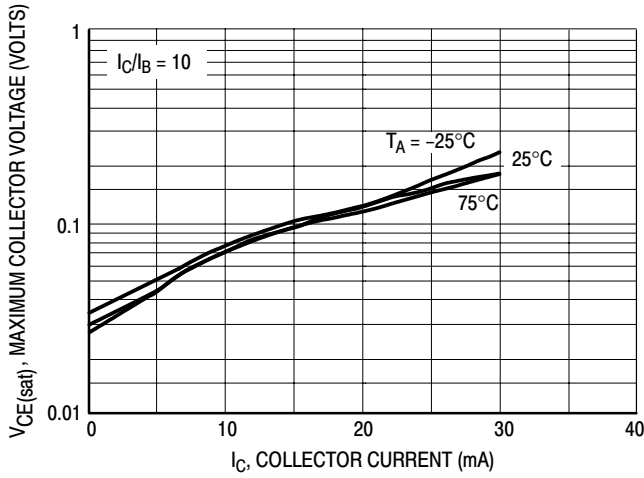

Figure 12. $V_{CE(sat)}$ versus I_C

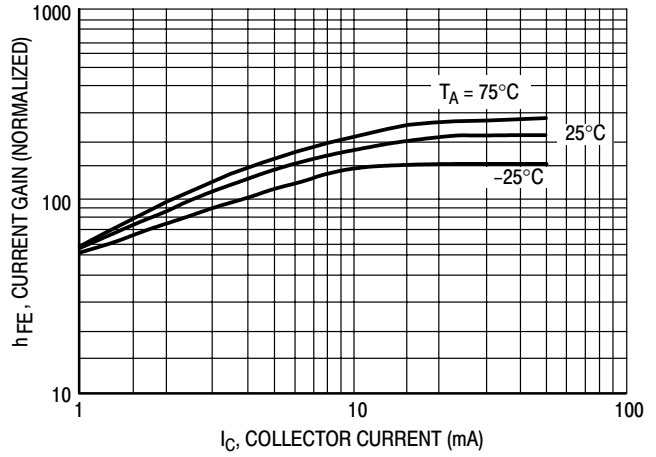

Figure 13. DC Current Gain

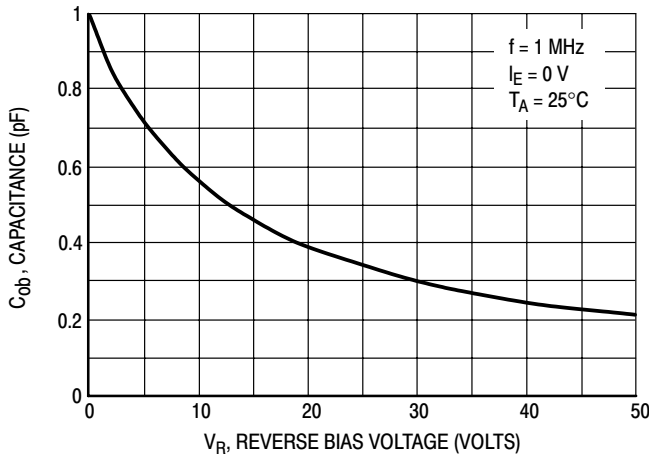

Figure 14. Output Capacitance

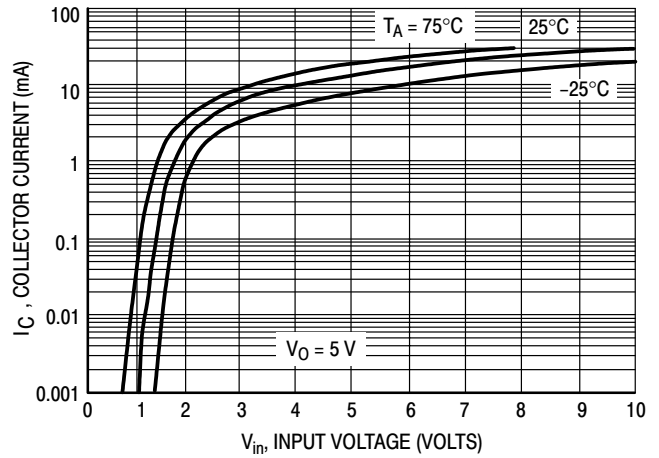

Figure 15. Output Current versus Input Voltage

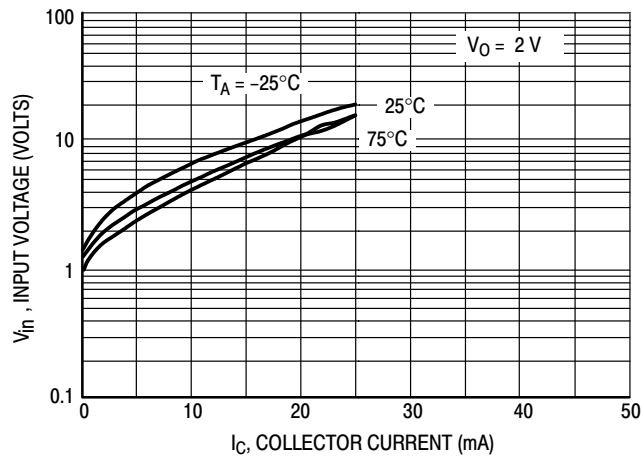

Figure 16. Input Voltage versus Output Current

DTA114E SERIES

TYPICAL ELECTRICAL CHARACTERISTICS DTA114Y

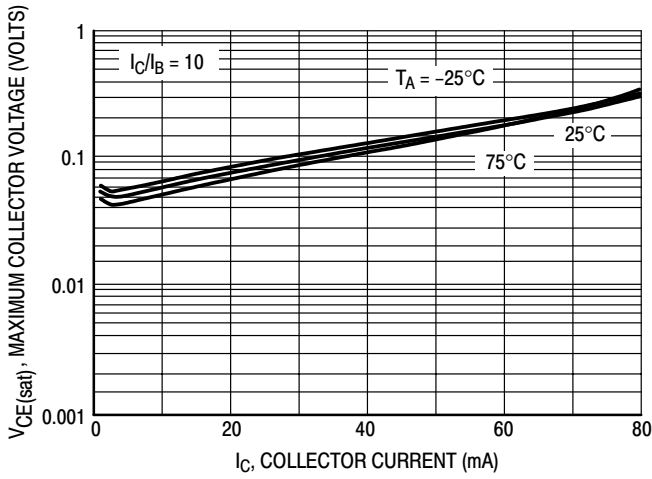

Figure 17. $V_{CE(sat)}$ versus I_C

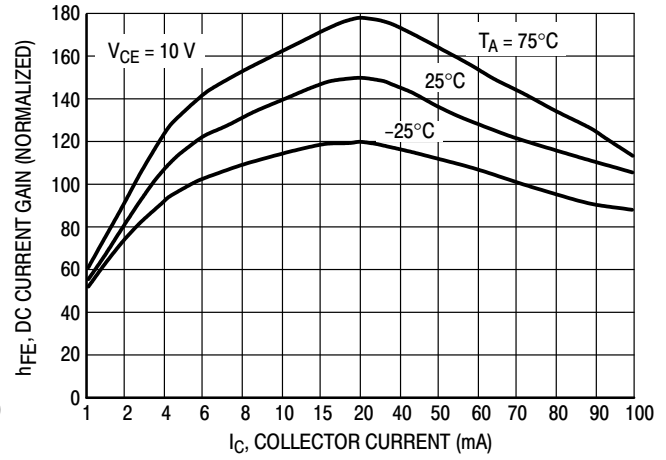

Figure 18. DC Current Gain

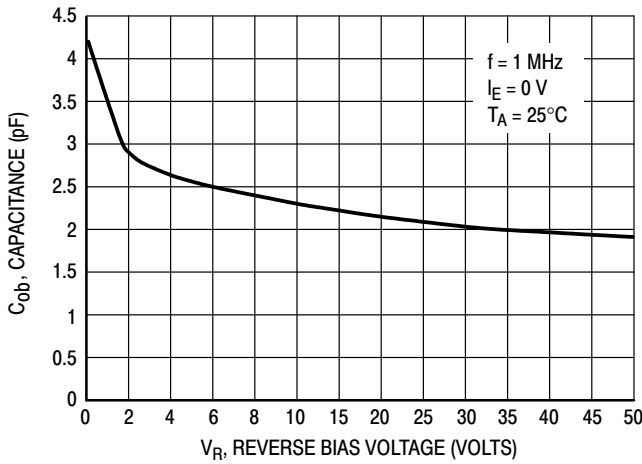

Figure 19. Output Capacitance

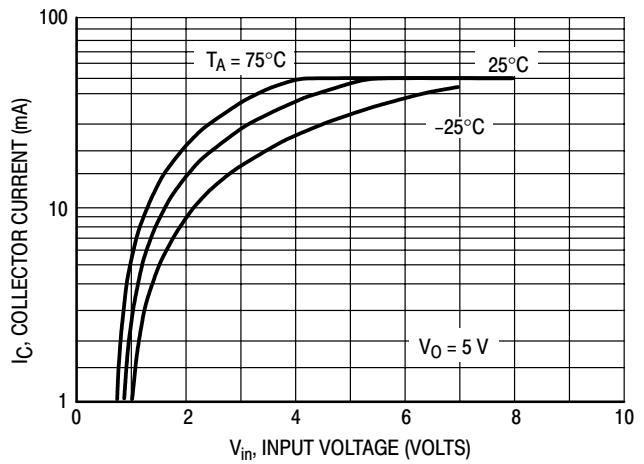

Figure 20. Output Current versus Input Voltage

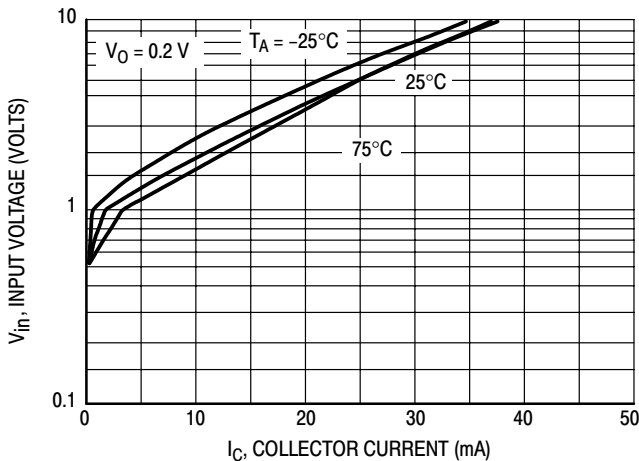

Figure 21. Input Voltage versus Output Current

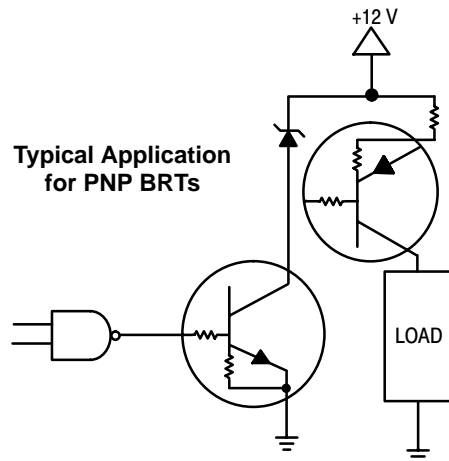
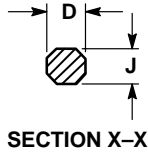
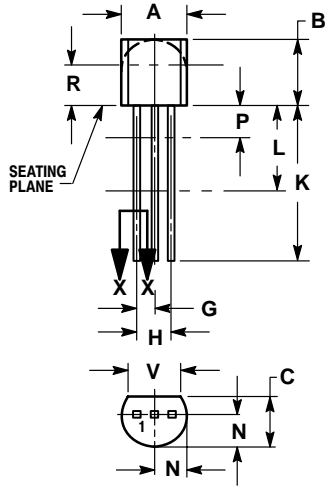

Figure 22. Inexpensive, Unregulated Current Source

DTA114E SERIES

PACKAGE DIMENSIONS

TO-92
(TO-226)
CASE 29-11
ISSUE AL



- NOTES:
1. DIMENSIONING AND TOLERANCING PER ANSI Y14.5M, 1982.
 2. CONTROLLING DIMENSION: INCH.
 3. CONTOUR OF PACKAGE BEYOND DIMENSION R IS UNCONTROLLED.
 4. LEAD DIMENSION IS UNCONTROLLED IN P AND BEYOND DIMENSION K MINIMUM.

DIM	INCHES		MILLIMETERS	
	MIN	MAX	MIN	MAX
A	0.175	0.205	4.45	5.20
B	0.170	0.210	4.32	5.33
C	0.125	0.165	3.18	4.19
D	0.016	0.021	0.407	0.533
G	0.045	0.055	1.15	1.39
H	0.095	0.105	2.42	2.66
J	0.015	0.020	0.39	0.50
K	0.500	---	12.70	---
L	0.250	---	6.35	---
N	0.080	0.105	2.04	2.66
P	---	0.100	---	2.54
R	0.115	---	2.93	---
V	0.135	---	3.43	---

- | | | | | |
|---|--|--|--|---|
| <p>STYLE 1:
PIN 1. EMITTER
2. BASE
3. COLLECTOR</p> | <p>STYLE 2:
PIN 1. BASE
2. EMITTER
3. COLLECTOR</p> | <p>STYLE 3:
PIN 1. ANODE
2. ANODE
3. CATHODE</p> | <p>STYLE 4:
PIN 1. CATHODE
2. CATHODE
3. ANODE</p> | <p>STYLE 5:
PIN 1. DRAIN
2. SOURCE
3. GATE</p> |
| <p>STYLE 6:
PIN 1. GATE
2. SOURCE & SUBSTRATE
3. DRAIN</p> | <p>STYLE 7:
PIN 1. SOURCE
2. DRAIN
3. GATE</p> | <p>STYLE 8:
PIN 1. DRAIN
2. GATE
3. SOURCE & SUBSTRATE</p> | <p>STYLE 9:
PIN 1. BASE 1
2. EMITTER
3. BASE 2</p> | <p>STYLE 10:
PIN 1. CATHODE
2. GATE
3. ANODE</p> |
| <p>STYLE 11:
PIN 1. ANODE
2. CATHODE & ANODE
3. CATHODE</p> | <p>STYLE 12:
PIN 1. MAIN TERMINAL 1
2. GATE
3. MAIN TERMINAL 2</p> | <p>STYLE 13:
PIN 1. ANODE 1
2. GATE
3. CATHODE 2</p> | <p>STYLE 14:
PIN 1. EMITTER
2. COLLECTOR
3. BASE</p> | <p>STYLE 15:
PIN 1. ANODE 1
2. CATHODE
3. ANODE 2</p> |

Thermal Clad is a trademark of the Bergquist Company

ON Semiconductor and  are trademarks of Semiconductor Components Industries, LLC (SCILLC). SCILLC reserves the right to make changes without further notice to any products herein. SCILLC makes no warranty, representation or guarantee regarding the suitability of its products for any particular purpose, nor does SCILLC assume any liability arising out of the application or use of any product or circuit, and specifically disclaims any and all liability, including without limitation special, consequential or incidental damages. "Typical" parameters which may be provided in SCILLC data sheets and/or specifications can and do vary in different applications and actual performance may vary over time. All operating parameters, including "Typicals" must be validated for each customer application by customer's technical experts. SCILLC does not convey any license under its patent rights nor the rights of others. SCILLC products are not designed, intended, or authorized for use as components in systems intended for surgical implant into the body, or other applications intended to support or sustain life, or for any other application in which the failure of the SCILLC product could create a situation where personal injury or death may occur. Should Buyer purchase or use SCILLC products for any such unintended or unauthorized application, Buyer shall indemnify and hold SCILLC and its officers, employees, subsidiaries, affiliates, and distributors harmless against all claims, costs, damages, and expenses, and reasonable attorney fees arising out of, directly or indirectly, any claim of personal injury or death associated with such unintended or unauthorized use, even if such claim alleges that SCILLC was negligent regarding the design or manufacture of the part. SCILLC is an Equal Opportunity/Affirmative Action Employer.

PUBLICATION ORDERING INFORMATION

NORTH AMERICA Literature Fulfillment:
Literature Distribution Center for ON Semiconductor
P.O. Box 5163, Denver, Colorado 80217 USA
Phone: 303-675-2175 or 800-344-3860 Toll Free USA/Canada
Fax: 303-675-2176 or 800-344-3867 Toll Free USA/Canada
Email: ONlit@hibbertco.com
Fax Response Line: 303-675-2167 or 800-344-3810 Toll Free USA/Canada

N. American Technical Support: 800-282-9855 Toll Free USA/Canada

EUROPE: LDC for ON Semiconductor – European Support
German Phone: (+1) 303-308-7140 (Mon-Fri 2:30pm to 7:00pm CET)
Email: ONlit-german@hibbertco.com
French Phone: (+1) 303-308-7141 (Mon-Fri 2:00pm to 7:00pm CET)
Email: ONlit-french@hibbertco.com
English Phone: (+1) 303-308-7142 (Mon-Fri 12:00pm to 5:00pm GMT)
Email: ONlit@hibbertco.com

EUROPEAN TOLL-FREE ACCESS*: 00-800-4422-3781
*Available from Germany, France, Italy, UK

CENTRAL/SOUTH AMERICA:
Spanish Phone: 303-308-7143 (Mon-Fri 8:00am to 5:00pm MST)
Email: ONlit-spanish@hibbertco.com

ASIA/PACIFIC: LDC for ON Semiconductor – Asia Support
Phone: 303-675-2121 (Tue-Fri 9:00am to 1:00pm, Hong Kong Time)
Toll Free from Hong Kong & Singapore:
001-800-4422-3781
Email: ONlit-asia@hibbertco.com

JAPAN: ON Semiconductor, Japan Customer Focus Center
4-32-1 Nishi-Gotanda, Shinagawa-ku, Tokyo, Japan 141-0031
Phone: 81-3-5740-2745
Email: r14525@onsemi.com

ON Semiconductor Website: <http://onsemi.com>

For additional information, please contact your local Sales Representative.

Device DTA143Z

Bias Resistor Transistor

[Data Sheet](#) DTA114E/D - 106.0 (kb)

[Models](#) | [Reference Manuals](#)

This new series of digital transistors is designed to replace a single device and its external resistor bias network. The BRT (Bias Resistor Transistor) contains a single transistor with a monolithic bias network consisting of two resistors; a series base resistor and a base-emitter resistor. The BRT eliminates these individual components by integrating them into a single device. The use of a BRT can reduce both system cost and board space. The device is housed in the TO-92 package which is designed for through hole applications.

Orderable Devices

Action	Device	Package Type	Pins	Case Outline	Status	Budgetary Price/Unit	Qty.
Order Samples Buy Now	DTA143Z	Bulk	3	29-11	Active	\$0.067	5,000
Order Samples	DTA143ZRLRA	Tape and Reel	3	29-11	Active	\$0.067	2,000
Order Samples	DTA143ZRLRM	Tape and Ammunition Box	3	29-11	Active	\$0.067	2,000
Order Samples	DTA143ZRLRP	Tape and Ammunition Box	3	29-11	Active	\$0.067	2,000

Models

Document Title	Document ID	Rev
Discrete Model Library File - SPICE3	ONDISCRETES.SP3 - 216.0KB	0
Discrete Model Library - PSpice	ONDISCRETES.LIB - 219.0KB	0

Reference Manuals

Document Title	Document ID	Rev
Tape & Reel and Packaging Specifications for Small-Signal Transistors, FETs and Diodes	DL126TRS/D - 96.0KB	2

- [News Room](#)
- [Sales & Distribution](#)
- [About Us](#)
- [Investor Relations](#)
- [Employment](#)
- [Technical Documents](#)

- [Products](#)
- [Broadband Solution ICs](#)
- [Power Management](#)
- [Product Catalog](#)
- [New Products](#)
- [Competitor Cross Reference](#)
- [Applications Catalog](#)
- [Technical Documents](#)
- [CD/Document Ordering](#)
- [Models](#)
- [Reliability Data](#)
- [PCNs](#)
- [Samples FAQ](#)
- [Part Nomenclature](#)
- [Purchasing T's and C's](#)

- [Tech Support](#)
- [ON-Line Services](#)

[Print Page](#)

Device DTA143T

Bias Resistor Transistor

[Data Sheet](#) DTA114E/D - 106.0 (kb)

[Reference Manuals](#)

This new series of digital transistors is designed to replace a single device and its external resistor bias network. The BRT (Bias Resistor Transistor) contains a single transistor with a monolithic bias network consisting of two resistors; a series base resistor and a base-emitter resistor. The BRT eliminates these individual components by integrating them into a single device. The use of a BRT can reduce both system cost and board space. The device is housed in the TO-92 package which is designed for through hole applications.

Orderable Devices

Action	Device	Status	Package			Container		Budgetary Price/Unit
			Type	Pins	Case Outline	Type	Qty.	
Order Samples Buy Now	DTA143T	Active	TO-92 (TO-226)	3	29-11	Bulk	5,000	\$0.067
Order Samples	DTA143TRLRA	Active	TO-92 (TO-226)	3	29-11	Tape and Reel	2,000	\$0.067
Order Samples	DTA143TRLRM	Active	TO-92 (TO-226)	3	29-11	Tape and Ammunition Box	2,000	\$0.067
Order Samples	DTA143TRLRP	Active	TO-92 (TO-226)	3	29-11	Tape and Ammunition Box	2,000	\$0.067

Reference Manuals

Document Title	Document ID	Rev
Tape & Reel and Packaging Specifications for Small-Signal Transistors, FETs and Diodes	DL126TRS/D - 96.0KB	2

- News Room
- Sales & Distribution
- About Us
- Investor Relations
- Employment
- Technical Documents

- Products**
- [Broadband Solution ICs](#)
- [Power Management](#)
- [Product Catalog](#)
- [New Products](#)
- [Competitor Cross Reference](#)
- [Applications Catalog](#)
- [Technical Documents](#)
- [CD/Document Ordering](#)
- [Models](#)
- [Reliability Data](#)
- [PCNs](#)
- [Samples FAQ](#)
- [Part Nomenclature](#)
- [Purchasing T's and C's](#)

- Tech Support
- ON-Line Services

[Print Page](#)

Device DTA144E

Bias Resistor Transistor

[Data Sheet](#) DTA114E/D - 106.0 (kb)

[Models](#) | [Reference Manuals](#)

This new series of digital transistors is designed to replace a single device and its external resistor bias network. The BRT (Bias Resistor Transistor) contains a single transistor with a monolithic bias network consisting of two resistors; a series base resistor and a base-emitter resistor. The BRT eliminates these individual components by integrating them into a single device. The use of a BRT can reduce both system cost and board space. The device is housed in the TO-92 package which is designed for through hole applications.

Orderable Devices

Action	Device	Status	Package			Container		Budgetary Price/Unit
			Type	Pins	Case Outline	Type	Qty.	
Order Samples Buy Now	DTA144E	Active	TO-92 (TO-226)	3	29-11	Bulk	5,000	\$0.067
Order Samples	DTA144ERLRA	Active	TO-92 (TO-226)	3	29-11	Tape and Reel	2,000	\$0.067
Order Samples	DTA144ERLRM	Active	TO-92 (TO-226)	3	29-11	Tape and Ammunition Box	2,000	\$0.067
Order Samples	DTA144ERLRP	Active	TO-92 (TO-226)	3	29-11	Tape and Ammunition Box	2,000	\$0.067

Models

Document Title	Document ID	Rev
SP3 Model For DTA144ERLRA	DTA144ERLRA.SP3 - 1.0KB	0
SP2 Model For DTA144ERLRA	DTA144ERLRA.SP2 - 1.0KB	0
LIB Model For DTA144ERLRA	DTA144ERLRA.LIB - 1.0KB	0
SIN Model For DTA144ERLRA	DTA144ERLRA.SIN - 1.0KB	0

Reference Manuals

Document Title	Document ID	Rev
Tape & Reel and Packaging Specifications for Small-Signal Transistors, FETs and Diodes	DL126TRS/D - 96.0KB	2

