

Features

- Guard Ring Die Construction for Transient Protection
- Ideally Suited for Automatic Assembly
- Low Power Loss, High Efficiency
- Surge Overload Rating to 30A Peak
- For Use in Low Voltage, High Frequency Inverters, Free Wheeling, and Polarity Protection Application
- **Available in Lead Free Finish/RoHS Compliant Version (Note 3)**

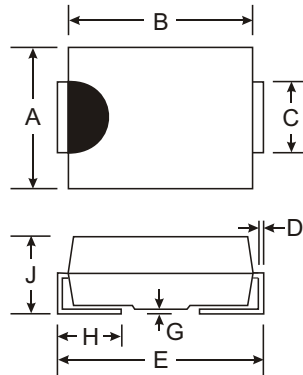

Dim	SMA		SMB	
	Min	Max	Min	Max
A	2.29	2.92	3.30	3.94
B	4.00	4.60	4.06	4.57
C	1.27	1.63	1.96	2.21
D	0.15	0.31	0.15	0.31
E	4.80	5.59	5.00	5.59
G	0.10	0.20	0.10	0.20
H	0.76	1.52	0.76	1.52
J	2.01	2.62	2.00	2.62
All Dimensions in mm				

Mechanical Data

- Case: SMA/SMB
- Case Material: Molded Plastic. UL Flammability Classification Rating 94V-0
- Moisture Sensitivity: Level 1 per J-STD-020C
- Terminals: Solder Plated Terminal - Solderable per MIL-STD-202, Method 208
- Also Available in Lead Free Plating (Matte Tin Finish). Please See Ordering Information, Note 5, on Page 3
- Polarity: Cathode Band or Cathode Notch
- Marking: Type Number
- Approximate Weight: SMA 0.064 grams
SMB 0.093 grams

No Suffix Designates SMA Package
"B" Suffix Designates SMB Package

Maximum Ratings and Electrical Characteristics @ T_A = 25°C unless otherwise specified

Single phase, half wave, 60Hz, resistive or inductive load.
For capacitive load, derate current by 20%.

Characteristic	Symbol	B120/B	B130/B	B140/B	B150/B	B160/B	Unit
Peak Repetitive Reverse Voltage	V _{RRM}	20	30	40	50	60	V
Working Peak Reverse Voltage	V _{RWM}						
DC Blocking Voltage	V _R						
RMS Reverse Voltage	V _{R(RMS)}	14	21	28	35	42	V
Average Rectified Output Current @ T _T = 130°C	I _O	1.0					A
Non-Repetitive Peak Forward Surge Current 8.3ms single half sine-wave superimposed on rated load	I _{FSM}	30					A
Forward Voltage @ I _F = 1.0A	V _{FM}	0.50			0.70		V
Peak Reverse Current @ T _A = 25°C at Rated DC Blocking Voltage @ T _A = 100°C	I _{RM}				0.5 10		mA
Typical Total Capacitance (Note 2)	C _T	110					pF
Typical Thermal Resistance Junction to Terminal (Note 1)	R _{θJT}	20					°C/W
Operating and Storage Temperature Range	T _J , T _{STG}	-65 to +150					°C

- Notes:
1. Thermal Resistance: Junction to terminal, unit mounted on PC board with 5.0 mm² (0.013 mm thick) copper pads as heat sink.
 2. Measured at 1.0 MHz and applied reverse voltage of 4.0V DC.
 3. RoHS revision 13.2.2003. Glass and High Temperature Solder Exemptions Applied, see EU Directive Annex Notes 5 and 7.

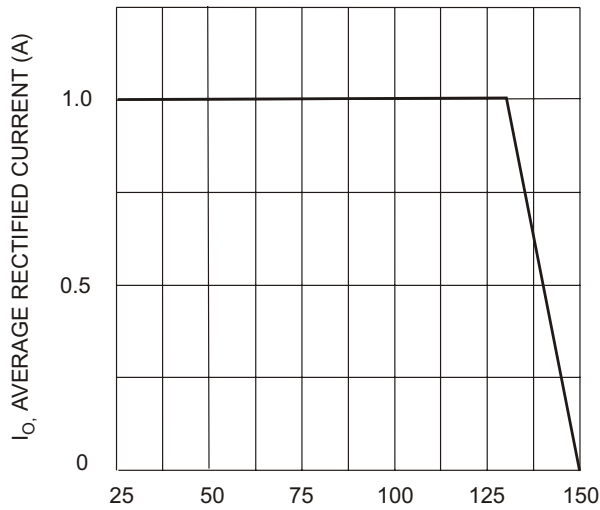

T_T , TERMINAL TEMPERATURE ($^{\circ}C$)
Fig. 1 Forward Current Derating Curve

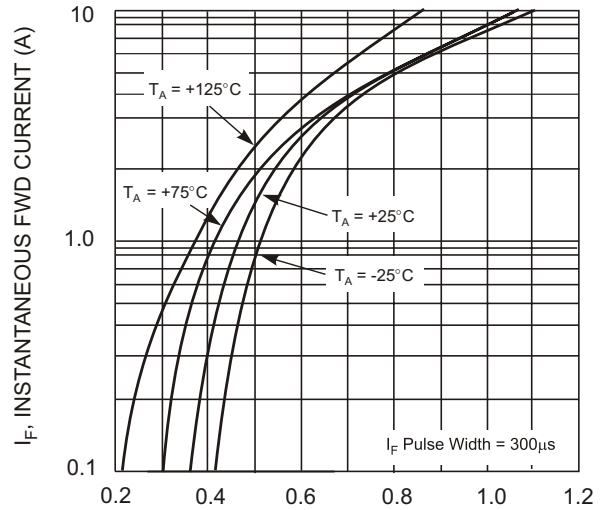

V_F , INSTANTANEOUS FORWARD VOLTAGE (V)
Fig. 2 Typical Forward Characteristics - B120/B thru B140/B

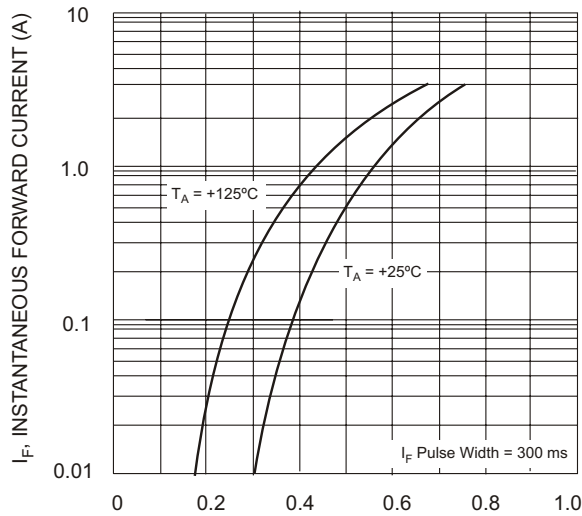

V_F , INSTANTANEOUS FWD VOLTAGE (V)
Fig. 3 Typ. Forward Characteristics - B150/B thru B160/B

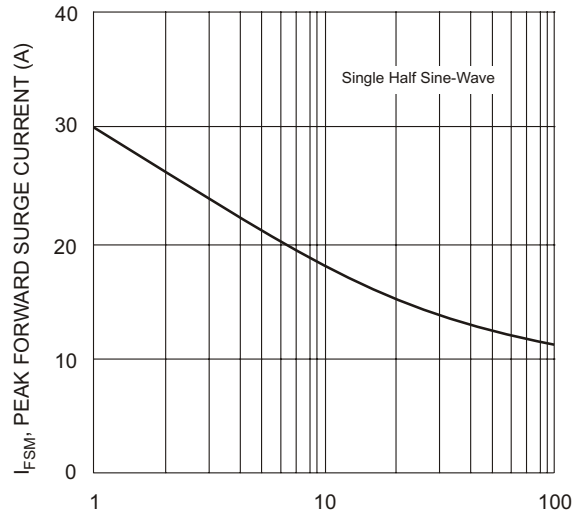
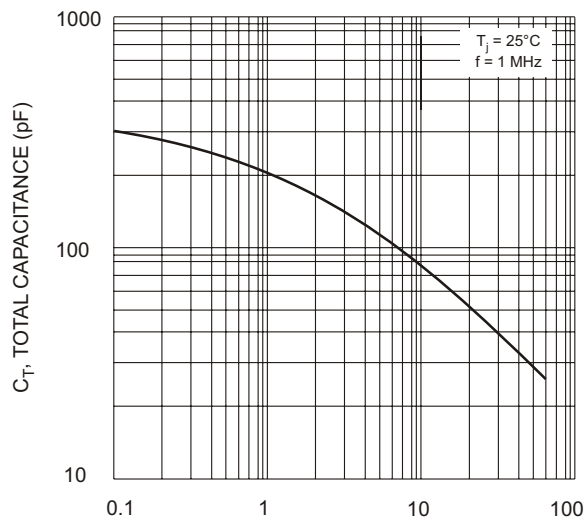
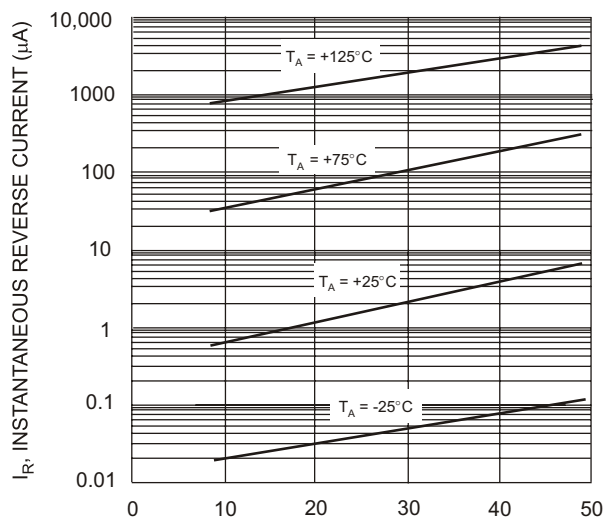

Fig. 4 Max Non-Repetitive Peak Fwd Surge Current



V_R , REVERSE VOLTAGE (V)
Fig. 5 Typical Total Capacitance



V_R , INSTANTANEOUS REVERSE VOLTAGE (V)
Fig. 6 Typical Reverse Characteristics, B120/B thru B140/B

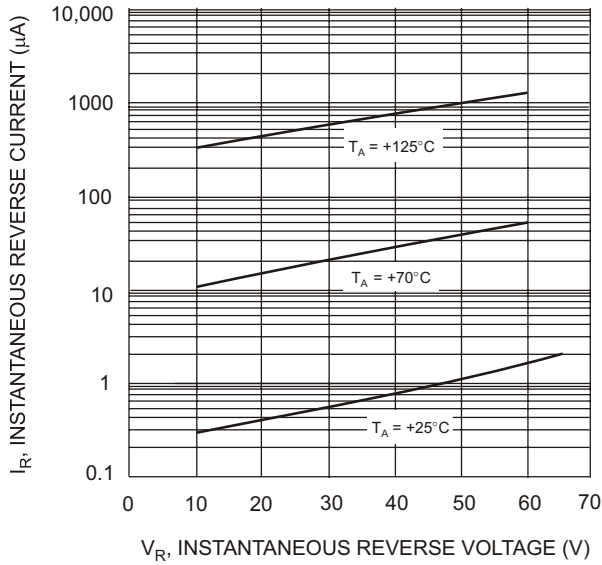

Fig. 7 Typical Reverse Characteristics, B150/B thru B160/B

Ordering Information (Note 4 & 5)

Device*	Packaging	Shipping
B1XX-13	SMA	5000/Tape & Reel
B1XXB-13	SMB	3000/Tape & Reel

- Notes:
- For Packaging Details, go to our website at <http://www.diodes.com/datasheets/ap02007.pdf>.
 - For Lead Free Finish/RoHS Compliant version part number, please add "-F" suffix to the part number above. Example: B120-13-F.

* xx = Device type, e.g. B120-13 (SMA package); B120B-13 (SMB package).

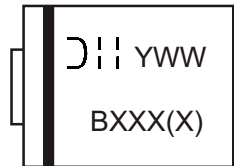

BXXX = Product type marking code, ex: B120 (SMA package)
 BXXXX = Product type marking code, ex: B160B (SMB package)
 D||| = Manufacturers' code marking
 YWW = Date code marking
 Y = Last digit of year ex: 2 for 2002
 WW = Week code 01 to 52

Note: Device has a cathode band (as shown above) and may also have a cathode notch (as shown on Page 1).