

## **PWM Control 2A Step-Down Converter**

### ❖ GENERAL DESCRIPTION

AX3113A consists of step-down switching regulator with PWM control. These device include a reference voltage source, oscillation circuit, error amplifier, internal PMOS and etc.

AX3113A provides low-ripple power, high efficiency, and excellent transient characteristics. The PWM control circuit is able to the duty ratio linearly form 0 up to 100%. An enable function, an over current protect function and short circuit protect function are built inside, and when OCP or SCP happens, the operation frequency will be reduced. Also, an internal compensation block is built in to minimum external component count.

With the addition of an internal P-channel Power MOS, a coil, capacitors, and a diode connected externally, these ICs can function as step-down switching regulators. They serve as ideal power supply units for portable devices when coupled with the SOP-8L package, providing such outstanding features as low current consumption. Since this converter can accommodate an input voltage up to 23V, it is also suitable for the operation via an AC adapter.

### ❖ FEATURES

- Input voltage : 4.5V to 23V
- Output voltage : 0.8V to  $V_{CC}$
- Duty ratio : 0% to 100% PWM control
- Oscillation frequency : 330KHz typ.
- Current Limit (CL), Enable function.
- Thermal Shutdown function.
- Short Circuit Protect (SCP).
- Built-in internal SW P-channel MOS.
- SOP-8L Pb-Free package.

❖ BLOCK DIAGRAM

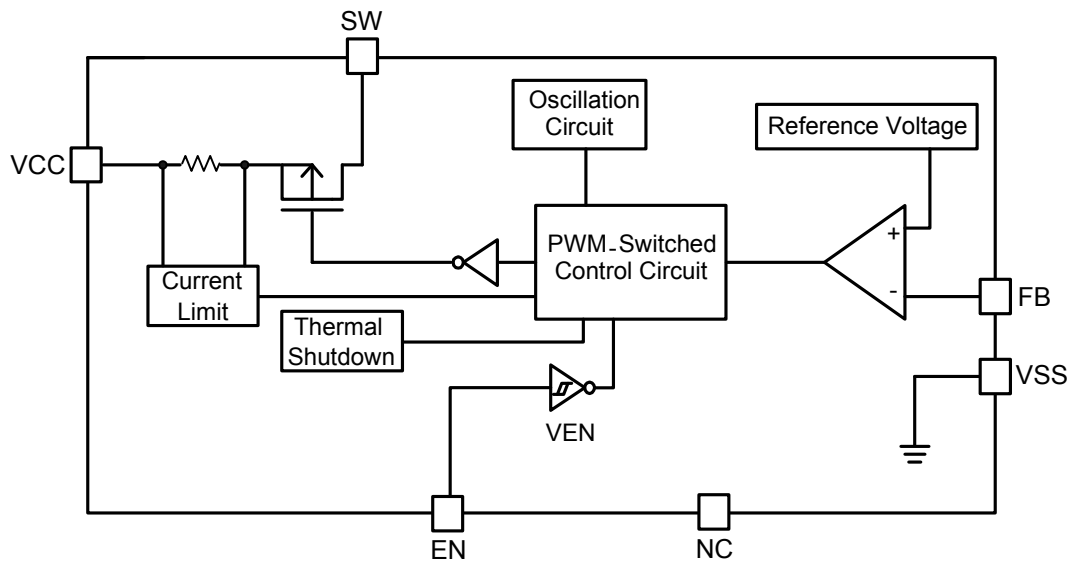

❖ PIN ASSIGNMENT

The package of AX3113A is SOP-8L; the pin assignment is given by:

( Top View )

**SOP-8L**

Name	Description
FB	Feedback pin
EN	Power-off pin H : normal operation(Step-down) L : Step-down operation stopped (All circuits deactivated)
NC	No Connect pin
VCC	IC power supply pin
SW	Switch pin. Connect external inductor and diode here.
V <sub>SS</sub>	GND pin

❖ ORDER/MARKING INFORMATION

Order Information	Top Marking
<p><b>AX3113A X X</b></p> <p>Package Type S: SOP-8L</p> <p>Packing Blank : Tube A : Taping</p>	<p>Logo ← <b>AX</b> 3 1 1 3 → Part number</p> <p>A Y Y W W X → ID code:internal</p> <p>AX3113A → WW: 01~52</p> <p>Year: 10=2010 11=2011</p>

**❖ ABSOLUTE MAXIMUM RATINGS** (at  $T_A = 25^\circ\text{C}$ )

Characteristics	Symbol	Rating	Unit
VCC Pin Voltage	$V_{CC}$	$V_{SS} - 0.3$ to $V_{SS} + 25$	V
Feedback Pin Voltage	$V_{FB}$	$V_{SS} - 0.3$ to $V_{CC}$	V
ON/OFF Pin Voltage	$V_{EN}$	$V_{SS} - 0.3$ to $V_{CC} + 0.3$	V
Switch Pin Voltage	$V_{SW}$	$V_{SS} - 0.3$ to $V_{CC} + 0.3$	V
Power Dissipation	PD	Internally limited	mW
Storage Temperature Range	$T_{ST}$	-40 to +150	$^\circ\text{C}$
Operating Junction Temperature Range	$T_J$	-20 to +125	$^\circ\text{C}$
Operating Supply Voltage	$V_{OP}$	4.5 to 23	V
Output Current	$I_{OUT}$	0 to 2	A
Thermal Resistance from Junction to case	$\theta_{JC}$	25	$^\circ\text{C}/\text{W}$
Thermal Resistance from Junction to ambient	$\theta_{JA}$	70	$^\circ\text{C}/\text{W}$

Note :  $\theta_{JA}$  is measured with the PCB copper area(need connect to SW pins) of approximately 1 in<sup>2</sup>(Multi-layer).

**❖ ESELECTRICAL CHARACTERISTICS**

( $V_{IN} = 12\text{V}$ ,  $V_{OUT}=3.3\text{V}$ ,  $T_A = 25^\circ\text{C}$ , unless otherwise specified)

Characteristics	Symbol	Conditions	Min	Typ	Max	Units
Feedback Voltage	$V_{FB}$	$I_{OUT}=0.1\text{A}$	0.784	0.800	0.816	V
Quiescent Current	$I_{CCQ}$	$V_{FB}=1.2\text{V}$ force driver off	-	3	5	mA
Feedback Bias Current	$I_{FB}$	$I_{OUT}=0.1\text{A}$	-	0.1	0.5	$\mu\text{A}$
Shutdown Supply Current	$I_{SD}$	$V_{EN}=0\text{V}$	-	2	10	$\mu\text{A}$
Current Limit	$I_{CL}$		2.5	-	-	A
Line Regulation	$\Delta V_{OUT}/V_{OUT}$	$V_{CC} = 8\text{V}\sim 23\text{V}$ , $I_{OUT}=0.2\text{A}$	-	1	2	%
Load Regulation	$\Delta V_{OUT}/V_{OUT}$	$I_{OUT} = 0.1$ to $2\text{A}$	-	0.2	0.5	%
Oscillation Frequency	$F_{OSC}$	SW pin	260	330	400	KHz
Switching Rising Time	$T_r$	$I_{OUT}=2\text{A}$	-	15	-	ns
Switching Falling Time	$T_f$	$I_{OUT}=2\text{A}$	-	15	-	ns
EN Pin Logic input threshold voltage	$V_{ENH}$	High (regulator ON)	2.0	-	-	V
	$V_{ENL}$	Low (regulator OFF)	-	-	0.8	
EN Pin Input Current	$I_{ENH}$	$V_{EN}=2.5\text{V}$ (ON)	-	20	-	$\mu\text{A}$
	$I_{ENL}$	$V_{EN}=0.3\text{V}$ (OFF)	-	-10	-	$\mu\text{A}$
Internal MOSFET $R_{DS(ON)}$	$R_{DS(ON)}$	$V_{CC}=12\text{V}$ , $V_{FB}=0\text{V}$	-	100	130	m $\Omega$
Efficiency	EFFI	$V_{CC} = 12\text{V}$ , $V_{OUT} = 5\text{V}$	$I_{OUT} = 1\text{A}$	-	92	%
			$I_{OUT} = 2\text{A}$	-	91	

❖ APPLICATION CIRCUIT

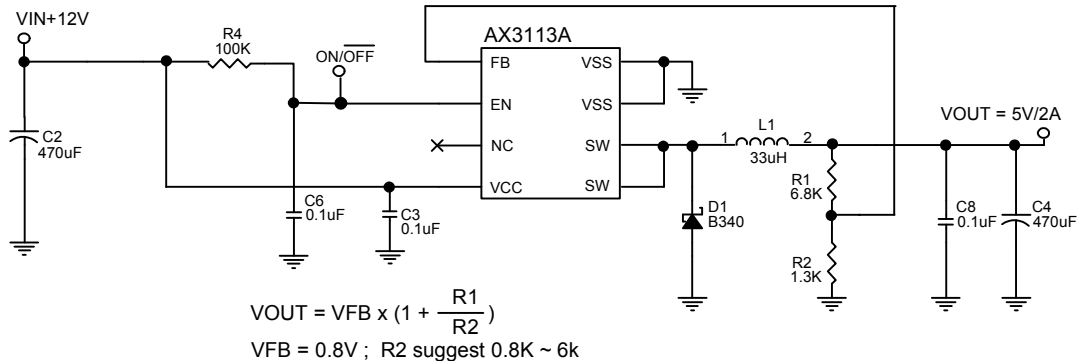

❖ FUNCTION DESCRIPTIONS

**PWM Control**

The AX3113A consists of DC/DC converters that employ a pulse-width modulation (PWM) system. In converters of the AX3113A, the pulse width varies in a range from 0 to 100%, according to the load current. The ripple voltage produced by the switching can easily be removed through a filter because the switching frequency remains constant. Therefore, these converters provide a low-ripple power over broad ranges of input voltage and load current.

**Setting the Output Voltage**

Application circuit item shows the basic application circuit with adjustable output version. The external resistor sets the output voltage according to the following equation:

$$V_{OUT} = 0.8V \times \left(1 + \frac{R1}{R2}\right)$$

Table 1 Resistor select for output voltage setting

V <sub>OUT</sub>	R2	R1
5V	1.3K	6.8K
3.3V	1.5K	4.7K
2.5V	2.2K	4.7K
1.8V	2K	2.5K
1.5V	2.2K	2.0K
1.2V	3K	1.5K
1.0V	3K	0.75K

❖ TYPICAL CHARACTERISTICS

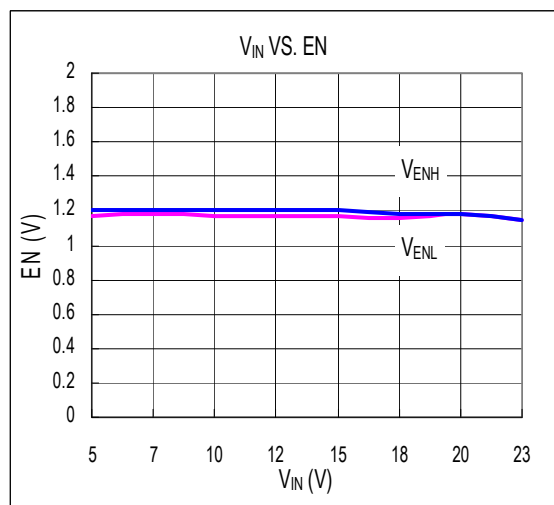
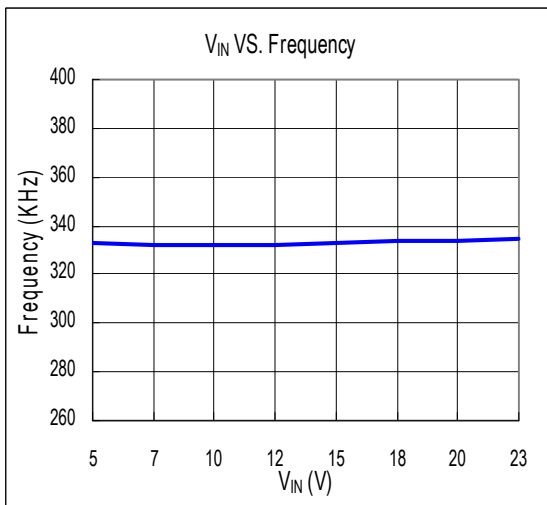
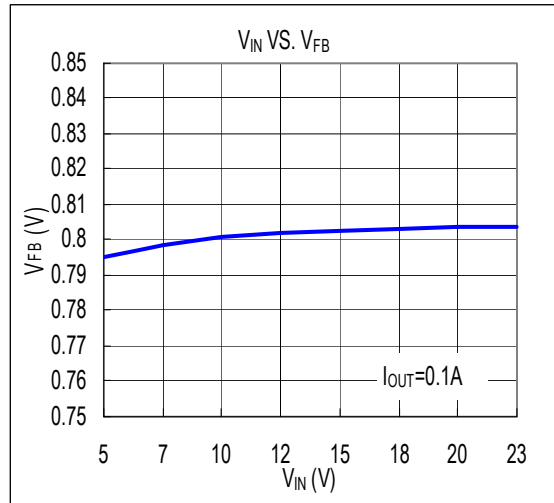
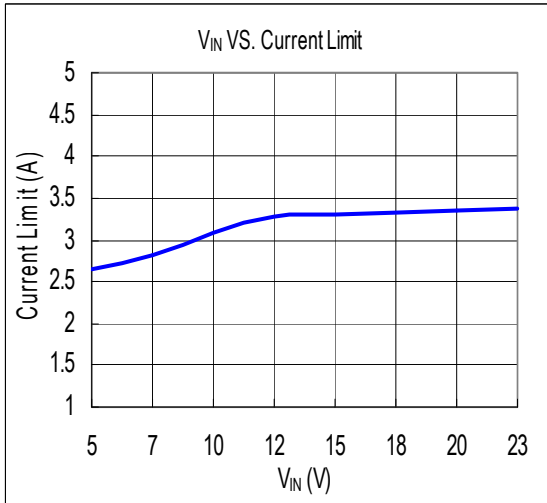
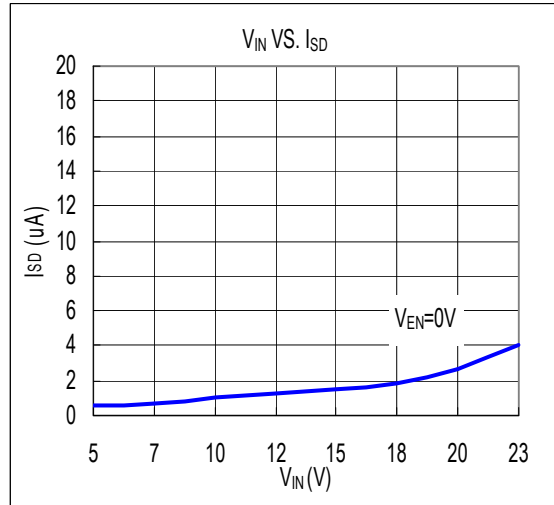
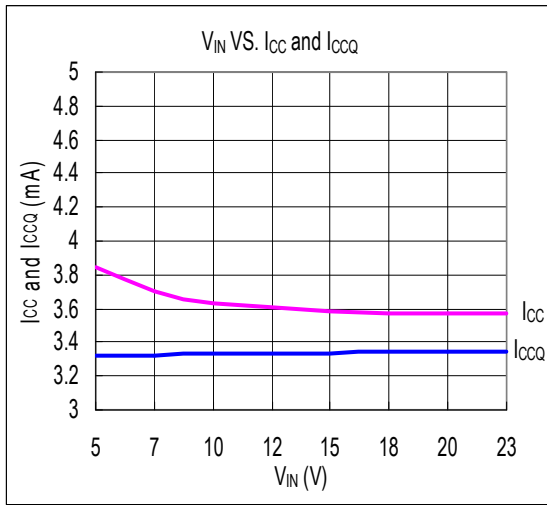

❖ TYPICAL CHARACTERISTICS (CONTINUES)

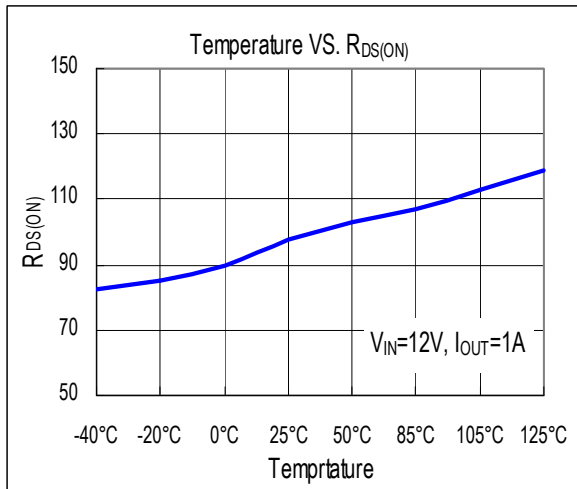
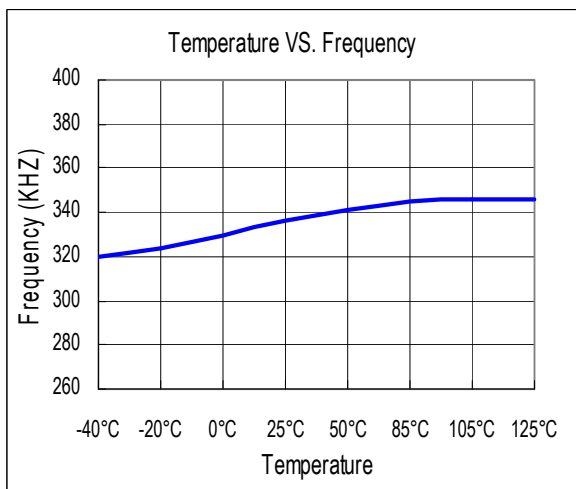
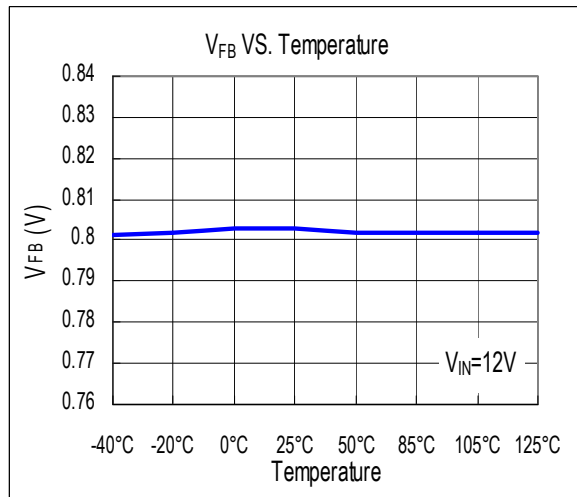
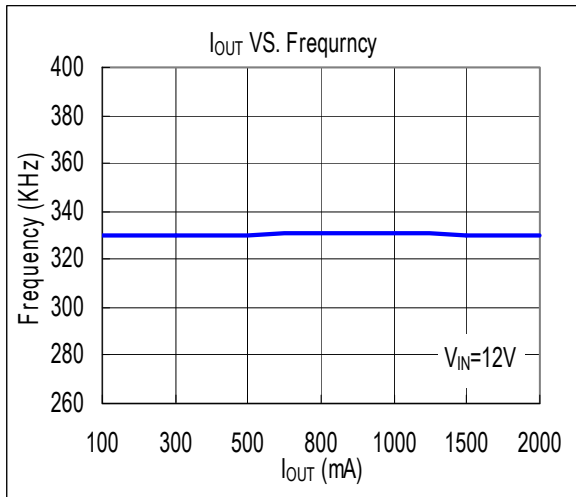
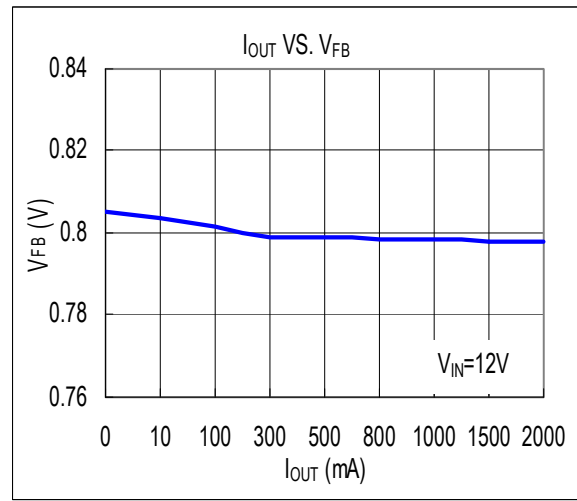
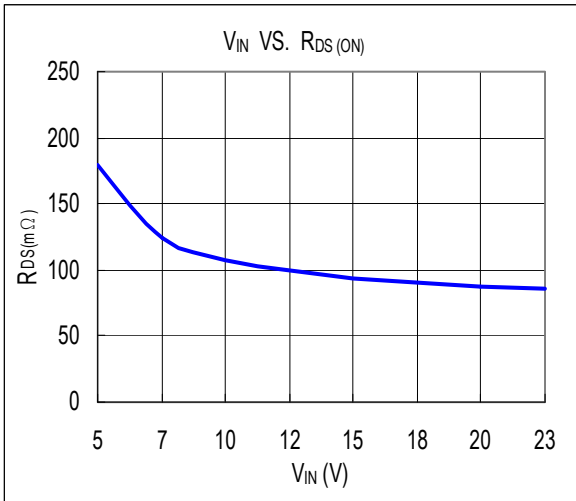

❖ TYPICAL CHARACTERISTICS (CONTINUES)

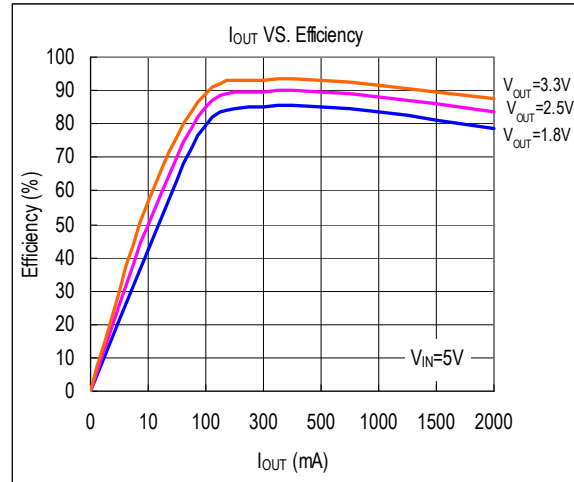
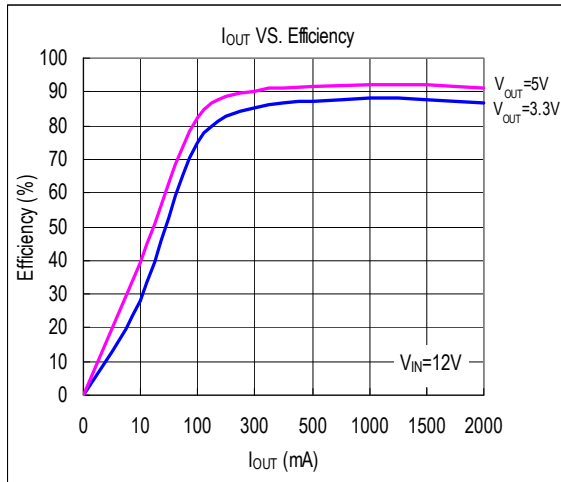

❖ PACKAGE OUTLINES

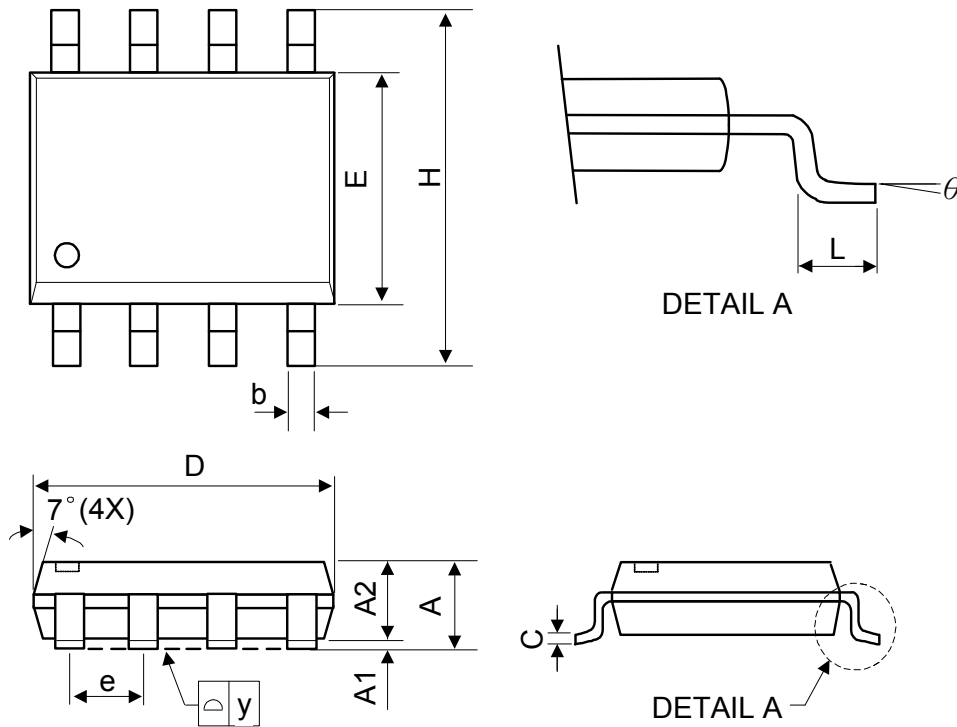

Symbol	Dimensions in Millimeters			Dimensions in Inches		
	Min.	Nom.	Max.	Min.	Nom.	Max.
A	-	-	1.75	-	-	0.069
A1	0.1	-	0.25	0.04	-	0.1
A2	1.25	-	-	0.049	-	-
C	0.1	0.2	0.25	0.0075	0.008	0.01
D	4.7	4.9	5.1	0.185	0.193	0.2
E	3.7	3.9	4.1	0.146	0.154	0.161
H	5.8	6	6.2	0.228	0.236	0.244
L	0.4	-	1.27	0.015	-	0.05
b	0.31	0.41	0.51	0.012	0.016	0.02
e	1.27 BSC			0.050 BSC		
y	-	-	0.1	-	-	0.004
θ	0°	-	8°	0°	-	8°

Mold flash shall not exceed 0.25mm per side

JEDEC outline: MS-012 AA