

### Applications

- Wireless Infrastructure
- CATV / SATV / MoCA
- Point to Point
- Defense & Aerospace
- Test & Measurement Equipment
- General Purpose Wireless

### Product Features

- DC – 6000 MHz
- Flat, broadband frequency response
- 15.3 dB Gain at 1900 MHz
- 3.6 dB Noise Figure at 1900 MHz
- +29 dBm Output IP3 at 1900 MHz
- +14.4 dBm P1dB at 1900 MHz
- 50 Ohm Cascadable Gain Block
- Single Supply, 45 mA Current
- SOT-363 Package

### General Description

The TQP369181 is a general-purpose buffer amplifier that offers high dynamic range in a low-cost surface-mount package. At 1900 MHz, the amplifier typically provides 15.3 dB gain, +29 dBm OIP3, and 3.6 dB Noise Figure while drawing 45 mA current. The device combines dependable performance with consistent quality to maintain MTTF values exceeding 100 years at mounting temperatures of +85 °C. The device is housed in a lead-free/green/RoHS-compliant industry-standard SOT-363 package.

The TQP369181 consists of a Darlington-pair amplifier using the high reliability InGaP/GaAs HBT process technology. Only DC-blocking capacitors, a bias resistor, and an inductive RF choke are required for operation.

This broadband MMIC amplifier can be directly applied to various current and next generation wireless technologies such as CDMA, W-CDMA, and LTE. In addition, the TQP369181 will work for other applications within the DC to 6 GHz frequency range.



SOT-363 Package

### Functional Block Diagram

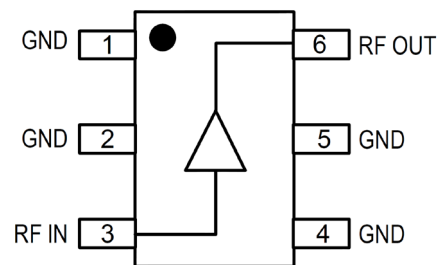

### Pin Configuration

Pin No.	Label
3	RF IN
6	RF OUT
1, 2, 4, 5	GND

### Ordering Information

Part No.	Description
TQP369181	InGaP/GaAs HBT Gain Block
TQP369181-PCB	500 – 6000 MHz Evaluation Board

Standard T/R size = 3000 pieces on a 7" reel

### Absolute Maximum Ratings

Parameter	Rating
Storage Temperature	-55 to 150 °C
RF Input Power, CW, 50Ω, T=25 °C	+27 dBm
Device Voltage (V <sub>CC</sub> )	+5.2 V

Operation of this device outside the parameter ranges given above may cause permanent damage.

### Recommended Operating Conditions

Parameter	Min	Typ	Max	Units
T <sub>CASE</sub>	-40		+85	°C
T <sub>j</sub> for >10 <sup>6</sup> hours MTTF			+160	°C

Electrical specifications are measured at specified test conditions. Specifications are not guaranteed over all recommended operating conditions.

### Electrical Specifications

Test conditions unless otherwise noted: I<sub>CC</sub> =45 mA, T<sub>CASE</sub>= +25 °C, 50Ω system

Parameter	Conditions	Min	Typ	Max	Units
Operational Frequency Range		DC		6000	MHz
Test Frequency			1900		MHz
Gain		13.8	15.3	16.8	dB
Input Return Loss			30		dB
Output Return Loss			24		dB
Output P1dB			+14.6		dBm
Output IP3	P <sub>out</sub> =0 dBm/tone, Δf= 1 MHz	+26.0	+29.0		dBm
Noise Figure			3.6		dB
Device Voltage (V <sub>CC</sub> )		3.0	3.9	4.5	V
Device Current (I <sub>CC</sub> )			45		mA
Thermal Resistance (θ <sub>jc</sub> )	Junction to case <sup>(1)</sup>			226	°C/W

Notes:

1. Thermal path is from the device junction through the package ground tab (pins 2,4) to the backside mounting surface.

### S-Parameters

Test Conditions:  $V_{CC}=+3.9$  V (typ.),  $I_{CC}=45$  mA (typ.),  $T_{CASE}=+25$  °C, 50  $\Omega$  system, calibrated to device leads

Freq (MHz)	S11 (dB)	S11 (ang)	S21 (dB)	S21 (ang)	S12 (dB)	S12 (ang)	S22 (dB)	S22 (ang)
10	-36.7	-179.3	15.9	179.7	-18.8	0.3	-30.2	14.8
20	-35.9	178.4	15.9	179.3	-18.8	-0.1	-30.0	5.6
50	-34.6	171.4	15.9	178.5	-18.8	-0.3	-30.8	0.4
100	-34.1	164.0	15.9	177.2	-18.8	-0.7	-31.2	-5.2
200	-32.6	153.3	15.9	174.6	-18.9	-0.9	-30.7	-10.9
500	-30.6	137.1	15.8	167.0	-18.9	-2.6	-32.3	-16.0
900	-29.1	115.5	15.6	157.3	-19.0	-3.8	-33.1	-59.1
1000	-29.1	118.6	15.6	154.9	-19.0	-4.1	-32.0	-59.5
1500	-27.9	74.3	15.3	143.1	-19.1	-6.1	-28.2	-75.7
1900	-26.7	28.5	15.1	133.6	-19.4	-7.5	-22.9	-63.3
2000	-24.9	17.8	15.0	131.3	-19.4	-8.0	-21.7	-64.4
2500	-18.2	-18.4	14.6	120.4	-19.7	-9.8	-16.6	-62.9
3000	-14.4	-24.2	14.2	110.1	-20.2	-11.3	-14.0	-57.5
3500	-13.1	-26.3	13.8	100.4	-20.5	-13.1	-12.9	-54.0
4000	-13.1	-26.2	13.5	91.2	-20.8	-12.4	-13.7	-50.2
4500	-15.0	-20.5	13.3	81.7	-21.2	-14.4	-16.5	-41.9
5000	-19.1	0.7	13.1	71.2	-21.7	-15.9	-24.0	0.6
5500	-20.6	60.7	12.9	60.7	-22.4	-17.4	-18.9	84.1
6000	-17.1	100.0	12.6	48.8	-23.2	-18.4	-13.5	105.3

Notes:

1. Measured on TQP369181-PCB with L1 removed and C2, C3 replaced with 0 $\Omega$  resistors.
2. Bias applied to device output via internal network analyzer wide-band bias tee.
3. SOLT Ecal at network analyzer test cable ends.
4. Input and output reference planes extended to the device leads.

### TQP369181-PCB Evaluation Board

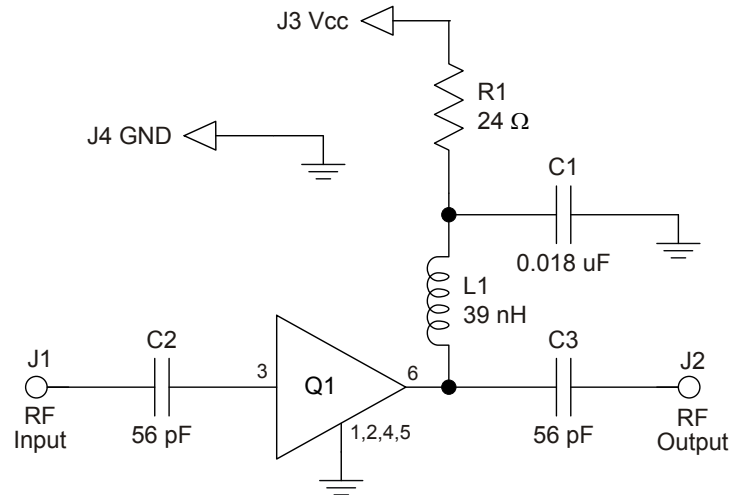
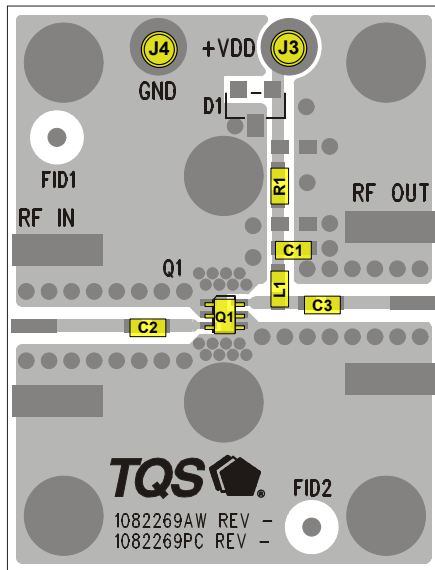

**Notes:**

1. See Evaluation Board PCB Information section for material and stack-up.
2. All components are of 0603 size unless otherwise stated.

### Bill of Material – TQP369181-PCB

Reference Des.	Value	Description	Manuf.	Part Number
Q1	n/a	High Linearity LNA Gain Block	TriQuint	TQP369181
C1	0.018 uF	Cap, Chip, 0603, 16V, X7R, 10%	various	
C2, C3	56 pF	Cap, Chip, 0603, 50V, NPO, 5%	various	
L1	39 nH	Inductor, 0603, 5%, CS Series	Coilcraft	0603CS-39NXJL
R1	24 Ω	Res, Chip, 0805, 1/10W, 5%	various	

### Component Values for Specific Frequencies

Frequency (MHz)	50	500	900	1900	2200	2500	3500
L1	820 nH	220 nH	68 nH	27 nH	22 nH	18 nH	15 nH
C2, C3	.018 uF	1000 pF	100 pF	68 pF	68 pF	56 pF	39 pF

### Bias Resistor Values for Various Supply Voltages

V <sub>SUPPLY</sub> (V)	5	6	7	8	9	10	12
R1	24 Ω	47 Ω	68 Ω	91 Ω	110 Ω	130 Ω	180 Ω
Component Size	0805	1206	1210	1210	1210	2010	2010

### Typical Performance – TQP369181-PCB

Test conditions unless otherwise noted:  $V_{SUPPLY} = +5\text{ V}$ ,  $R_1 = 24\ \Omega$ ,  $I_{CC} = 45\text{ mA}$ ,  $T_{CASE} = +25^\circ\text{C}$

Parameter	Typical Value									Units
Frequency	500	900	1900	2100	2600	3500	4000	5000	6000	MHz
Gain	15.6	15.6	15.3	15.0	14.7	13.8	13.5	13.1	12.6	dB
Input Return Loss	17	26	30	24	17	13	13	19	17	dB
Output Return Loss	16	24	24	20	16	13	14	24	14	dB
Output P1dB	+15.4	+15.2	+14.6	+14.3	+14.4	+13.9	+13.0	+12.1	+8.8	dBm
OIP3	+30.6	+30.0	+29.0	+28.5	+27.7	+26.3	+25.3	+22.0	+22.2	dBm
Noise Figure	3.6	3.6	3.6	3.6	3.7	4.0	4.0	4.0	4.4	dB

Notes:

- OIP3 measured with two tones at an output power of 0 dBm / tone separated by 1 MHz.

### Performance Plots – TQP369181-PCB

Test conditions unless otherwise noted:  $V_{SUPPLY} = +5\text{ V}$ ,  $R_1 = 24\ \Omega$ ,  $I_{CC} = 45\text{ mA}$ ,  $T_{CASE} = +25^\circ\text{C}$

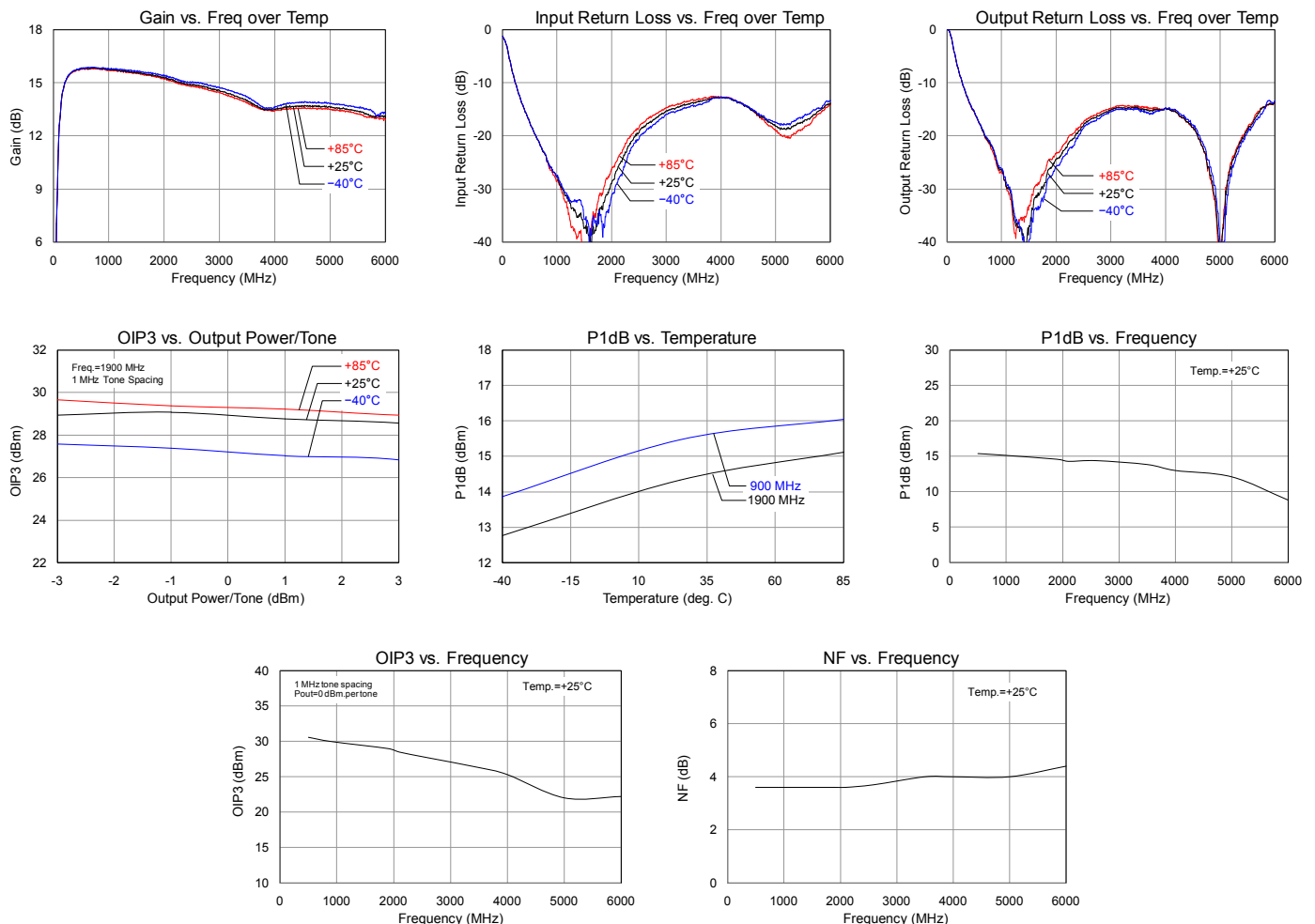

## Pin Configuration and Description

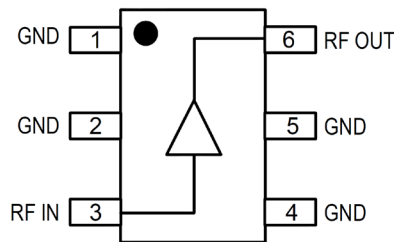

Pin No.	Label	Description
3	RF IN	RF input, matched to 50 Ohms. External DC Block is required.
6	RF OUT	RF output / DC supply, matched to 50 Ohms. External DC
1, 2, 4, 5	GND	RF/DC ground. Use recommended via pattern to minimize inductance and thermal resistance. See PCB Mounting Pattern for suggested footprint.

## Evaluation Board PCB Information

TriQuint PCB 1082269 Material and Stack-up

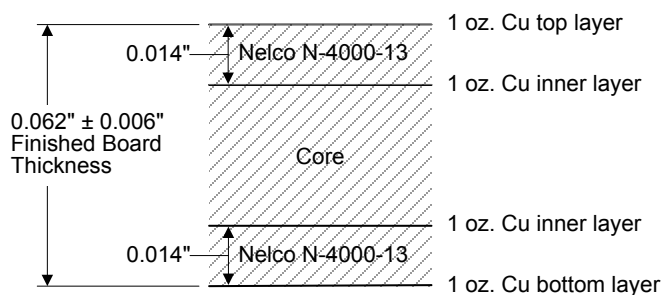

50 Ohm Line Dimensions: Width=0.029"  
Spacing=0.035"

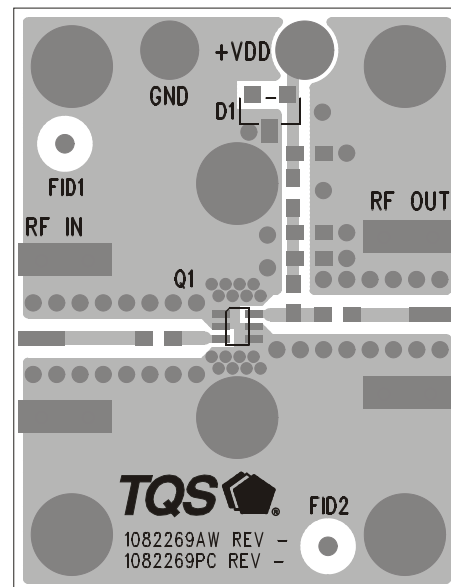

### Package Marking and Dimensions

The top surface of the package is marked with a "181" designator and the bottom surface is marked with an alphanumeric lot code.

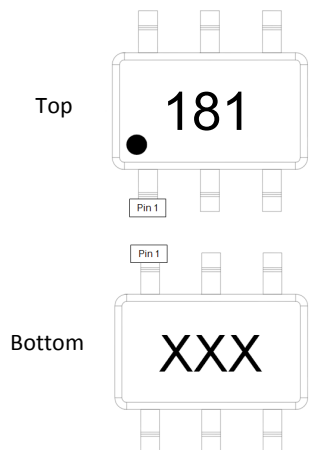

SYMBOL	MIN	MAX
A	-	1.10 (0.043)
A1	0	0.10 (0.004)
A2	0.70 (0.028)	1.00 (0.039)
D	2.00 (0.079) BASIC	
E	2.10 (0.083) BASIC	
E1	1.25 (0.049) BASIC	
L	0.21 (0.008)	0.41 (0.016)
L1	0.42 (0.017) REF	
L2	0.15 (0.006) BASIC	
?	0'8	8'8
?1	4'8	12'8
b	0.15 (0.006)	0.30 (0.012)
c	0.08 (0.003)	0.22 (0.009)
e	0.65 (0.026) BASIC	
e1	1.30 (0.051) BASIC	

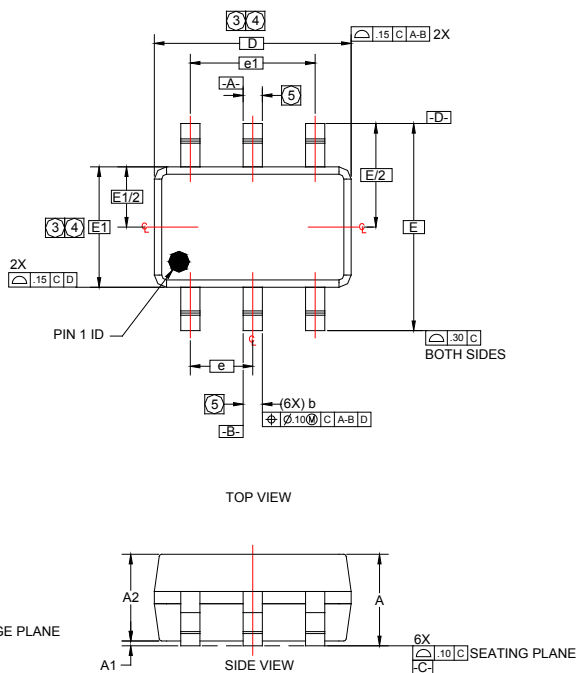

**Notes:**

1. Dimensions are in millimeters (Inches)
2. Dimensions and tolerances per ASME Y14.5M-1194. Package conforms to JEDEC MO-203, Issue B.

### PCB Mounting Pattern

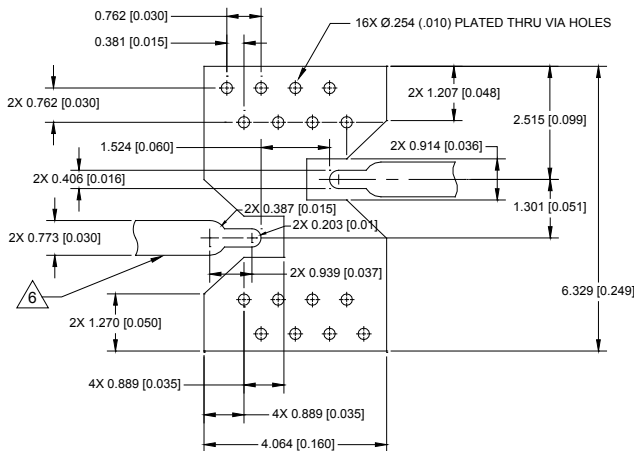

**Notes:**

1. All dimensions are in millimeters(inches). Angles are in degrees.
2. Use 1 oz. copper minimum for top and bottom layer metal.
3. Vias are required under the backside paddle of this device for proper RF/DC grounding and thermal dissipation.
4. Do not remove or minimize via hole structure in the PCB. Thermal and RF grounding is critical.
5. We recommend a 0.35mm (#80/.0135") diameter bit for drilling via holes and a final plated thru diameter of 0.25 mm (0.10").
6. The RF I/O trace transition shown is to a 30 mil wide line. Modify transition as required to interface with other line widths.

## Product Compliance Information

### ESD Sensitivity Ratings



Caution! ESD-Sensitive Device

ESD Rating: Class 1C  
Value:  $\geq 1000$  V and  $< 2000$  V  
Test: Human Body Model (HBM)  
Standard: JEDEC Standard JS-001-2012

ESD Rating: Class C3  
Value:  $\geq 1000$  V  
Test: Charged Device Model (CDM)  
Standard: JEDEC Standard JESD22-C101F

### MSL Rating

MSL Rating: Level 1  
Test: 260°C convection reflow  
Standard: JEDEC Standard IPC/JEDEC J-STD-020

### Solderability

Compatible with both lead-free (260 °C maximum reflow temperature) and tin/lead (245 °C maximum reflow temperature) soldering processes.

Contact plating: NiPdAu

### RoHs Compliance

This part is compliant with EU 2002/95/EC RoHS directive (Restrictions on the Use of Certain Hazardous Substances in Electrical and Electronic Equipment).

This product also has the following attributes:

- Lead Free
- Halogen Free (Chlorine, Bromine)
- Antimony Free
- TBBP-A (C<sub>15</sub>H<sub>12</sub>Br<sub>4</sub>O<sub>2</sub>) Free
- PFOS Free
- SVHC Free

## Contact Information

For the latest specifications, additional product information, worldwide sales and distribution locations, and information about TriQuint:

**Web:** [www.triquint.com](http://www.triquint.com)      **Tel:** +1.503.615.9000  
**Email:** [info-sales@triquint.com](mailto:info-sales@triquint.com)      **Fax:** +1.503.615.8902

For technical questions and application information:

**Email:** [sjapplications.engineering@triquint.com](mailto:sjapplications.engineering@triquint.com)

## Important Notice

The information contained herein is believed to be reliable. TriQuint makes no warranties regarding the information contained herein. TriQuint assumes no responsibility or liability whatsoever for any of the information contained herein. TriQuint assumes no responsibility or liability whatsoever for the use of the information contained herein. The information contained herein is provided "AS IS, WHERE IS" and with all faults, and the entire risk associated with such information is entirely with the user. All information contained herein is subject to change without notice. Customers should obtain and verify the latest relevant information before placing orders for TriQuint products. The information contained herein or any use of such information does not grant, explicitly or implicitly, to any party any patent rights, licenses, or any other intellectual property rights, whether with regard to such information itself or anything described by such information.

TriQuint products are not warranted or authorized for use as critical components in medical, life-saving, or life-sustaining applications, or other applications where a failure would reasonably be expected to cause severe personal injury or death.