

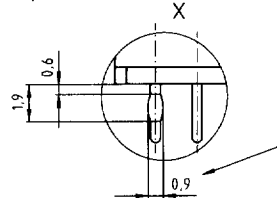

UL-recognized component, E 96569

**Serie MKS 19070, Stiftwanne stehend**  
**Series MKS 19070, Pin connector for vertical connections**

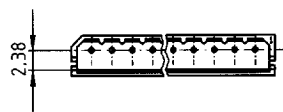
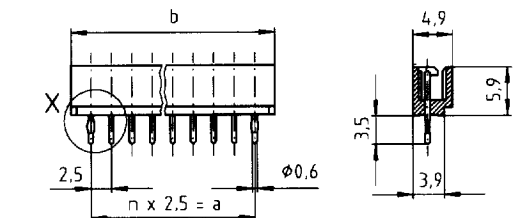
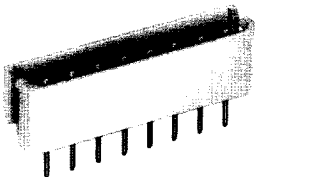

Jeweils erster und letzter Stift.  
Nur bei der Ausführung MKS ... - 6 - 1 ...  
Only first and last pin.  
Only version MKS ... - 6 - 1 ...

Polzahl Positions	Artikel-Nummer Part number	Abmessungen A Dimensions A	Abmessungen B Dimensions B
2	MKS 19072 - 6 - * - 202	2,5	7,4
3	MKS 19073 - 6 - * - 303	5,0	9,9
4	MKS 19074 - 6 - * - 404	7,5	12,4
5	MKS 19075 - 6 - * - 505	10,0	14,9
6	MKS 19076 - 6 - * - 606	12,5	17,4
7	MKS 19077 - 6 - * - 707	15,0	19,9
8	MKS 19078 - 6 - * - 808	17,5	22,4
9	MKS 19079 - 6 - * - 909	20,0	24,9
10	MKS 19080 - 6 - * - 1010	22,5	27,4
11	MKS 19081 - 6 - * - 1111	25,0	29,9
12	MKS 19082 - 6 - * - 1212	27,5	32,4
13	MKS 19083 - 6 - * - 1313	30,0	34,9
14	MKS 19084 - 6 - * - 1414	32,5	37,4
15	MKS 19085 - 6 - * - 1515	35,0	39,9
16	MKS 19086 - 6 - * - 1616	37,5	42,4
17	MKS 19087 - 6 - * - 1717	40,0	44,9
18	MKS 19088 - 6 - * - 1818	42,5	47,4
19	MKS 19089 - 6 - * - 1919	45,0	49,9
20	MKS 19090 - 6 - * - 2020	47,5	52,4



UL-recognized component, E 96569

**Serie MKS 19090, Stiftwanne liegend**  
**Series MKS 19090, Pin connector for horizontal connections**

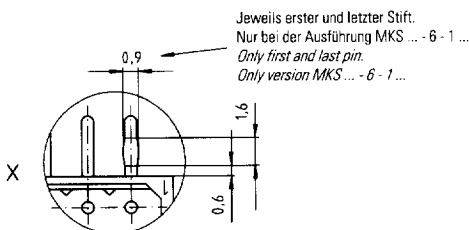
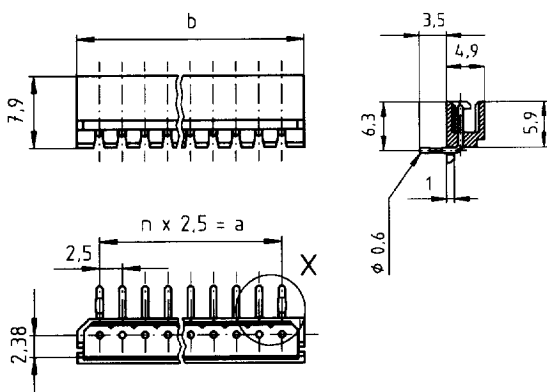
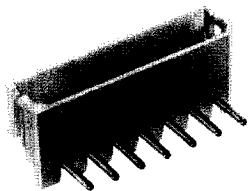

Jeweils erster und letzter Stift.  
Nur bei der Ausführung MKS ... - 6 - 1 ...  
Only first and last pin.  
Only version MKS ... - 6 - 1 ...

Polzahl Positions	Artikel-Nummer Part number	Abmessungen A Dimensions A	Abmessungen B Dimensions B
2	MKS 19092 - 6 - * - 202	2,5	7,4
3	MKS 19093 - 6 - * - 303	5,0	9,9
4	MKS 19094 - 6 - * - 404	7,5	12,4
5	MKS 19095 - 6 - * - 505	10,0	14,9
6	MKS 19096 - 6 - * - 606	12,5	17,4
7	MKS 19097 - 6 - * - 707	15,0	19,9
8	MKS 19098 - 6 - * - 808	17,5	22,4
9	MKS 19099 - 6 - * - 909	20,0	24,9
10	MKS 19100 - 6 - * - 1010	22,5	27,4
11	MKS 19101 - 6 - * - 1111	25,0	29,9
12	MKS 19102 - 6 - * - 1212	27,5	32,4
13	MKS 19103 - 6 - * - 1313	30,0	34,9
14	MKS 19104 - 6 - * - 1414	32,5	37,4
15	MKS 19105 - 6 - * - 1515	35,0	39,9
16	MKS 19106 - 6 - * - 1616	37,5	42,4
17	MKS 19107 - 6 - * - 1717	40,0	44,9
18	MKS 19108 - 6 - * - 1818	42,5	47,4
19	MKS 19109 - 6 - * - 1919	45,0	49,9
20	MKS 19110 - 6 - * - 2020	47,5	52,4

\* Bitte fügen Sie hier die **Kennziffer** für die Stiftversion gemäß folgender Tabelle ein.  
\* Please enter here the **code number** for the pin version as indicated in the chart below.

Stiftversion Pin version	Kennziffer Code number
Stift Ø 0,6 mm Pin Ø 0.6 mm	0
Stift Ø 0,6 mm mit Sicke im Einlötbereich Pin Ø 0.6 mm with kinked solder area	1