

**CQY80X, CQY80NX
CQY80, CQY80N**



**OPTICALLY COUPLED
ISOLATOR
PHOTOTRANSISTOR OUTPUT**

APPROVALS

- UL recognised, File No. E91231
- **'X' SPECIFICATION APPROVALS**
- CQY80X is VDE 0884 in 3 available lead forms :-
 - STD
 - G form
 - SMD approved to CECC 00802
- CQY80NX - VDE 0884 pending
- CQY80X is certified to EN60950 by the following Test Bodies :-
 - Nemko - Certificate No. P96101299
 - Fimko - Registration No. 190469-01..22
 - Semko - Reference No. 9620076 01
 - Demko - Reference No. 305567
 - CQY80NX - EN60950 pending

DESCRIPTION

The CQY80 series of optically coupled isolators consist of infrared light emitting diode and NPN silicon photo transistor in a standard 6 pin dual in line plastic package.

FEATURES

- Options :-
 - 10mm lead spread - add G after part no.
 - Surface mount - add SM after part no.
 - Tape&reel - add SMT&R after part no.
- High Isolation Voltage (5.3kV_{RMS}, 7.5kV_{PK})
- Custom electrical selections available

APPLICATIONS

- DC motor controllers
- Industrial systems controllers
- Signal transmission between systems of different potentials and impedances

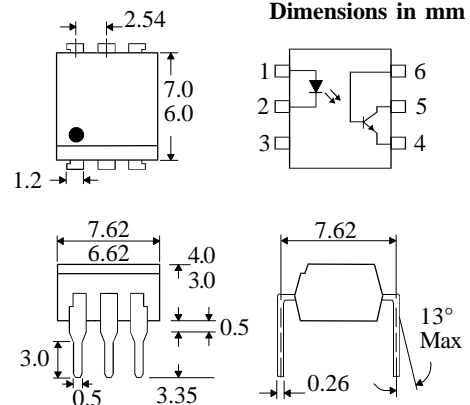
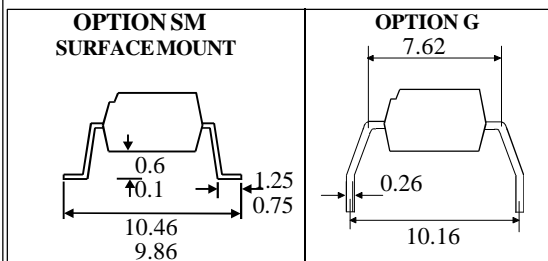

**ABSOLUTE MAXIMUM RATINGS
(25°C unless otherwise specified)**

Storage Temperature _____ -55°C to + 150°C
 Operating Temperature _____ -55°C to + 100°C
 Lead Soldering Temperature
 (1/16 inch (1.6mm) from case for 10 secs) 260°C

INPUT DIODE

Forward Current _____ 60mA
 Reverse Voltage _____ 6V
 Power Dissipation _____ 105mW

OUTPUT TRANSISTOR

Collector-emitter Voltage BV_{CEO} _____ 32V
 Collector-base Voltage BV_{CBO} _____ 70V
 Emitter-collector Voltage BV_{ECO} _____ 6V
 Power Dissipation _____ 160mW

POWER DISSIPATION

Total Power Dissipation _____ 200mW
 (derate linearly 2.67mW/°C above 25°C)

ISOCOM COMPONENTS LTD
 Unit 25B, Park View Road West,
 Park View Industrial Estate, Brenda Road
 Hartlepool, Cleveland, TS25 1YD
 Tel: (01429) 863609 Fax :(01429) 863581



ELECTRICAL CHARACTERISTICS ($T_A = 25^\circ\text{C}$ Unless otherwise noted)

PARAMETER		MIN	TYP	MAX	UNITS	TEST CONDITION
Input	Forward Voltage (V_F)		1.2	1.60	V	$I_F = 50\text{mA}$ $I_R = 10\mu\text{A}$ $V_R = 6\text{V}$
	Reverse Voltage (V_R)	6			V	
	Reverse Current (I_R)			10	μA	
Output	Collector-emitter Breakdown (BV_{CEO}) (Note 2)	32			V	$I_C = 1\text{mA}$ $I_E = 100\mu\text{A}$ $V_{CE} = 20\text{V}$
	Emitter-collector Breakdown (BV_{ECO})	6			V	
	Collector-emitter Dark Current (I_{CEO})			200	nA	
Coupled	I_C / I_F (CTR) (Note 2)	0.5				$10\text{mA } I_F, 5\text{V } V_{CE}$
	Current Transfer Ratio (CTR) (Note 2)	50			%	$10\text{mA } I_F, 5\text{V } V_{CE}$
	Collector-emitter Saturation Voltage $V_{CE(SAT)}$			0.3	V	$10\text{mA } I_F, 1\text{mA } I_C$
	Input to Output Isolation Voltage V_{ISO}	5300 7500			V_{RMS} V_{PK}	See note 1 See note 1
	Input-output Isolation Resistance R_{ISO}	5×10^{10}			Ω	$V_{IO} = 500\text{V}$ (note 1)

Note 1 Measured with input leads shorted together and output leads shorted together.

Note 2 Special Selections are available on request. Please consult the factory.

Type	$R_L = 100\Omega$ see fig 1							$R_L = 1\text{k}\Omega$ see fig 2		
	td	tr	ton	ts	tf	toff	I_C	ton	toff	I_F
	μs	μs	μs	μs	μs	μs	mA	μs	μs	mA
CQY80 CQY80N	4.0	7.0	11.0	0.3	6.7	7.0	5	25.0	42.5	10

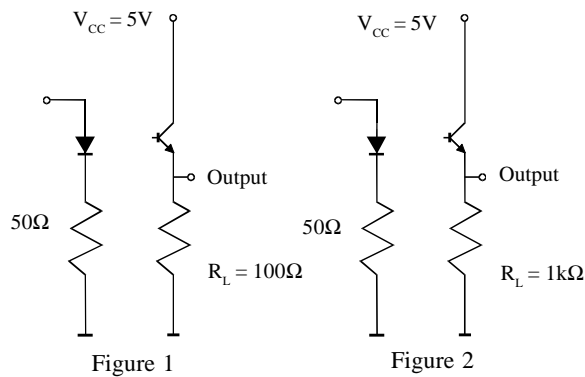

Collector Power Dissipation vs. Ambient Temperature

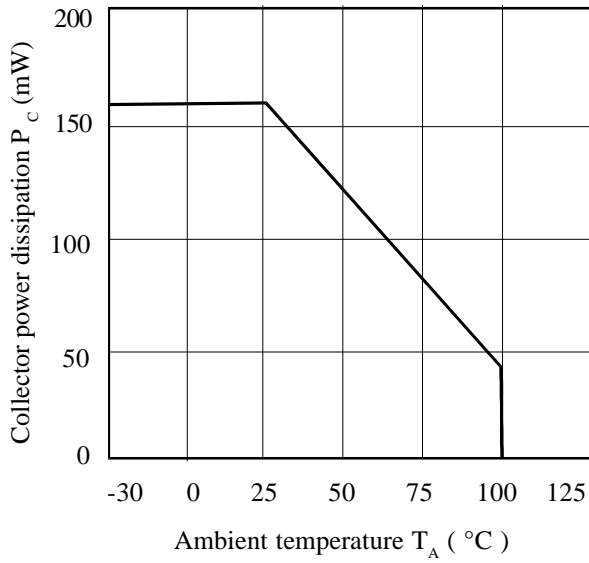

Collector Current vs. Collector-emitter Voltage

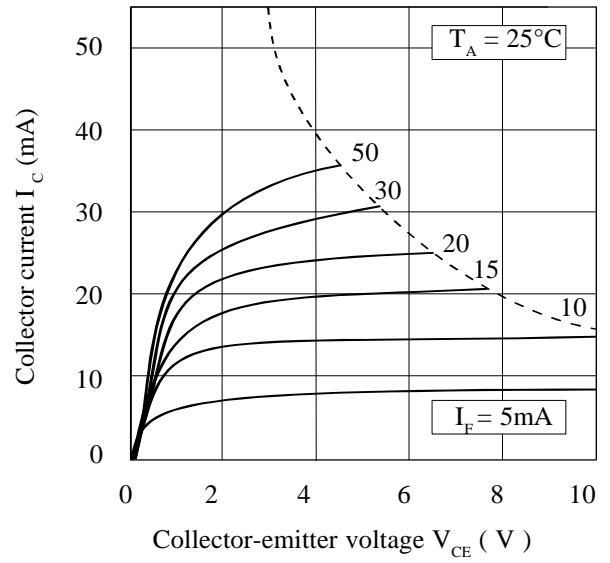

Forward Current vs. Ambient Temperature

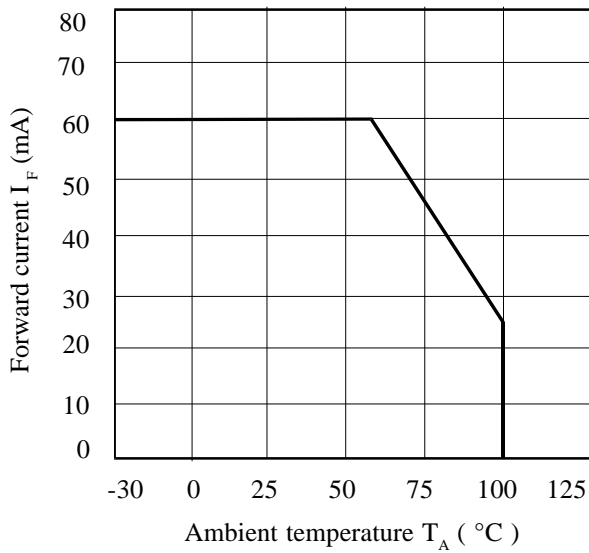

Current Transfer Ratio vs. Forward Current

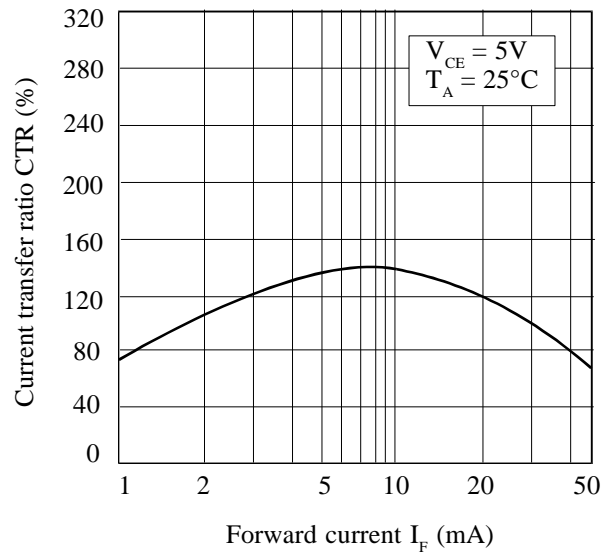

Relative Current Transfer Ratio vs. Ambient Temperature

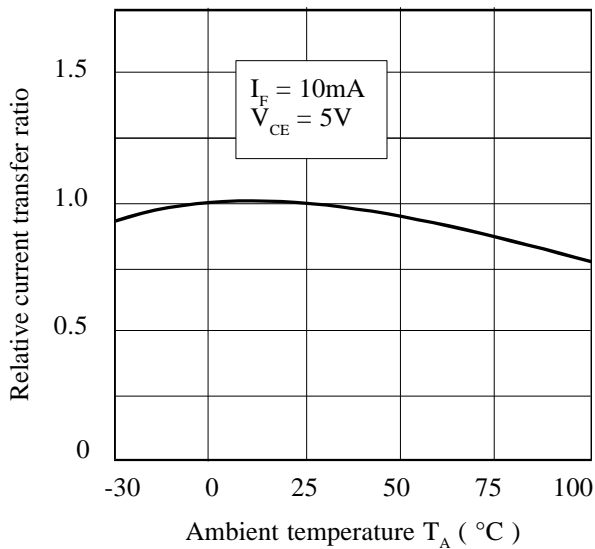

Collector-emitter Saturation Voltage vs. Ambient Temperature

