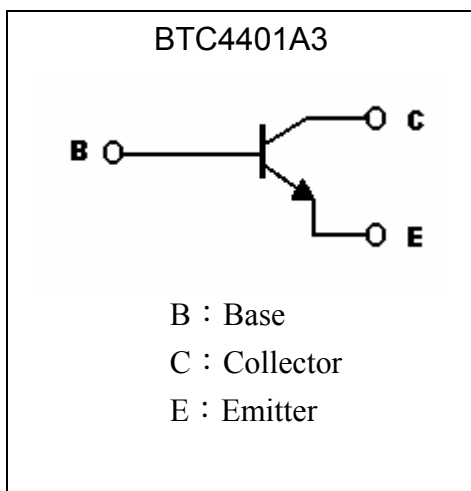
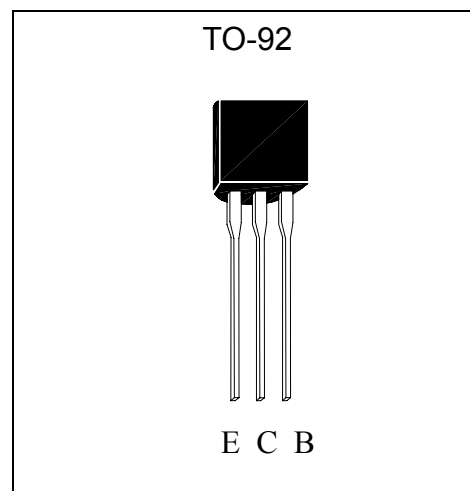

**General Purpose NPN Epitaxial Planar Transistor**

# BTC4401A3

**Description**

- The BTC4401A3 is designed for using in driver stage of AF amplifier and general purpose switching application.
- High current ,  $I_C = 0.6A$
- Low  $V_{CE(sat)}$  ,  $V_{CE(sat)} = 0.2V$ (typ.) at  $I_C/I_B = 500mA/50mA$   
Optimal for low Voltage operation
- Complementary to BTA4403A3.
- Pb-free package

**Symbol**

**Outline**

**Absolute Maximum Ratings** ( $T_a=25^{\circ}C$ )

Parameter	Symbol	Limits	Unit
Collector-Base Voltage	$V_{CBO}$	75	V
Collector-Emitter Voltage	$V_{CEO}$	50	V
Emitter-Base Voltage	$V_{EBO}$	6	V
Collector Current	$I_C$	0.6	A
Power Dissipation	$P_d$	625	mW
Junction Temperature	$T_j$	150	$^{\circ}C$
Storage Temperature	$T_{stg}$	-55~+150	$^{\circ}C$

**Characteristics (Ta=25°C)**

Symbol	Min.	Typ.	Max.	Unit	Test Conditions
BV <sub>CBO</sub>	75	-	-	V	I <sub>C</sub> =100μA
BV <sub>CEO</sub>	50	-	-	V	I <sub>C</sub> =1mA
BV <sub>EBO</sub>	6	-	-	V	I <sub>E</sub> =10μA
I <sub>CBO</sub>	-	-	10	nA	V <sub>CB</sub> =60V
I <sub>CEX</sub>	-	-	100	nA	V <sub>CE</sub> =60V, V <sub>BE</sub> =-0.4V
I <sub>EBO</sub>	-	-	50	nA	V <sub>EB</sub> =5V
*V <sub>CE(sat)1</sub>	-	-	0.3	V	I <sub>C</sub> =150mA, I <sub>B</sub> =15mA
*V <sub>CE(sat)2</sub>	-	0.2	0.45	V	I <sub>C</sub> =500mA, I <sub>B</sub> =50mA
*V <sub>BE(sat)1</sub>	-	-	0.95	V	I <sub>C</sub> =150mA, I <sub>B</sub> =15mA
*V <sub>BE(sat)2</sub>	-	-	1.2	V	I <sub>C</sub> =500mA, I <sub>B</sub> =50mA
*V <sub>BE(ON)</sub>	-	-	1	V	V <sub>CE</sub> =1V, I <sub>C</sub> =20mA
*h <sub>FE1</sub>	100	-	-	-	V <sub>CE</sub> =2V, I <sub>C</sub> =0.1mA
*h <sub>FE2</sub>	120	-	240	-	V <sub>CE</sub> =2V, I <sub>C</sub> =1mA
*h <sub>FE3</sub>	120	-	240	-	V <sub>CE</sub> =2V, I <sub>C</sub> =50mA
*h <sub>FE4</sub>	40	-	-	-	V <sub>CE</sub> =2V, I <sub>C</sub> =500mA
f <sub>T</sub>	-	230	-	MHz	V <sub>CE</sub> =5V, I <sub>C</sub> =20mA, f=100MHz
Cob	-	9.3	-	pF	V <sub>CB</sub> =5V, f=1MHz

\*Pulse Test: Pulse Width ≤380μs, Duty Cycle≤2%

**Classification Of h<sub>FE</sub> 2**

Rank	A	B1	B2	C
Range	120~175	165~195	185~225	215~240

**Ordering Information**

Device	Package	Shipping
BTC4401A3, bulk	TO-92 (Pb-free lead plating package)	1000 pcs/ bag, 10 bags/box, 10boxes/carton
BTC4401A3, T/B	TO-92 (Pb-free lead plating package)	2000 pcs / Tape & Box

**Typical Characteristics**

Emitter Grounded Output Characteristics

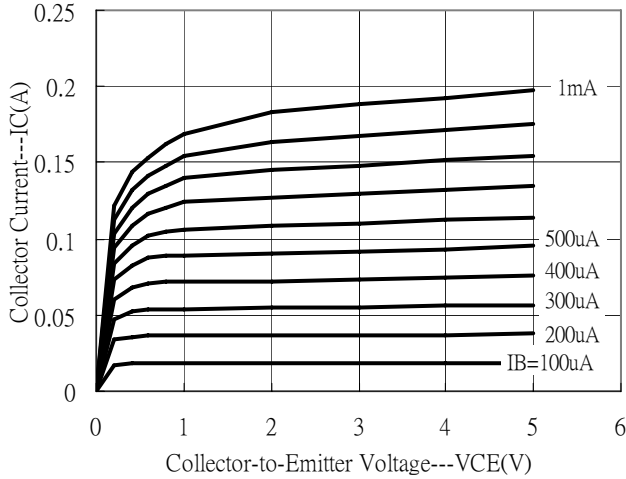

Emitter Grounded Output Characteristics

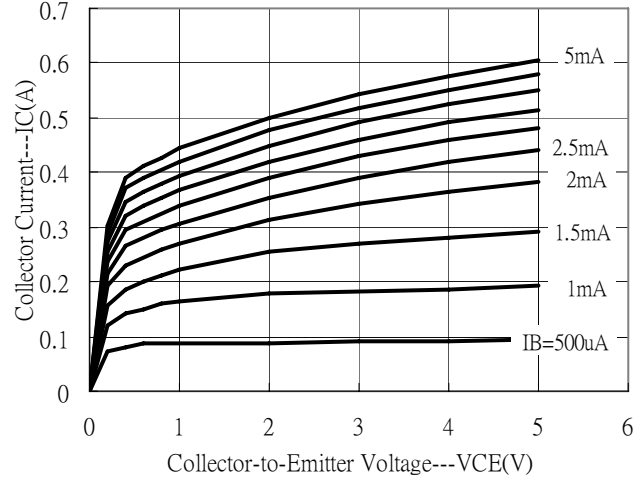

Current Gain vs Collector Current

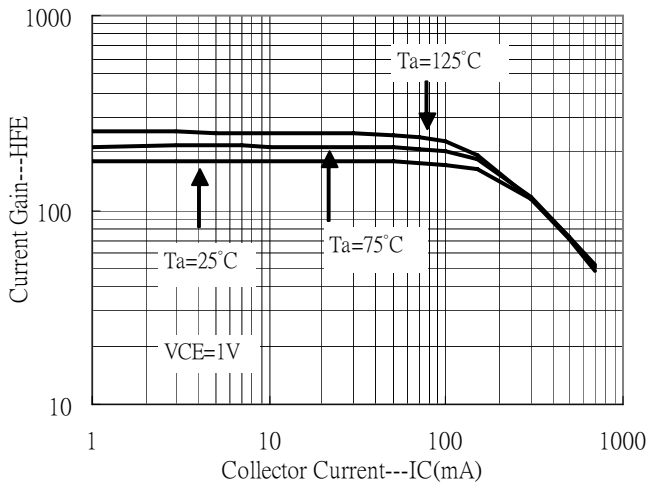

Current Gain vs Collector Current

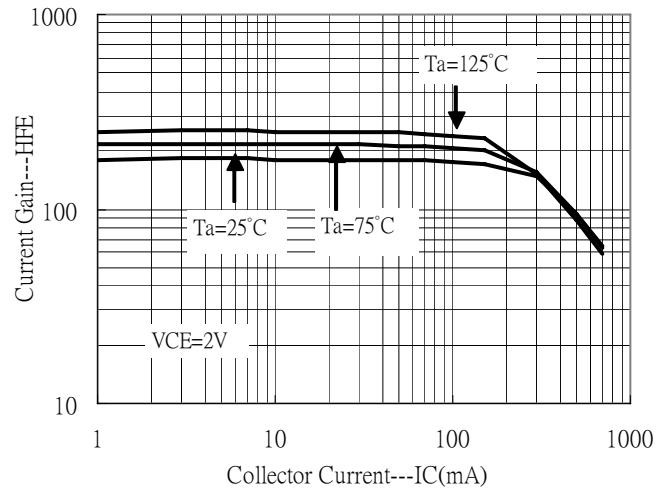

Current Gain vs Collector Current

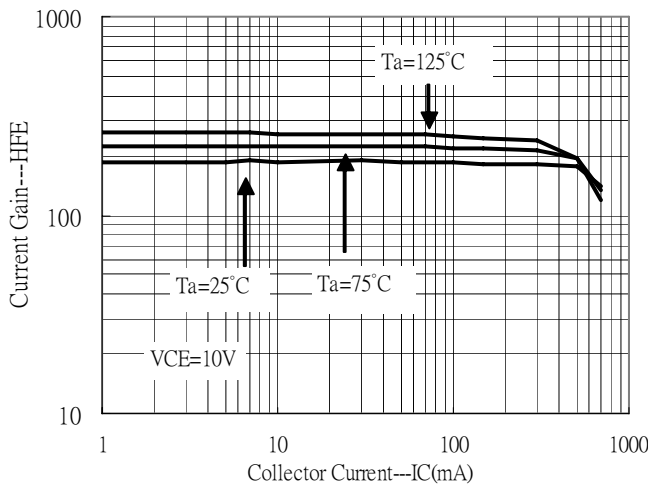

Saturation Voltage vs Collector Current

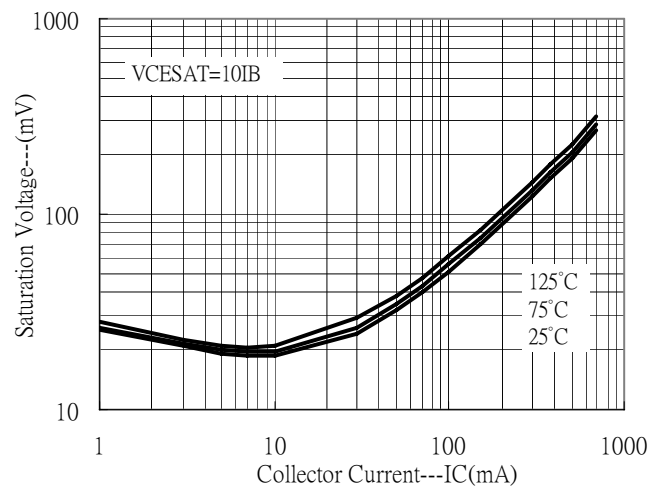

**Typical Characteristics(Cont.)**

Saturation Voltage vs Collector Current

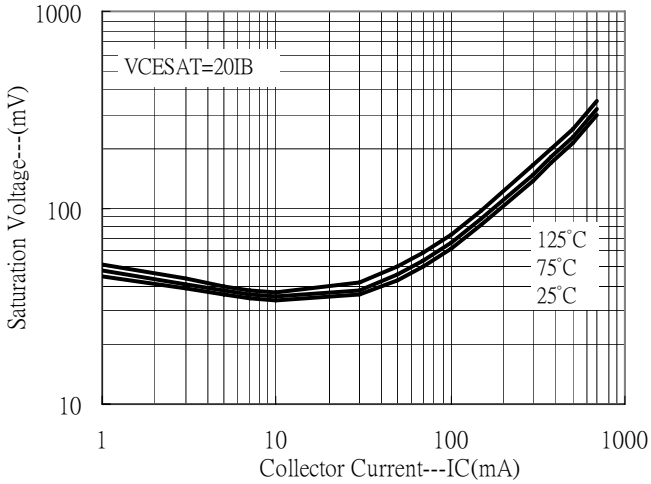

Saturation Voltage vs Collector Current

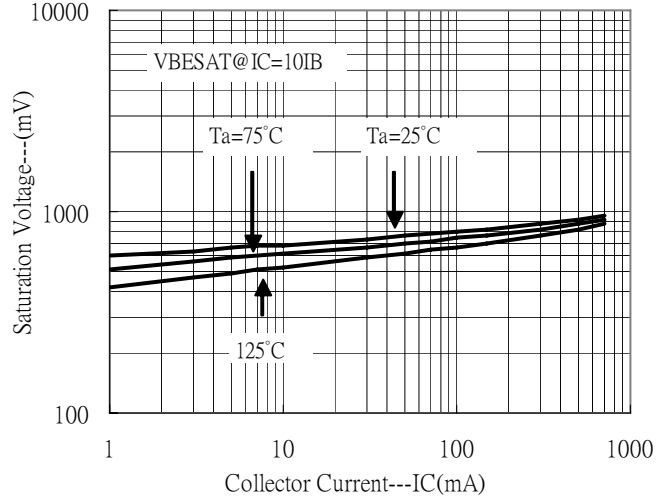

On Voltage vs Collector Current

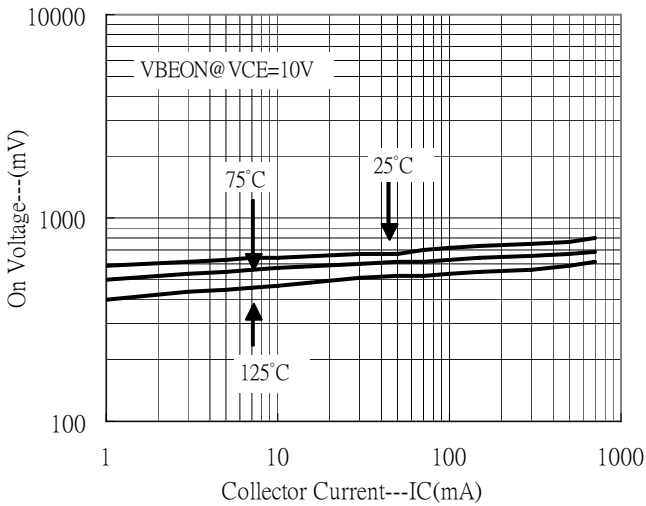

Capacitance vs Reverse-biased Voltage

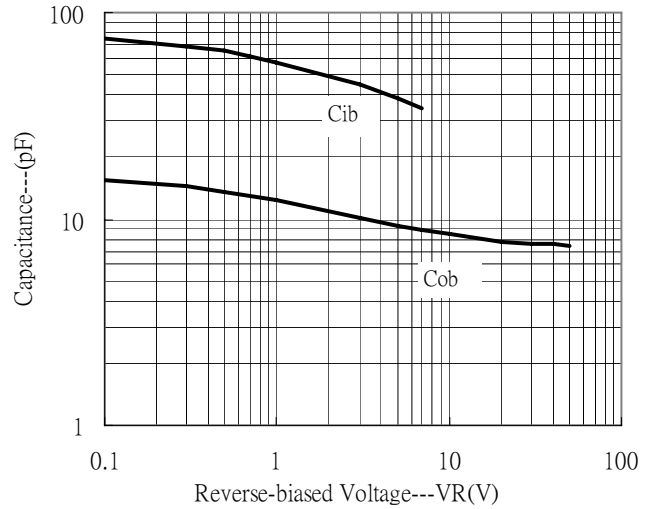

Transition Frequency vs Collector Current

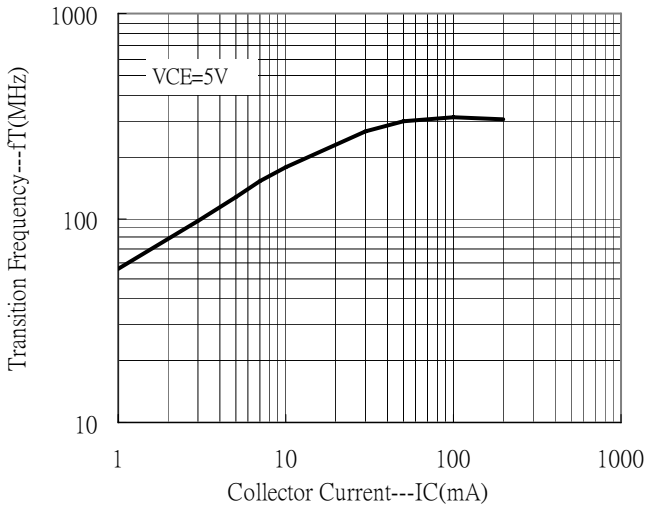

Power Derating Curve

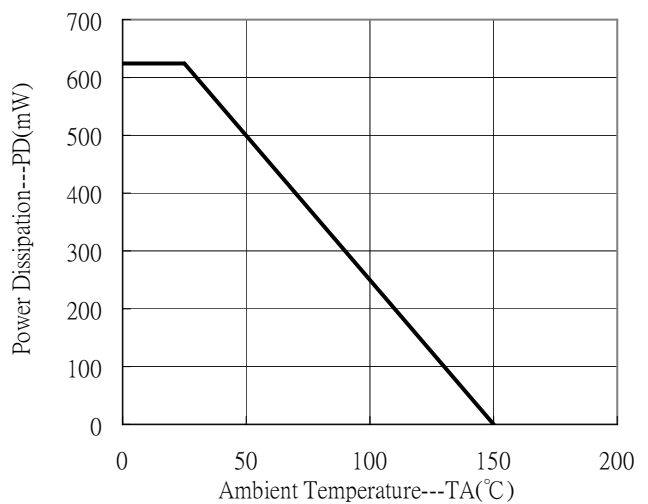

**TO-92 Taping Outline**

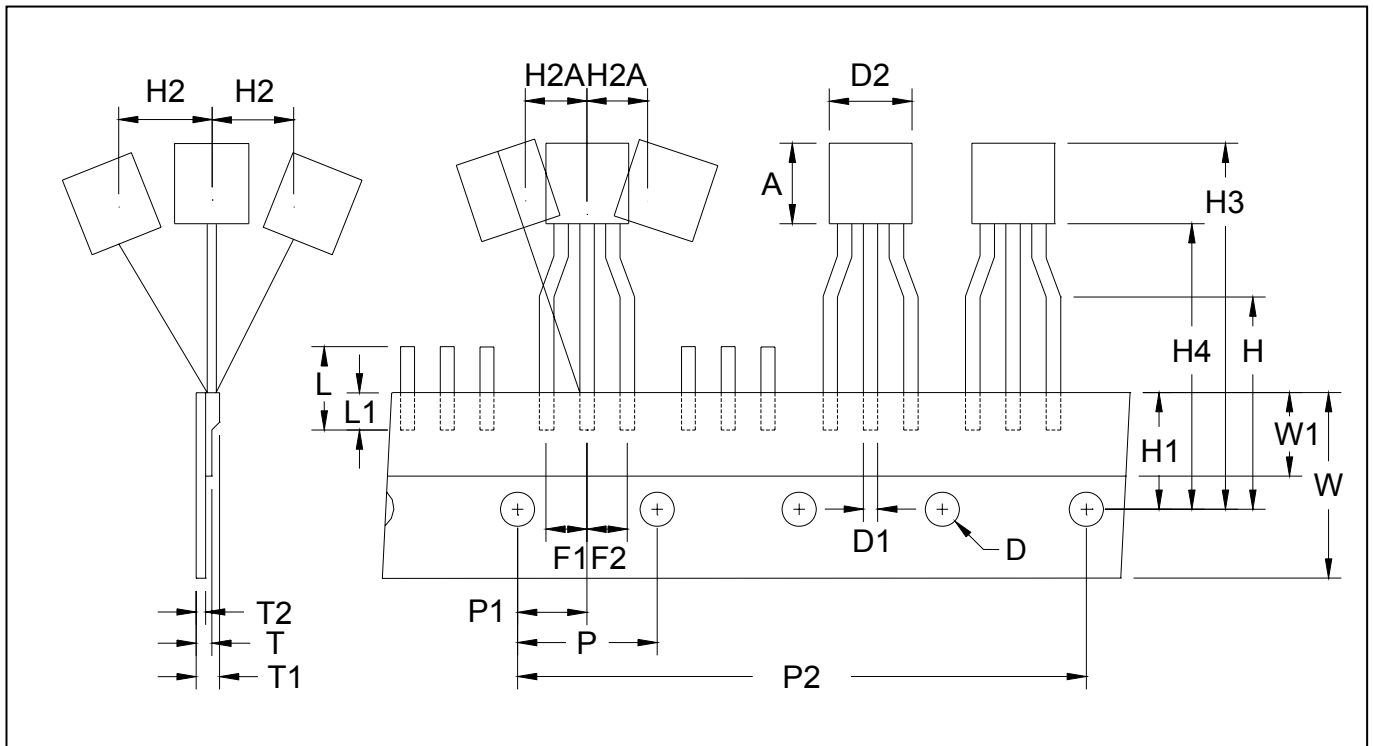

DIM	Item	Millimeters	
		Min.	Max.
A	Component body height	4.33	4.83
D	Tape Feed Diameter	3.80	4.20
D1	Lead Diameter	0.36	0.53
D2	Component Body Diameter	4.33	4.83
F1,F2	Component Lead Pitch	2.40	2.90
F1,F2	F1-F2	-	±0.3
H	Height Of Seating Plane	15.50	16.50
H1	Feed Hole Location	8.50	9.50
H2	Front To Rear Deflection	-	1
H2A	Deflection Left Or Right	-	1
H3	Component Height	-	27
H4	Feed Hole To Bottom Of Component	-	21
L	Lead Length After Component Removal	-	11
L1	Lead Wire Enclosure	2.50	-
P	Feed Hole Pitch	12.50	12.90
P1	Center Of Seating Plane Location	5.95	6.75
P2	4 Feed Hole Pitch	50.30	51.30
T	Over All Tape Thickness	-	0.55
T1	Total Taped Package Thickness	-	1.42
T2	Carrier Tape Thickness	0.36	0.68
W	Tape Width	17.50	19.00
W1	Adhesive Tape Width	5.00	7.00
-	20 pcs Pitch	253	255

**Recommended wave soldering condition**

Product	Peak Temperature	Soldering Time
Pb-free devices	260 +0/-5 °C	5 +1/-1 seconds

**Recommended temperature profile for IR reflow**

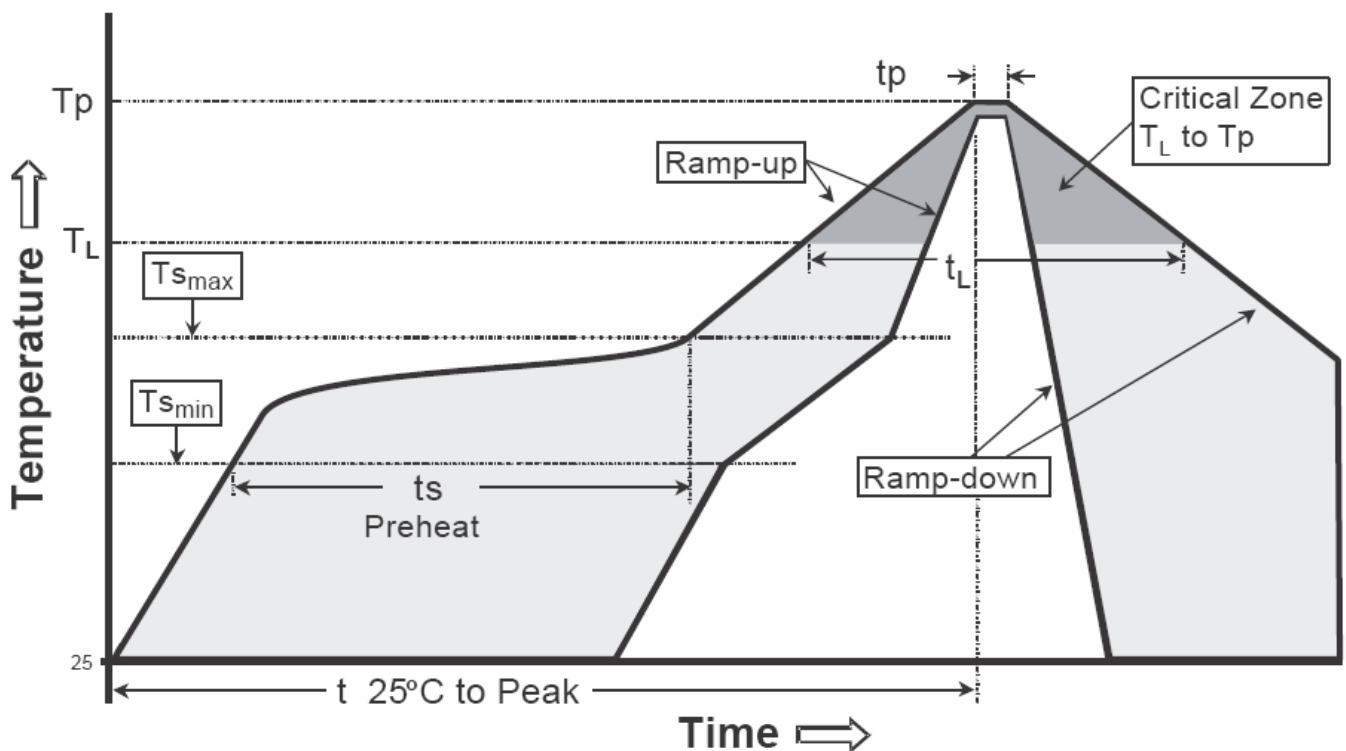

Profile feature	Sn-Pb eutectic Assembly	Pb-free Assembly
Average ramp-up rate (T <sub>smax</sub> to T <sub>p</sub> )	3°C/second max.	3°C/second max.
Preheat		
-Temperature Min(T <sub>s min</sub> )	100°C	150°C
-Temperature Max(T <sub>s max</sub> )	150°C	200°C
-Time(t <sub>s min</sub> to t <sub>s max</sub> )	60-120 seconds	60-180 seconds
Time maintained above:		
-Temperature (T <sub>L</sub> )	183°C	217°C
- Time (t <sub>L</sub> )	60-150 seconds	60-150 seconds
Peak Temperature(T <sub>P</sub> )	240 +0/-5 °C	260 +0/-5 °C
Time within 5°C of actual peak temperature(tp)	10-30 seconds	20-40 seconds
Ramp down rate	6°C/second max.	6°C/second max.
Time 25 °C to peak temperature	6 minutes max.	8 minutes max.

Note : All temperatures refer to topside of the package, measured on the package body surface.

**TO-92 Dimension**

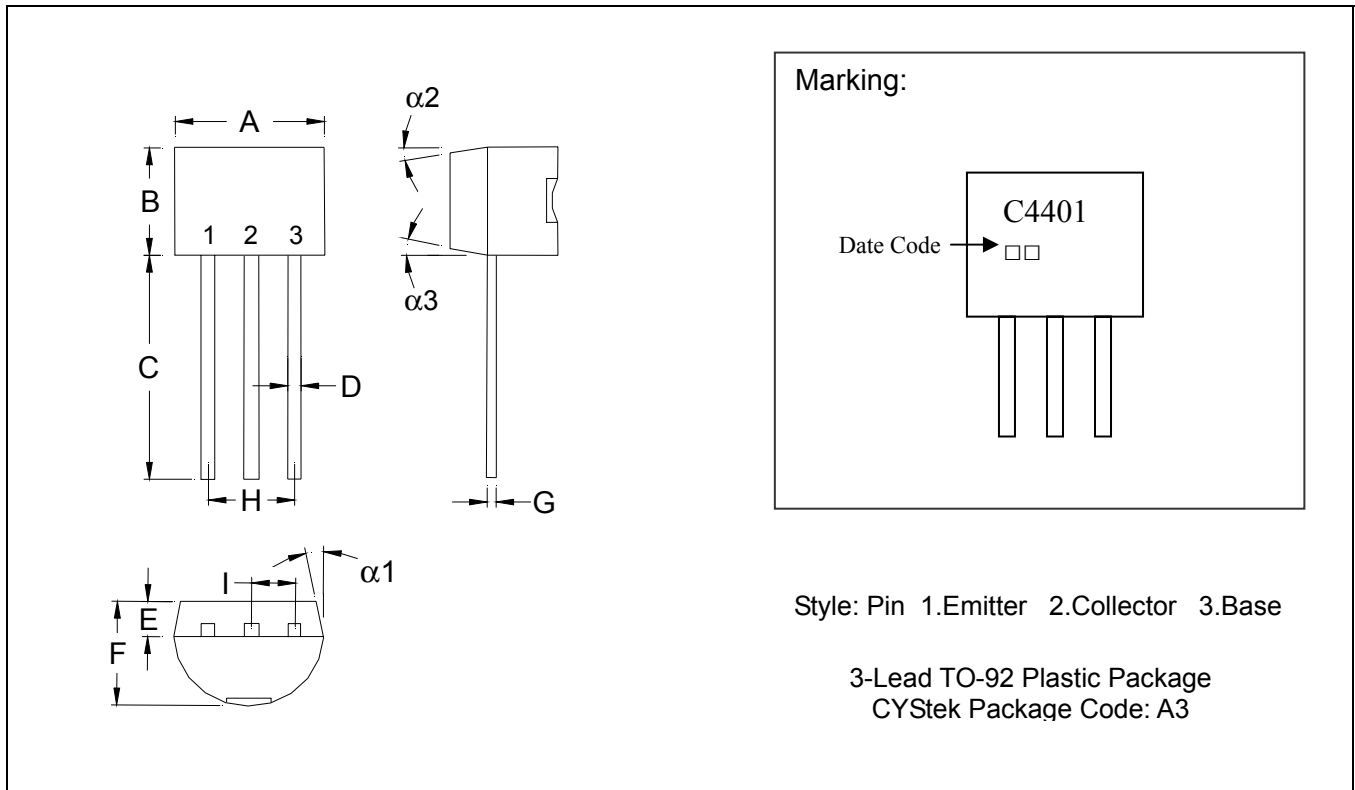

\*: Typical

DIM	Inches		Millimeters		DIM	Inches		Millimeters	
	Min.	Max.	Min.	Max.		Min.	Max.	Min.	Max.
A	0.1704	0.1902	4.33	4.83	G	0.0142	0.0220	0.36	0.56
B	0.1704	0.1902	4.33	4.83	H	-	*0.1000	-	*2.54
C	0.5000	-	12.70	-	I	-	*0.0500	-	*1.27
D	0.0142	0.0220	0.36	0.56	$\alpha 1$	-	*5°	-	*5°
E	-	*0.0500	-	*1.27	$\alpha 2$	-	*2°	-	*2°
F	0.1323	0.1480	3.36	3.76	$\alpha 3$	-	*2°	-	*2°

**Notes:** 1. Controlling dimension: millimeters.  
 2. Maximum lead thickness includes lead finish thickness, and minimum lead thickness is the minimum thickness of base material.  
 3. If there is any question with packing specification or packing method, please contact your local CYStek sales office.

**Material:**

- Lead: Pure tin plated.
- Mold Compound: Epoxy resin family, flammability solid burning class: UL94V-0.

**Important Notice:**

- All rights are reserved. Reproduction in whole or in part is prohibited without the prior written approval of CYStek.
- CYStek reserves the right to make changes to its products without notice.
- CYStek **semiconductor products are not warranted to be suitable for use in Life-Support Applications, or systems.**
- CYStek assumes no liability for any consequence of customer product design, infringement of patents, or application assistance.