

Features

- Peak pulse power:
 - 400 W (10/1000 μ s)
 - 2.3 kW (8/20 μ s)
- Stand-off voltage range: from 5 V to 70 V
- Unidirectional and bidirectional types
- Low leakage current:
 - 0.2 μ A at 25 °C
 - 1 μ A at 85 °C
- Operating $T_{j\max}$: 150 °C
- High power capability at $T_{j\max}$:
 - 270 W (10/1000 μ s)
- JEDEC registered package outline
- Resin meets UL 94, V0
- AEC-Q101 qualified

Complies with the following standards

- ISO 10605, C = 150 pF, R = 330 Ω :
 - 30 kV (air discharge)
 - 30 kV (contact discharge)
- ISO 10605, C = 330 pF, R = 330 Ω :
 - 30 kV (air discharge)
 - 30 kV (contact discharge)
- ISO 7637-2^(a)
 - pulse 1: $V_S = -100$ V
 - pulse 2a: $V_S = +50$ V
 - pulse 3a: $V_S = -150$ V
 - pulse 3b: $V_S = +100$ V

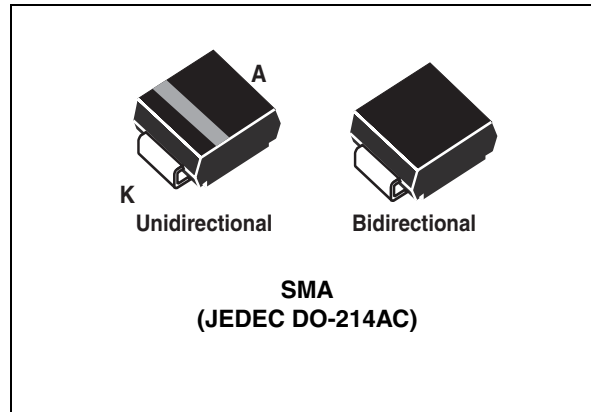

Description

The SM4TY Transil series has been designed to protect sensitive automotive circuits against surges defined in ISO 7637-2 and against electrostatic discharges according to ISO 10605.

The planar technology makes it compatible with high-end circuits where low leakage current and high junction temperature are required to provide reliability and stability over time. SM4TY devices are packaged in SMA (SMA footprint in accordance with IPC 7531 standard).

a. Not applicable to parts with stand-off voltage lower than the average battery voltage (13.5 V)

™: Transil is a trademark of STMicroelectronics

1 Characteristics

Table 1. Absolute maximum ratings ($T_{amb} = 25\text{ }^{\circ}\text{C}$)

| Symbol | Parameter | | Value | Unit |
|-------------------|---|--|--------------|--------------------|
| V_{PP} | Peak pulse voltage | ISO 10605 ($C = 150\text{ pF}, R = 330\text{ }\Omega$) | | |
| | | Contact discharge | 30 | kV |
| | | Air discharge | 30 | |
| | | ISO 10605, $C = 150\text{ pF}, R = 330\text{ }\Omega$: | | |
| Contact discharge | 30 | | | |
| P_{PP} | Peak pulse power dissipation ⁽¹⁾ | $T_{j\text{ initial}} = T_{amb}$ | 400 | W |
| | | | | |
| T_{stg} | Storage temperature range | | -65 to + 150 | $^{\circ}\text{C}$ |
| T_j | Operating junction temperature range | | -55 to + 150 | $^{\circ}\text{C}$ |
| T_L | Maximum lead temperature for soldering during 10 s. | | 260 | $^{\circ}\text{C}$ |

1. For a surge greater than the maximum values, the diode will fail in short-circuit.

Figure 1. Electrical characteristics - definitions

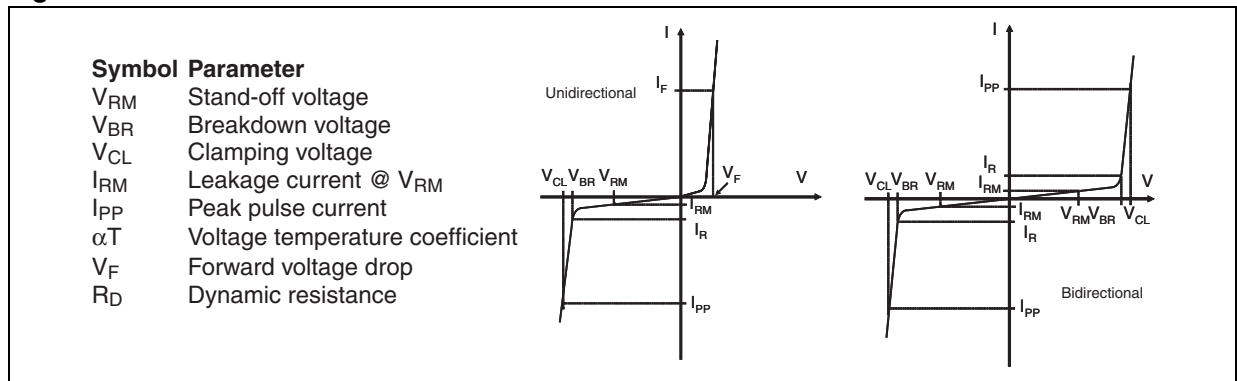

Figure 2. Pulse definition for electrical characteristics

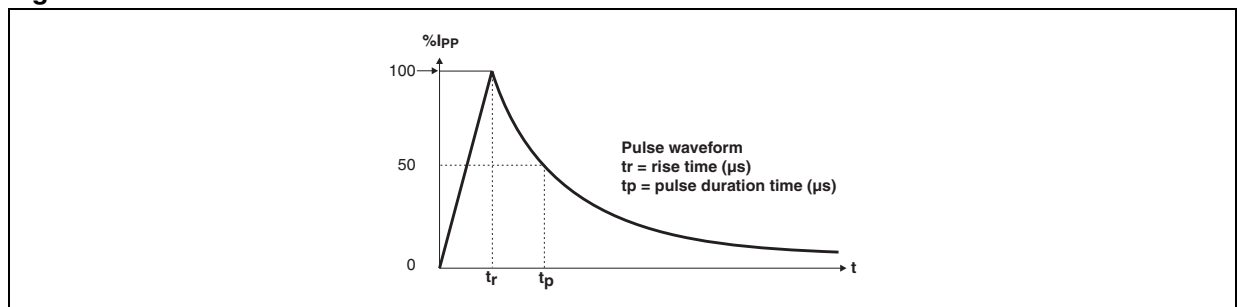

Table 2. Electrical characteristics, typical values if not otherwise stated (T_{amb} = 25 °C)

| Order code | I _{RM} max @ V _{RM} | | V _{BR} @ I _R ⁽¹⁾ | | | | V _{CL} @ I _{PP} 10/1000 μs | | R _D 10/1000 μs | V _{CL} @ I _{PP} 8/20 μs | | R _D 8/20 μs | αT ⁽²⁾ | |
|---------------|---------------------------------------|-------|---|------|------|------|---|------------------|---------------------------------|--|------------------|------------------------------|-------------------|-------------|
| | 25 °C | 85 °C | min. | typ. | max. | max. | | | max. | | | max | | |
| | μA | | V | V | | | mA | V ⁽³⁾ | A ⁽⁴⁾ | Ω | V ⁽³⁾ | A ⁽⁴⁾ | Ω | 10-4/ °C |
| SM4T6V7AY/CAY | 20 | 50 | 5 | 6.4 | 6.74 | 7.1 | 10 | 9.2 | 43.5 | 0.049 | 13.4 | 174 | 0.036 | 5.7 |
| SM4T7V6AY/CAY | 20 | 50 | 6.5 | 7.2 | 7.58 | 8.0 | 10 | 11.2 | 35.7 | 0.091 | 14.5 | 160 | 0.041 | 6.1 |
| SM4T10AY/CAY | 20 | 50 | 8.5 | 9.4 | 9.9 | 10.4 | 1 | 14.4 | 27.7 | 0.145 | 19.5 | 124 | 0.073 | 7.3 |
| SM4T12AY/CAY | 0.2 | 1 | 10 | 11.1 | 11.7 | 12.3 | 1 | 17.0 | 23.5 | 0.201 | 21.7 | 106 | 0.089 | 7.8 |
| SM4T14AY/CAY | 0.2 | 1 | 12 | 13.3 | 14.0 | 14.7 | 1 | 19.9 | 20.1 | 0.259 | 25.3 | 91 | 0.116 | 8.3 |
| SM4T15AY/CAY | 0.2 | 1 | 13 | 14.4 | 15.2 | 16.0 | 1 | 21.5 | 18.6 | 0.298 | 27.2 | 85 | 0.132 | 8.4 |
| SM4T18AY/CAY | 0.2 | 1 | 15 | 16.7 | 17.6 | 18.5 | 1 | 24.4 | 16.4 | 0.361 | 32.5 | 71 | 0.197 | 8.8 |
| SM4T21AY/CAY | 0.2 | 1 | 18 | 20.0 | 21.1 | 22.2 | 1 | 29.2 | 13.7 | 0.514 | 39.3 | 59 | 0.291 | 9.2 |
| SM4T23AY/CAY | 0.2 | 1 | 20 | 22.2 | 23.4 | 24.6 | 1 | 32.4 | 12.3 | 0.637 | 42.8 | 54 | 0.338 | 9.4 |
| SM4T26AY/CAY | 0.2 | 1 | 22 | 24.4 | 25.7 | 27.0 | 1 | 35.5 | 11.2 | 0.760 | 48.3 | 48 | 0.444 | 9.6 |
| SM4T28AY/CAY | 0.2 | 1 | 24 | 26.7 | 28.1 | 29.5 | 1 | 38.9 | 10.3 | 0.912 | 50 | 46 | 0.446 | 9.6 |
| SM4T30AY/CAY | 0.2 | 1 | 26 | 28.9 | 30.4 | 31.9 | 1 | 42.1 | 9.5 | 1.07 | 53.5 | 43 | 0.502 | 9.7 |
| SM4T33AY/CAY | 0.2 | 1 | 28 | 31.1 | 32.7 | 34.3 | 1 | 45.4 | 8.8 | 1.26 | 59 | 39 | 0.632 | 9.8 |
| SM4T35AY/CAY | 0.2 | 1 | 30 | 33.3 | 35.1 | 36.9 | 1 | 48.4 | 8.3 | 1.39 | 64.3 | 36 | 0.762 | 9.9 |
| SM4T39AY/CAY | 0.2 | 1 | 33 | 36.7 | 38.6 | 40.5 | 1 | 53.3 | 7.5 | 1.70 | 69.7 | 33 | 0.884 | 10 |
| SM4T47AY/CAY | 0.2 | 1 | 40 | 44.4 | 46.7 | 49.0 | 1 | 64.5 | 6.2 | 2.49 | 84 | 27 | 1.30 | 10.1 |
| SM4T50AY/CAY | 0.2 | 1 | 43 | 47.8 | 50.3 | 52.8 | 1 | 69.4 | 5.7 | 2.91 | 91 | 25 | 1.53 | 10.2 |
| SM4T56AY/CAY | 0.2 | 1 | 48 | 53.3 | 56.1 | 58.9 | 1 | 77.4 | 5.2 | 3.56 | 100 | 23 | 1.79 | 10.3 |
| SM4T68AY/CAY | 0.2 | 1 | 58 | 64.4 | 67.8 | 71.2 | 1 | 93.6 | 4.3 | 5.21 | 121 | 19 | 2.62 | 10.4 |
| SM4T82AY/CAY | 0.2 | 1 | 70 | 77.8 | 81.9 | 86.0 | 1 | 113 | 3.5 | 7.72 | 146 | 16 | 3.75 | 10.5 |

1. Pulse test: t_p < 50 ms
2. To calculate maximum clamping voltage at other surge level, use the following formula: V_{CLmax} = V_{CL} - R_D × (I_{PP} - I_{PPappli})
where I_{PPappli} is the surge current in the application
3. To calculate V_{BR} or V_{CL} versus junction temperature, use the following formulas:
V_{BR} @ T_J = V_{BR} @ 25 °C × (1 + α_T × (T_J - 25))
V_{CL} @ T_J = V_{CL} @ 25 °C × (1 + α_T × (T_J - 25))
4. Surge capability given for both directions for unidirectional and bidirectional types.

Figure 3. Peak pulse power dissipation versus initial junction temperature

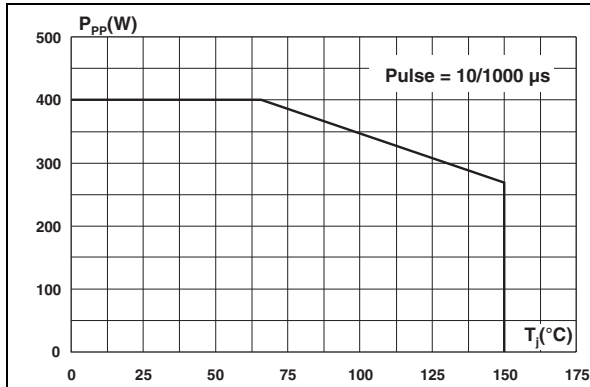

Figure 4. Peak pulse power versus exponential pulse duration (T_j initial = 25 °C)

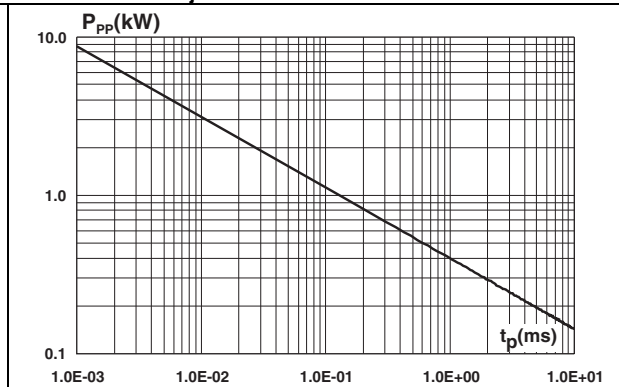

Figure 5. Clamping voltage versus peak pulse current (exponential waveform, maximum values)

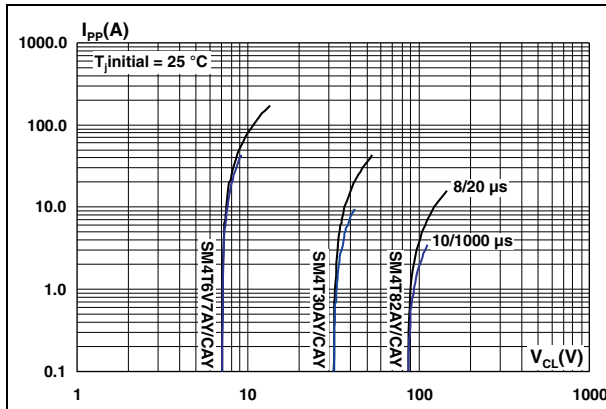

Figure 6. Junction capacitance versus reverse applied voltage for unidirectional types (typical values)

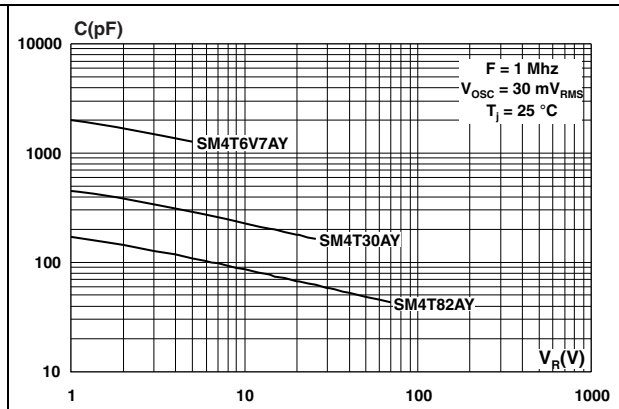

Figure 7. Junction capacitance versus reverse applied voltage for bidirectional types (typical values)

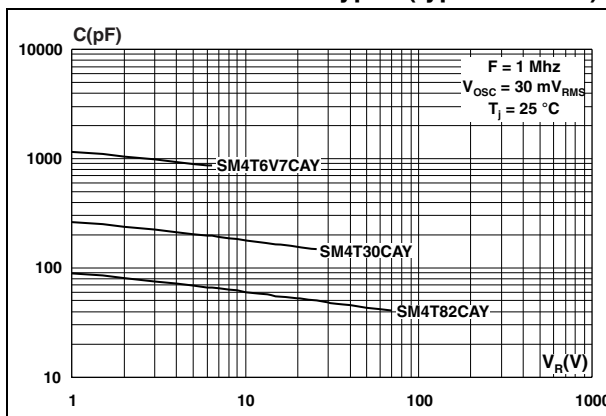

Figure 8. Relative variation of thermal impedance, junction to ambient, versus pulse duration

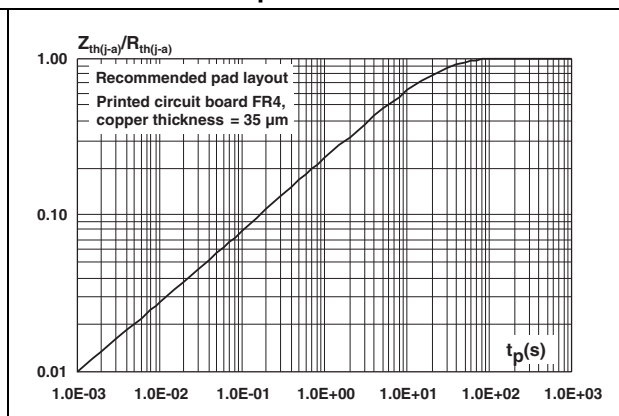

Figure 9. Thermal resistance junction to ambient versus copper surface under each lead

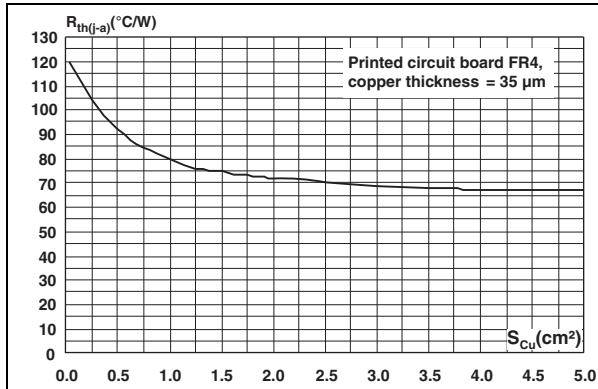

Figure 10. Leakage current versus junction temperature (typical values)

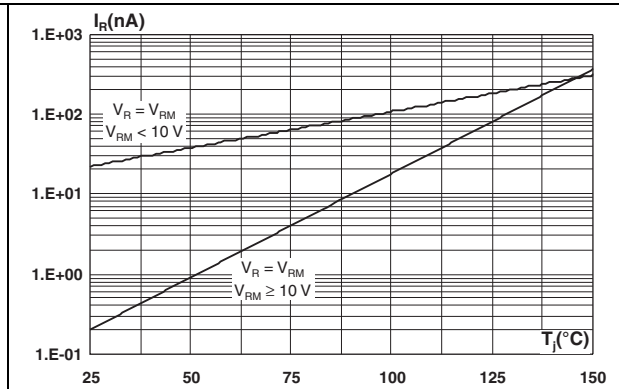

Figure 11. Peak forward voltage drop versus peak forward current (typical values)

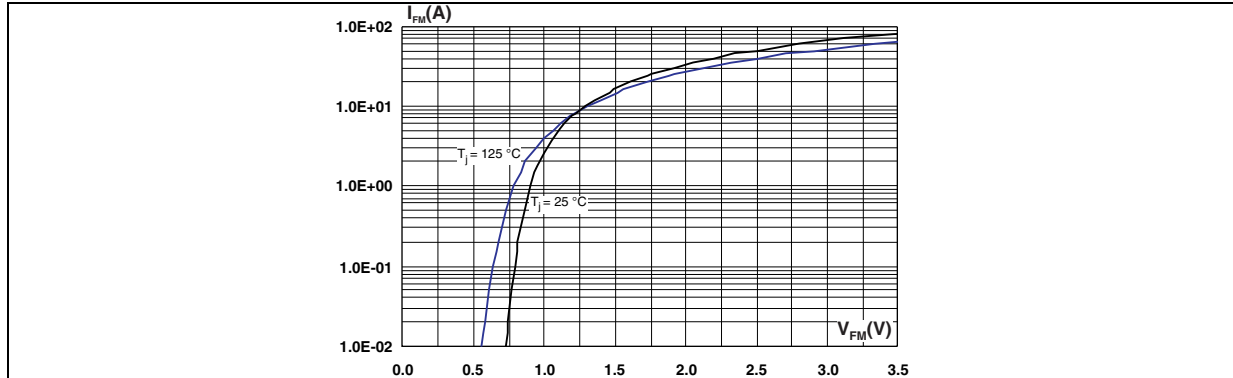

Figure 12. ISO7637-2 pulse 1 response ($V_S = -100\text{ V}$)

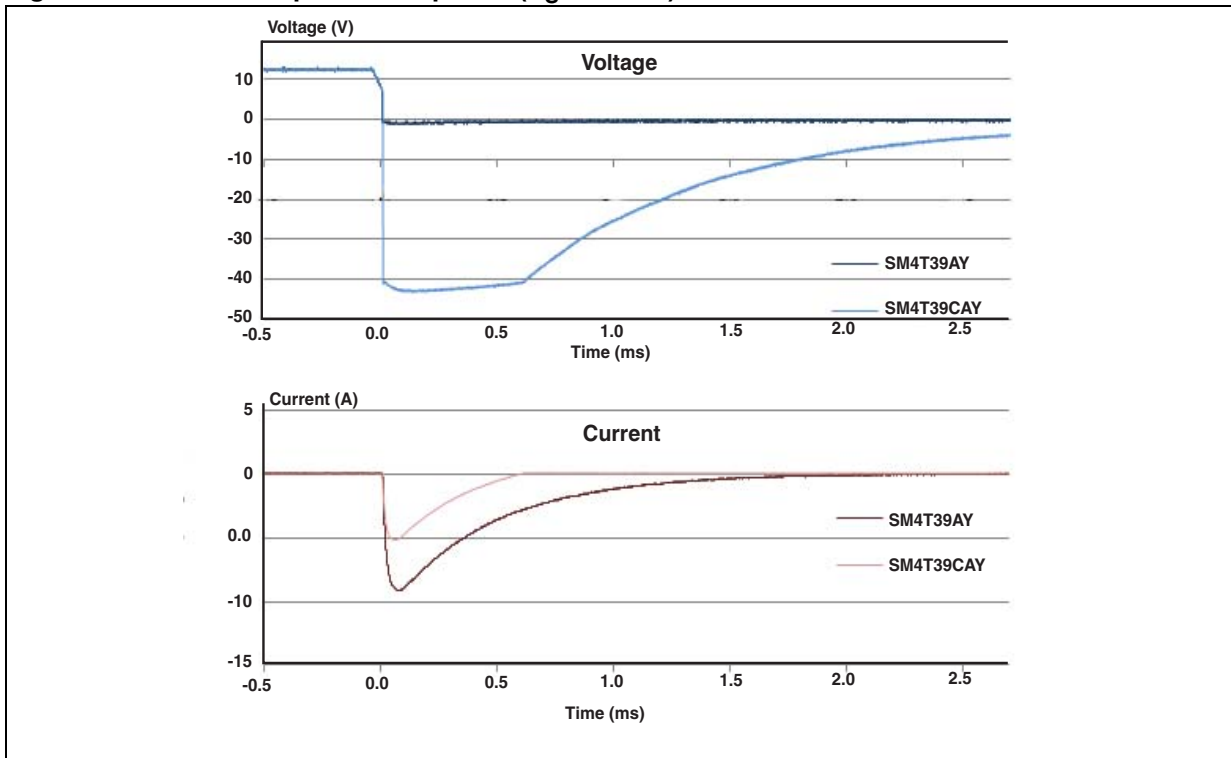

Figure 13. ISO7637-2 pulse 2a response ($V_S = 50\text{ V}$)

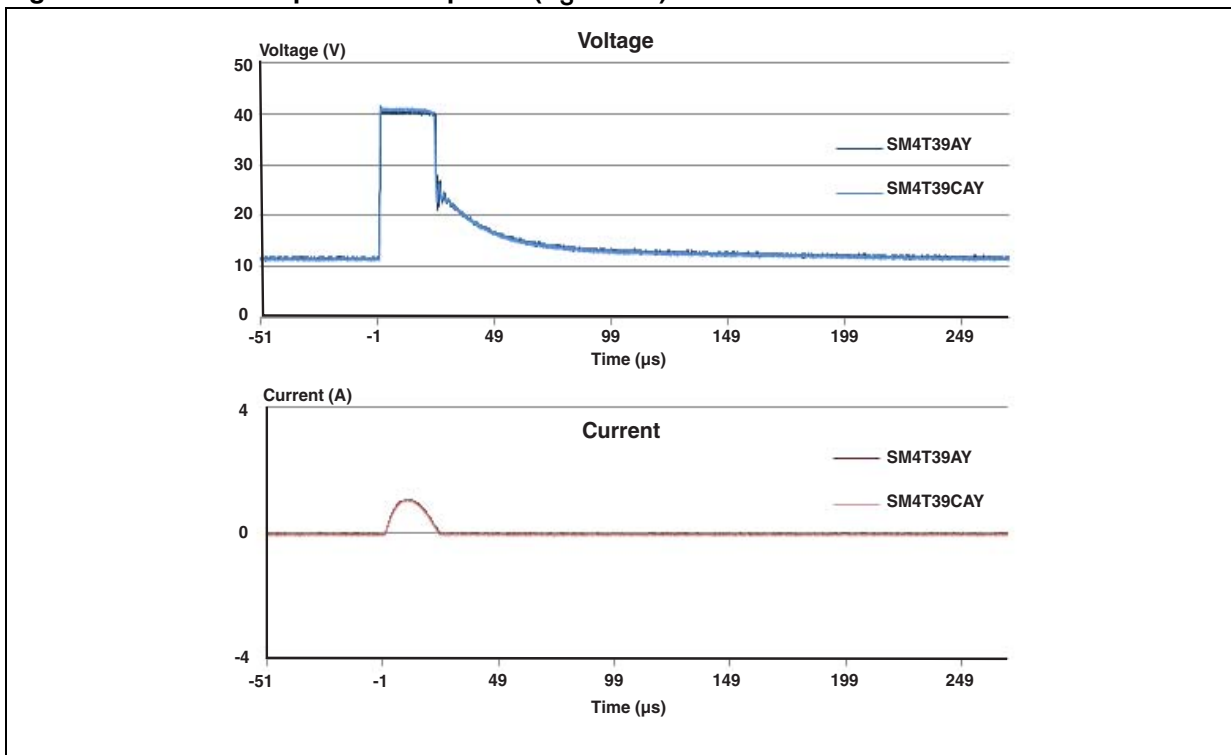

Figure 14. ISO7637-2 pulse 3a response ($V_S = -150\text{ V}$)

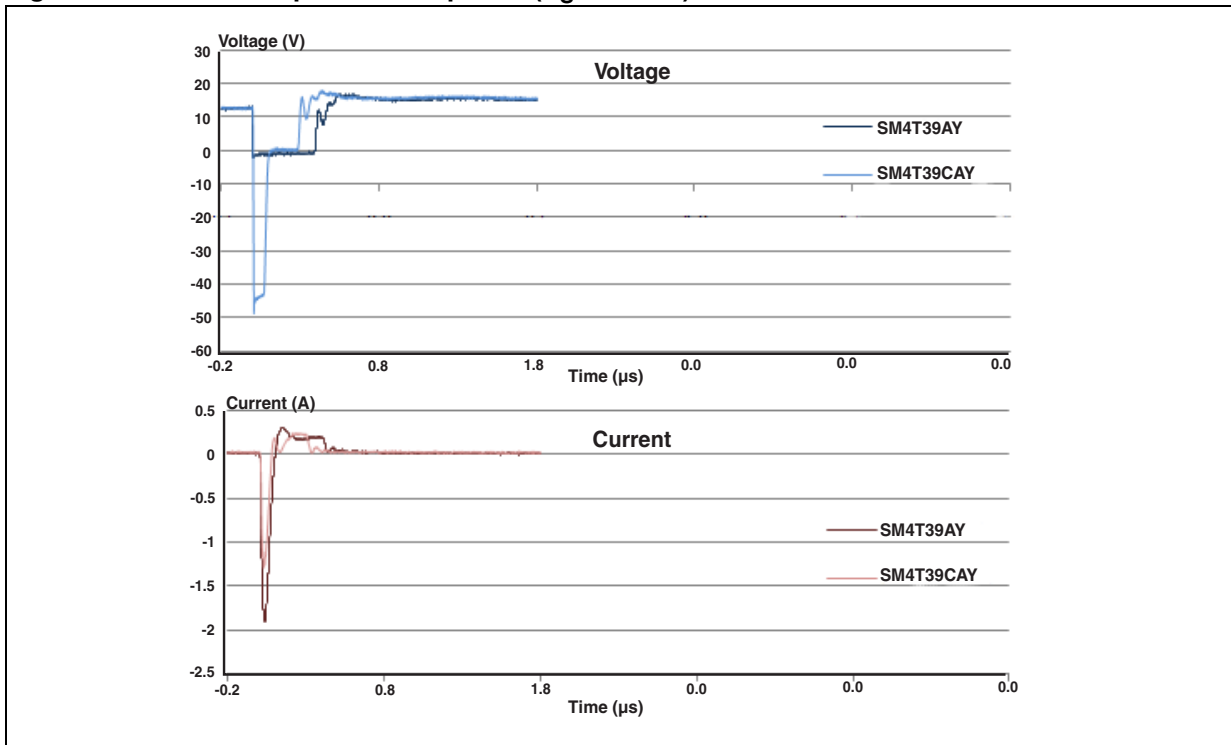
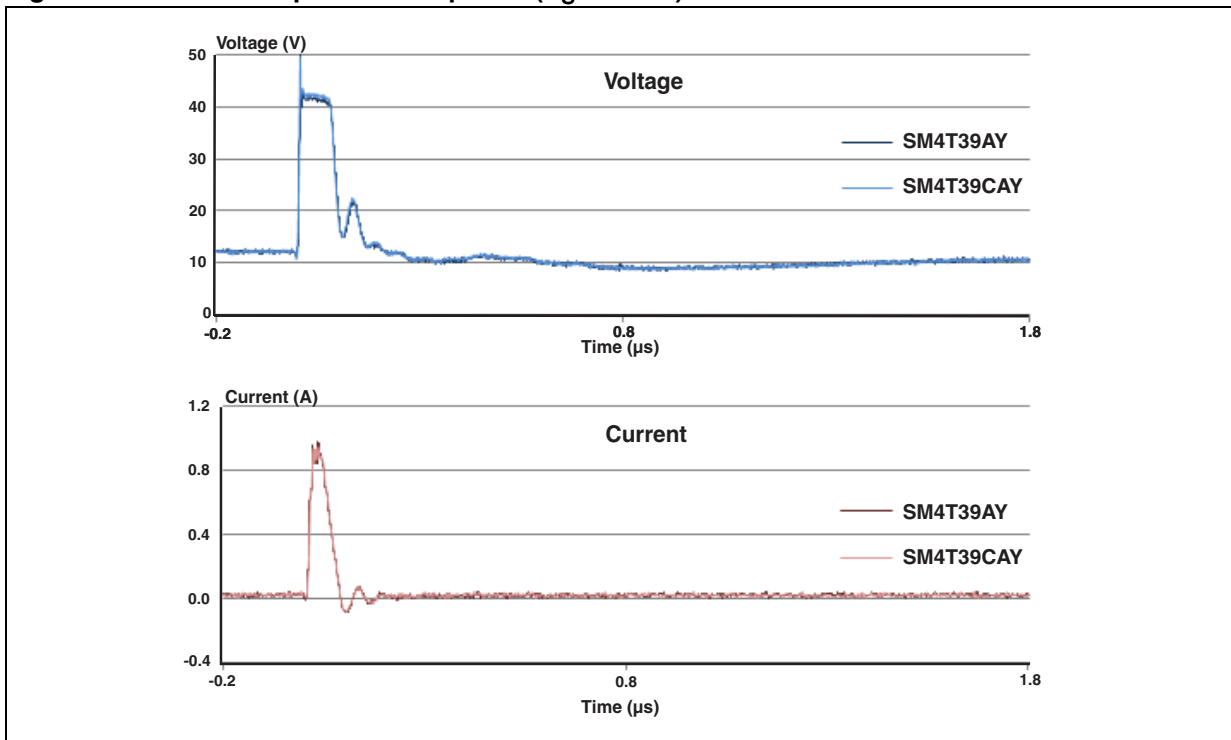

Figure 15. ISO7637-2 pulse 3b response ($V_S = 100\text{ V}$)



Note: ISO7637-2 pulses responses are not applicable for product with a stand off voltage lower than the average battery voltage (13.5 V).

2 Application and design guidelines

More information is available in the Application note AN2689 “Protection of automotive electronics from electrical hazards, guidelines for design and component selection”.

3 Ordering information scheme

Figure 16. Ordering information scheme

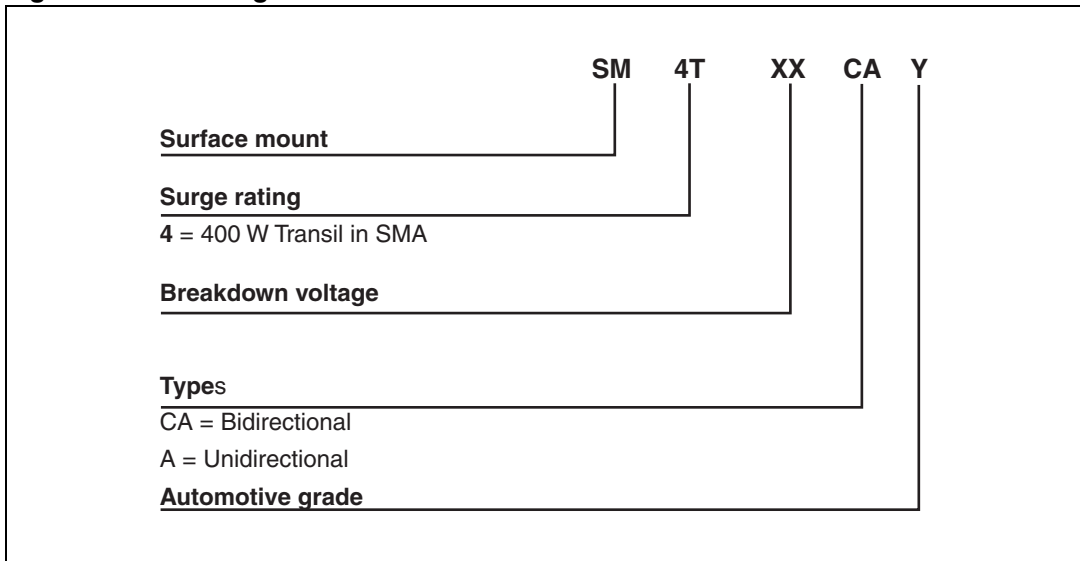

4 Package information

- Case: JEDEC DO-214AB molded plastic over planar junction
- Terminals: solder plated, solderable as per MIL-STD-750, Method 2026
- Polarity: for unidirectional types the band indicates cathode
- Flammability: epoxy is rated UL 94, V0
- RoHS package

In order to meet environmental requirements, ST offers these devices in different grades of ECOPACK® packages, depending on their level of environmental compliance. ECOPACK® specifications, grade definitions and product status are available at: www.st.com. ECOPACK® is an ST trademark.

Table 3. SMA dimensions

| Ref. | Dimensions | | | |
|------|-------------|------|--------|-------|
| | Millimeters | | Inches | |
| | Min. | Max. | Min. | Max. |
| A1 | 1.90 | 2.45 | 0.075 | 0.094 |
| A2 | 0.05 | 0.20 | 0.002 | 0.008 |
| b | 1.25 | 1.65 | 0.049 | 0.065 |
| c | 0.15 | 0.40 | 0.006 | 0.016 |
| D | 2.25 | 2.90 | 0.089 | 0.114 |
| E | 4.80 | 5.35 | 0.189 | 0.211 |
| E1 | 3.95 | 4.60 | 0.156 | 0.181 |
| L | 0.75 | 1.50 | 0.030 | 0.059 |

Figure 17. SMA footprint dimensions in mm (inches) **Figure 18. Marking layout⁽¹⁾**

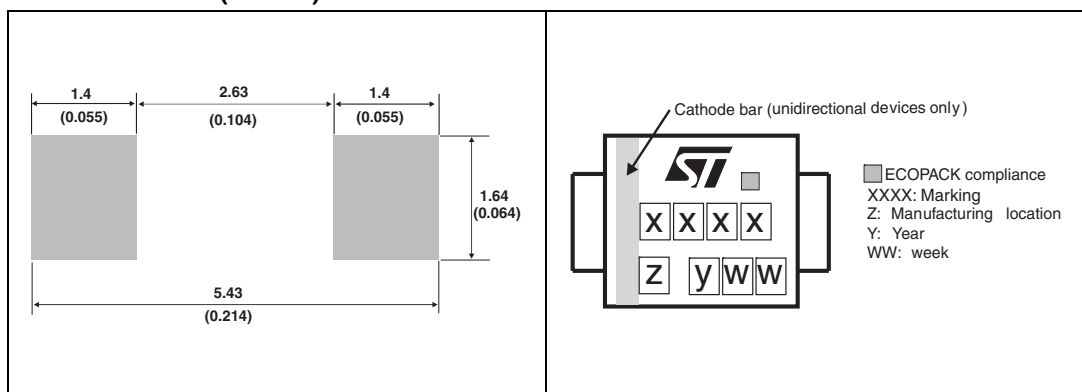

1. Marking layout can vary according to assembly location.

Table 4. Marking

| Order code | Marking | Order code | Marking |
|------------|---------|------------|---------|
| SM4T6V7AY | AEY | SM4T6V7CAY | AAV |
| SM4T7V6AY | DUCY | SM4T7V5CAY | DBCY |
| SM4T10AY | DUHY | SM4T10CAY | DBHY |
| SM4T12AY | AXY | SM4T12CAY | ACY |
| SM4T14AY | DUKY | SM4T14CAY | DBKY |
| SM4T15AY | BGY | SM4T15CAY | BHY |
| SM4T18AY | BMY | SM4T18CAY | AJY |
| SM4T21AY | DUQY | SM4T21CAY | DBQY |
| SM4T23AY | DURY | SM4T23CAY | DBRY |
| SM4T26AY | DUSY | SM4T26CAY | DBSY |
| SM4T28AY | DUTY | SM4T28CAY | DBTY |
| SM4T30AY | DUJY | SM4T30CAY | DBUY |
| SM4T33AY | CGY | SM4T33CAY | CHY |
| SM4T35AY | CKY | SM4T35CAY | CLY |
| SM4T39AY | CMY | SM4T39CAY | CNY |
| SM4T47AY | DUZY | SM4T47CAY | DBZY |
| SM4T50AY | EUAY | SM4T50CAY | EBAY |
| SM4T56AY | CXY | SM4T56CAY | CYY |
| SM4T68AY | EUFY | SM4T68CAY | EBFY |
| SM4T82AY | EUIY | SM4T82CAY | EBIY |

5 Ordering information

Table 5. Ordering information

| Order code | Marking | Package | Weight | Base qty | Delivery mode |
|------------------------------|--|---------|---------|----------|---------------|
| SM4TxxxAY/CAY ⁽¹⁾ | See Table 4 on page 10 | SMA | 0.072 g | 5000 | Tape and reel |

1. Where xxx is nominal value of V_{BR} and A or CA indicates unidirectional or bidirectional version. See [Table 2](#) for list of available devices and their order codes

6 Revision history

Table 6. Document revision history

| Date | Revision | Changes |
|-------------|----------|--|
| 08-Sep-2010 | 1 | Initial release. |
| 09-Nov-2011 | 2 | Added order codes in Table 2 and Table 4 . Updated Figure 5, 6 and 7 . |
| 27-Mar-2012 | 3 | Added footnote on page 1. |

Please Read Carefully:

Information in this document is provided solely in connection with ST products. STMicroelectronics NV and its subsidiaries ("ST") reserve the right to make changes, corrections, modifications or improvements, to this document, and the products and services described herein at any time, without notice.

All ST products are sold pursuant to ST's terms and conditions of sale.

Purchasers are solely responsible for the choice, selection and use of the ST products and services described herein, and ST assumes no liability whatsoever relating to the choice, selection or use of the ST products and services described herein.

No license, express or implied, by estoppel or otherwise, to any intellectual property rights is granted under this document. If any part of this document refers to any third party products or services it shall not be deemed a license grant by ST for the use of such third party products or services, or any intellectual property contained therein or considered as a warranty covering the use in any manner whatsoever of such third party products or services or any intellectual property contained therein.

UNLESS OTHERWISE SET FORTH IN ST'S TERMS AND CONDITIONS OF SALE ST DISCLAIMS ANY EXPRESS OR IMPLIED WARRANTY WITH RESPECT TO THE USE AND/OR SALE OF ST PRODUCTS INCLUDING WITHOUT LIMITATION IMPLIED WARRANTIES OF MERCHANTABILITY, FITNESS FOR A PARTICULAR PURPOSE (AND THEIR EQUIVALENTS UNDER THE LAWS OF ANY JURISDICTION), OR INFRINGEMENT OF ANY PATENT, COPYRIGHT OR OTHER INTELLECTUAL PROPERTY RIGHT.

UNLESS EXPRESSLY APPROVED IN WRITING BY TWO AUTHORIZED ST REPRESENTATIVES, ST PRODUCTS ARE NOT RECOMMENDED, AUTHORIZED OR WARRANTED FOR USE IN MILITARY, AIR CRAFT, SPACE, LIFE SAVING, OR LIFE SUSTAINING APPLICATIONS, NOR IN PRODUCTS OR SYSTEMS WHERE FAILURE OR MALFUNCTION MAY RESULT IN PERSONAL INJURY, DEATH, OR SEVERE PROPERTY OR ENVIRONMENTAL DAMAGE. ST PRODUCTS WHICH ARE NOT SPECIFIED AS "AUTOMOTIVE GRADE" MAY ONLY BE USED IN AUTOMOTIVE APPLICATIONS AT USER'S OWN RISK.

Resale of ST products with provisions different from the statements and/or technical features set forth in this document shall immediately void any warranty granted by ST for the ST product or service described herein and shall not create or extend in any manner whatsoever, any liability of ST.

ST and the ST logo are trademarks or registered trademarks of ST in various countries.

Information in this document supersedes and replaces all information previously supplied.

The ST logo is a registered trademark of STMicroelectronics. All other names are the property of their respective owners.

© 2012 STMicroelectronics - All rights reserved

STMicroelectronics group of companies

Australia - Belgium - Brazil - Canada - China - Czech Republic - Finland - France - Germany - Hong Kong - India - Israel - Italy - Japan - Malaysia - Malta - Morocco - Philippines - Singapore - Spain - Sweden - Switzerland - United Kingdom - United States of America

www.st.com