

# MBRB20...CTPbF MBR20...CT-1PbF

SCHOTTKY RECTIFIER

20 Amp

$$I_{F(AV)} = 20\text{Amp}$$

$$V_R = 80/100\text{V}$$

### Major Ratings and Characteristics

Characteristics	Values	Units
$I_{F(AV)}$ Rectangular waveform (Per Device)	20	A
$I_{FRM}$ @ $T_C = 133^\circ\text{C}$ (PerLeg)	20	A
$V_{RRM}$	80/90/100	V
$I_{FSM}$ @ $t_p = 5\ \mu\text{s}$ sine	850	A
$V_F$ @ 10Apk, $T_J = 125^\circ\text{C}$	0.70	V
$T_J$ range	-65 to 150	$^\circ\text{C}$

### Description/ Features

This center tap Schottky rectifier has been optimized for low reverse leakage at high temperature. The proprietary barrier technology allows for reliable operation up to  $150^\circ\text{C}$  junction temperature. Typical applications are in switching power supplies, converters, free-wheeling diodes, and reverse battery protection.

- $150^\circ\text{C}$   $T_J$  operation
- Center tap TO-220, D<sup>2</sup>Pak and TO-262 packages
- Low forward voltage drop
- High purity, high temperature epoxy encapsulation for enhanced mechanical strength and moisture resistance
- High frequency operation
- Guard ring for enhanced ruggedness and long term reliability

### Case Styles

MBRB20...CTPbF

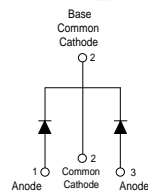
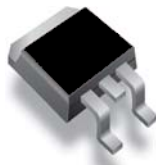

**D<sup>2</sup>PAK**

MBR20...CT-1PbF

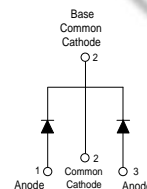
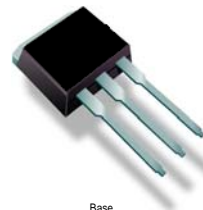

**TO-262**

**MBRB20...CTPbF, MBR20...CT-1PbF Series**

Bulletin PD-21019 rev. C 01/07

**Voltage Ratings**

Parameters	MBRB2080CTPbF MBR2080CT-1PbF	MBRB2090CTPbF MBR2090CT-1PbF	MBRB20100CTPbF MBR20100CT-1PbF
V <sub>R</sub> Max. DC Reverse Voltage (V)	80	90	100
V <sub>RWM</sub> Max. Working Peak Reverse Voltage (V)			

**Absolute Maximum Ratings**

Parameters	Values	Units	Conditions
I <sub>F(AV)</sub> Max. Average Forward Current (PerLeg) (PerDevice)	10	A	@ T <sub>C</sub> = 133°C, (Rated V <sub>R</sub> )
	20		
I <sub>FRM</sub> Peak Repetitive Forward Current (Per Leg)	20	A	Rated V <sub>R</sub> , squarewave, 20kHz T <sub>C</sub> = 133°C
I <sub>FSM</sub> Non Repetitive Peak Surge Current	850	A	5µs. Sine or 3µs Rect. pulse Following any rated load condition and with rated V <sub>RRM</sub> applied Surge applied at rated load conditions halfwave, single phase, 60Hz
	150		
I <sub>RRM</sub> Peak Repetitive Reverse Surge Current	0.5	A	2.0 µsec 1.0KHz
E <sub>AS</sub> Non-Repetitive Avalanche Energy (PerLeg)	24	mJ	T <sub>J</sub> = 25°C, I <sub>AS</sub> = 2 Amps, L = 12 mH

**Electrical Specifications**

Parameters	Values	Units	Conditions
V <sub>FM</sub> Max. Forward Voltage Drop (1)	0.80	V	@ 10A T <sub>J</sub> = 25°C
	0.95	V	@ 20A
	0.70	V	@ 10A T <sub>J</sub> = 125°C
	0.85	V	@ 20A
I <sub>RM</sub> Max. Instantaneous Reverse Current (1)	0.10	mA	T <sub>J</sub> = 25°C
	6	mA	T <sub>J</sub> = 125°C Rated DC voltage
V <sub>F(TO)</sub> Threshold Voltage	0.433	V	T <sub>J</sub> = T <sub>J</sub> max.
r <sub>t</sub> Forward Slope Resistance	15.8	mΩ	
C <sub>T</sub> Max. Junction Capacitance	400	pF	V <sub>R</sub> = 5V <sub>DC</sub> (test signal range 100Khz to 1Mhz) 25°C
L <sub>S</sub> Typical Series Inductance	8.0	nH	Measured from top of terminal to mounting plane
dv/dt Max. Voltage Rate of Change	10000	V/ µs	(Rated V <sub>R</sub> )

(1) Pulse Width < 300µs, Duty Cycle <2%

**Thermal-Mechanical Specifications**

Parameters	Values	Units	Conditions
T <sub>J</sub> Max. Junction Temperature Range	-65 to 150	°C	
T <sub>stg</sub> Max. Storage Temperature Range	-65 to 175	°C	
R <sub>thJC</sub> Max. Thermal Resistance Junction to Case (Per Leg)	2.0	°C/W	DC operation
R <sub>thCS</sub> Typical Thermal Resistance Case to Heatsink	0.50	°C/W	Mounting surface, smooth and greased Only for TO-220
R <sub>thJA</sub> Max. Thermal Resistance Junction to Ambient	50	°C/W	DC operation For D <sup>2</sup> Pak and TO-262
wt Approximate Weight	2(0.07)	g(oz.)	
T Mounting Torque	Min. 6(5)	Kg-cm (lbf-in)	Non-lubricated threads
	Max. 12(10)		
Marking Device	MBRB20...CT	Case style D <sup>2</sup> Pak	
	MBR20...CT-1	Case style TO-262	

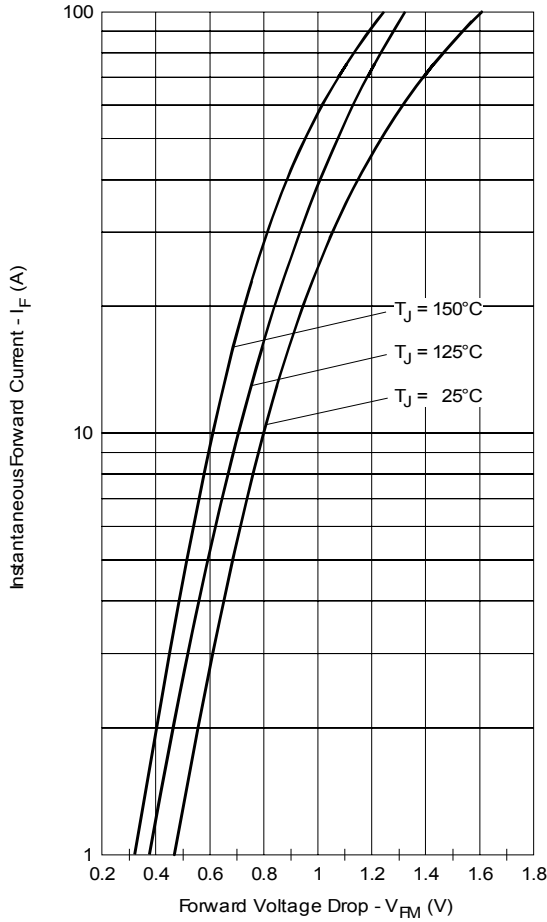

Fig. 1 - Max. Forward Voltage Drop Characteristics (PerLeg)

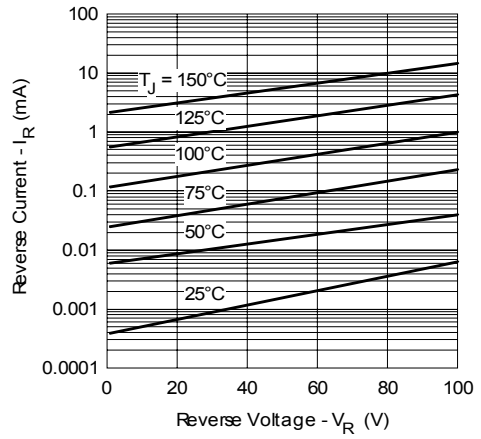

Fig. 2 - Typical Values Of Reverse Current Vs. Reverse Voltage (PerLeg)

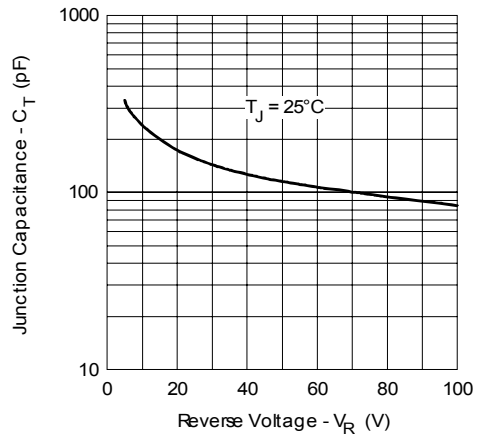

Fig. 3 - Typical Junction Capacitance Vs. Reverse Voltage (PerLeg)

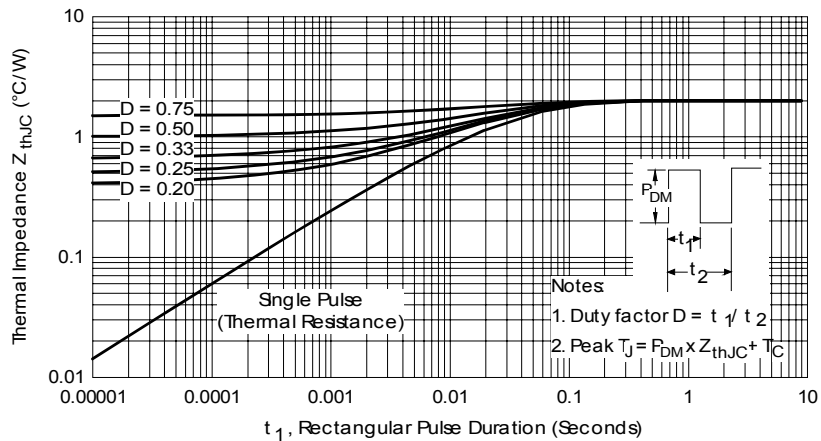

Fig. 4 - Max. Thermal Impedance  $Z_{thJC}$  Characteristics (PerLeg)

MBRB20...CTPbF, MBR20...CT-1PbF Series

Bulletin PD-21019 rev. C 01/07

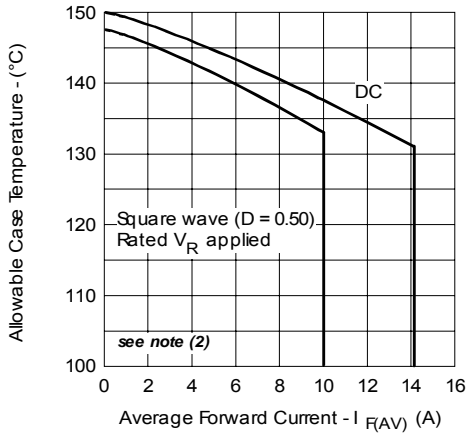

Fig. 5 - Max. Allowable Case Temperature Vs. Average Forward Current (Per Leg)

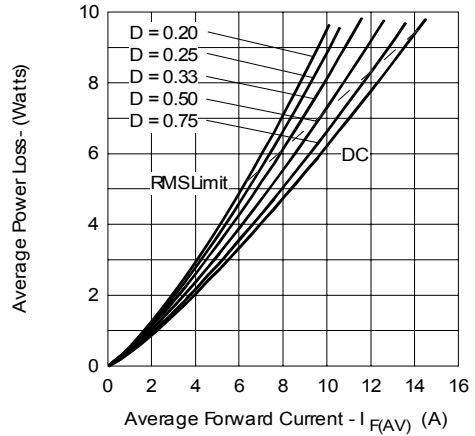

Fig. 6 - Forward Power Loss Characteristics (Per Leg)

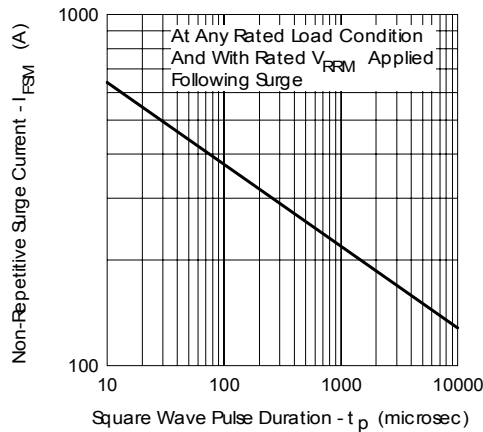
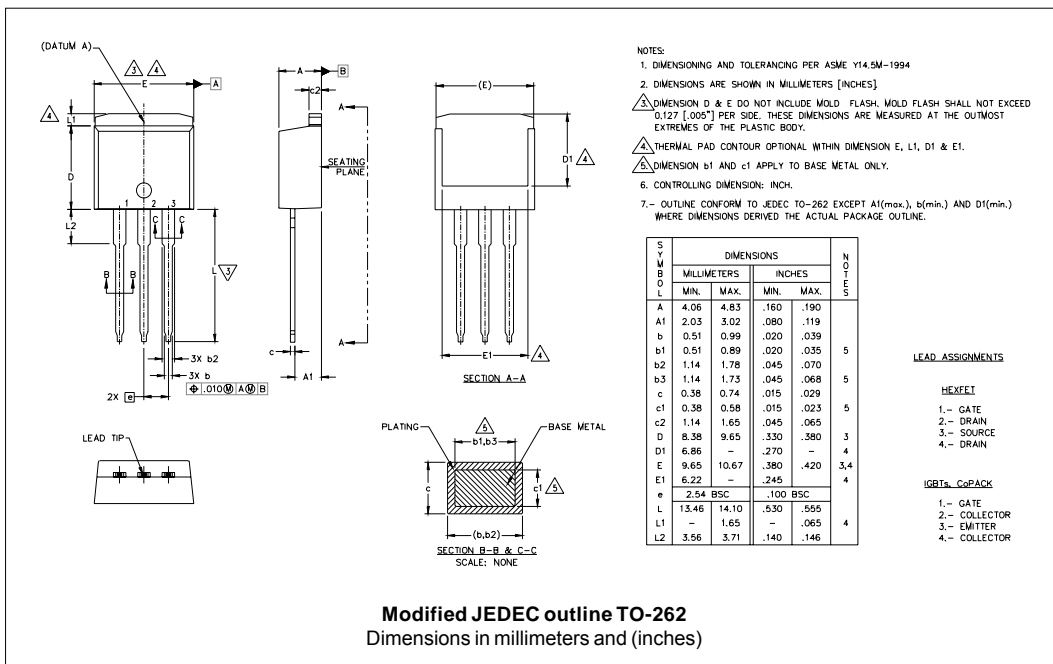
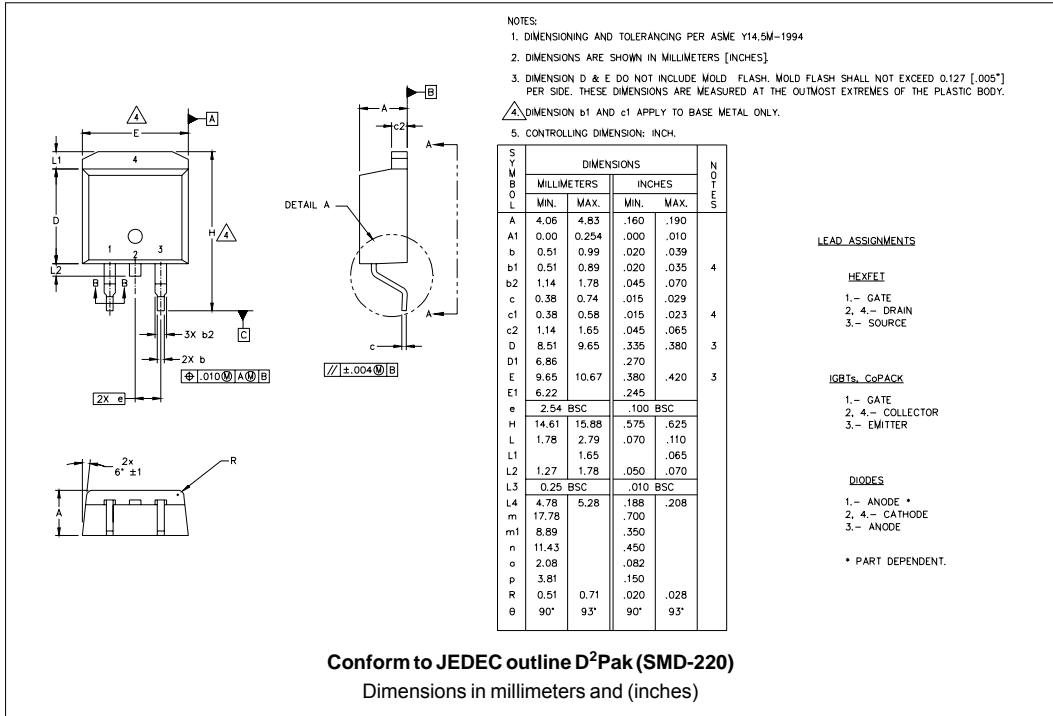

Fig. 7 - Max. Non-Repetitive Surge Current (Per Leg)

- (2) Formula used:  $T_C = T_J - (P_d + P_{d_{REV}}) \times R_{thJC}$ ;  
 $P_d = \text{Forward Power Loss} = I_{F(AV)} \times V_{FM} @ (I_{F(AV)} / D)$  (see Fig. 6);  
 $P_{d_{REV}} = \text{Inverse Power Loss} = V_{R1} \times I_R (1 - D)$ ;  $I_R @ V_{R1} = \text{rated } V_R$

Outlines Table



**MBRB20...CTPbF, MBR20...CT-1PbF Series**

Bulletin PD-21019 rev. C 01/07

**Part Marking Information**

**D<sup>2</sup>PAK**

EXAMPLE: THIS IS A MBRB20100CTPbF  
LOT CODE 8024  
ASSEMBLED ON WW 02, 2000

Note: "P" in assembly line position indicates "Lead-Free"

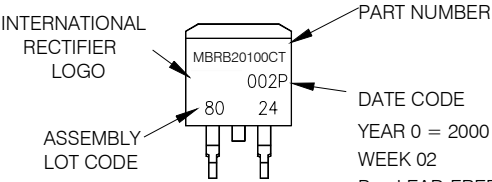

INTERNATIONAL RECTIFIER LOGO

PART NUMBER

DATE CODE  
YEAR 0 = 2000  
WEEK 02  
P = LEAD-FREE

ASSEMBLY LOT CODE

**TO-262**

EXAMPLE: THIS IS A MBR20100CT-1PbF  
LOT CODE 1789  
ASSEMBLED ON WW 19, 1999

Note: "P" in assembly line position indicates "Lead-Free"

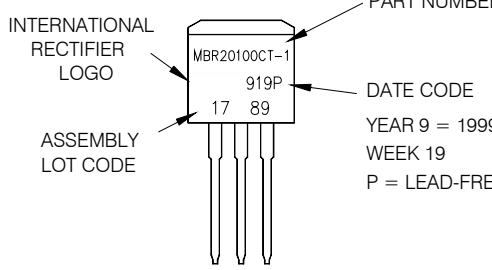

INTERNATIONAL RECTIFIER LOGO

PART NUMBER

DATE CODE  
YEAR 9 = 1999  
WEEK 19  
P = LEAD-FREE

ASSEMBLY LOT CODE

**Tape & Reel Information**

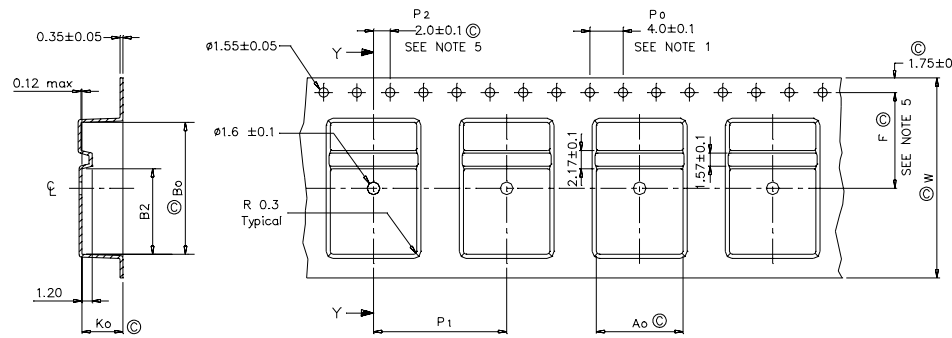

SECTION Y-Y

Ao	10.50	+/- 0.1
Bo	15.80	+/- 0.1
B2	10.25	+/- 0.1
Ko	4.90	+/- 0.1
F	11.50	+/- 0.1
P1	16.00	+/- 0.1
W	24.00	+/- 0.3

NOTES:

- 1.0 10 SPROCKET HOLE PITH CUMULATIVE TOLERANCE ±.02
- 2.0 CAMBER NOT TO EXCEED 1mm In 100mm
- 3.0 MATERIAL: CONDUCTIVE BLACK STYRENIC ALLOY
- 4.0 Ko MEASURED FROM A PLANE ON THE INSIDE BOTTOM OF THE POCKET TO THE TOP SURFACE OF THE CARRIER
- 5.0 MEASURED FROM CENTRELINE OF SPROCKET HOLE TO CENTRELINE OF POCKET
- 6.0 VENDOR: (OPTIONAL)
- 7.0 MUST ALSO MEET REQUIREMENTS OF EIA STANDAR #EIA-481A TAPING OF SURFACE MOUNT COMPONENTS FOR AUTOMATIC PLACEMENT
- 8.0 SURFACE RESISTIVITY OF MOLDED MATL. MUST MEASURE LESS OR EQUAL TO 10<sup>6</sup> OHMS PER SQUARE. MEASURED IN ACCORDANCE TO PROCEDURE GIVEN IN ASTM D-257 & ASTM D-991
- 9.0 TOTAL LENGTH PER REEL MUST BE 45 METERS
- 10.0 © CRITICAL

Dimensions in millimeters and (inches)

Ordering Information Table

Device Code							
<b>MBR</b>	<b>B</b>	<b>20</b>	<b>100</b>	<b>CT</b>	<b>-1</b>	<b>TRL</b>	<b>P</b>
①	②	③	④	⑤	⑥	⑦	⑧
<b>1</b>	- Essential Part Number						
<b>2</b>	-	• B = D <sup>2</sup> Pak	<b>6</b> none				
		• none = TO-262	<b>6</b> = -1				
<b>3</b>	- Current Rating (20 = 20A)						
<b>4</b>	- Voltage Ratings						
<b>5</b>	- CT = Essential Part Number						
<b>6</b>	-	• none = D <sup>2</sup> Pak	<b>2</b> = B				
		• -1 = TO-262	<b>2</b> none				
<b>7</b>	-	• none = Tube (50 pieces)					
		• TRL = Tape & Reel (Left Oriented - for D <sup>2</sup> Pak only)					
		• TRR = Tape & Reel (Right Oriented - for D <sup>2</sup> Pak only)					
<b>8</b>	-	• none = Standard Production					
		• PbF = Lead-Free (for TO-262 and D <sup>2</sup> Pak tube)					
		• P = Lead-Free (for D <sup>2</sup> Pak TRR and TRL)					

80 = 80V  
90 = 90V  
100 = 100V